



www.flitetest.com

FT Mini DR1

Designed By: Josh Bixler
 Drawing By: Dan Sponholz



SPECIFICATIONS

DESCRIPTION		IMPERIAL	METRIC
LENGTH		19.5 in	495.0 mm
CENTER OF GRAVITY	CG	1.83 in	46.5 mm
WING SPAN		24.3 in	618.2 mm
WING AREA		330.1 in ²	21.3 dm ²
DRY WEIGHT		9.3 oz	263.0 g
ALL UP WEIGHT	AUW	12.0 oz	340.0 g
WING LOADING	WL	5.2 oz/ft ²	16.0 g/dm ²
WING CUBIC LOADING	WCL	3.5	

RECOMMENDED SETTINGS

	THROW	EXPO
ELEVATOR	12°	30%
RUDDER	12°	30%

Build Skill Level :



Pilot Skill Level :



SHEET & TILE KEY

1	2	3	4
5	6	7	8

9	10	11	12
13	14	15	16



DRAWING KEY

FOLD TYPES

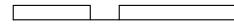
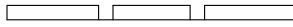
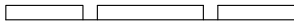
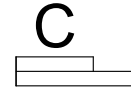
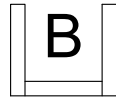
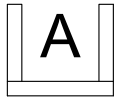

A - FOLD (ABOVE)

B - FOLD (BESIDE)

C - FOLD (COVER)

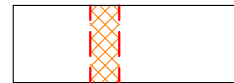
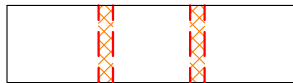
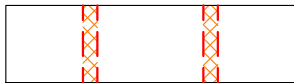

LINE TYPE/COLOR

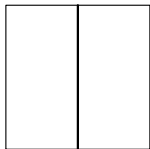

CUT

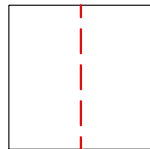
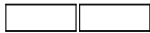

50% SCORE

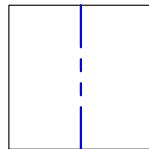
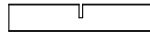

CREASE

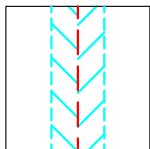
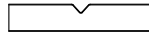

45° DOUBLE BEVEL

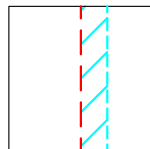

45° SINGLE BEVEL

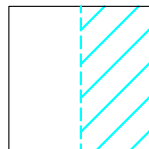

EDGE BEVEL

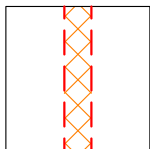

CAVITY

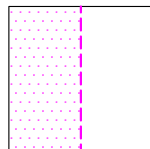

REMOVE PAPER

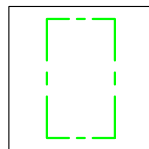
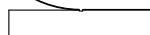

REFERENCE/
OPTIONAL

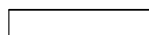

SYMBOLS

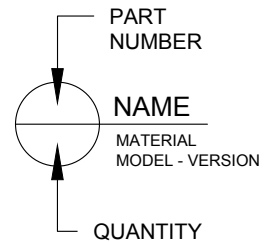

DOWEL HOLE



CENTER OF GRAVITY (CG)

FT Mini DR1

Designed By: Josh Bixler
Drawing By: Dan Sponholz



IN 
CM  SHEET 1 OF 2

Template Version 3.0.1

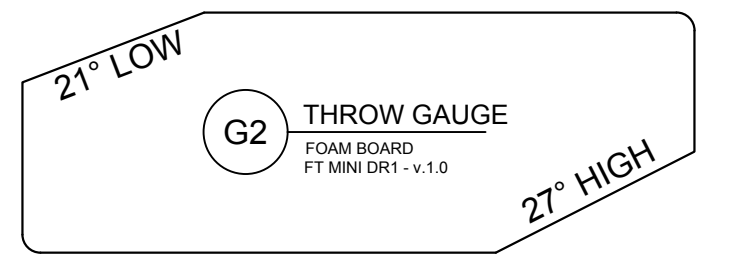
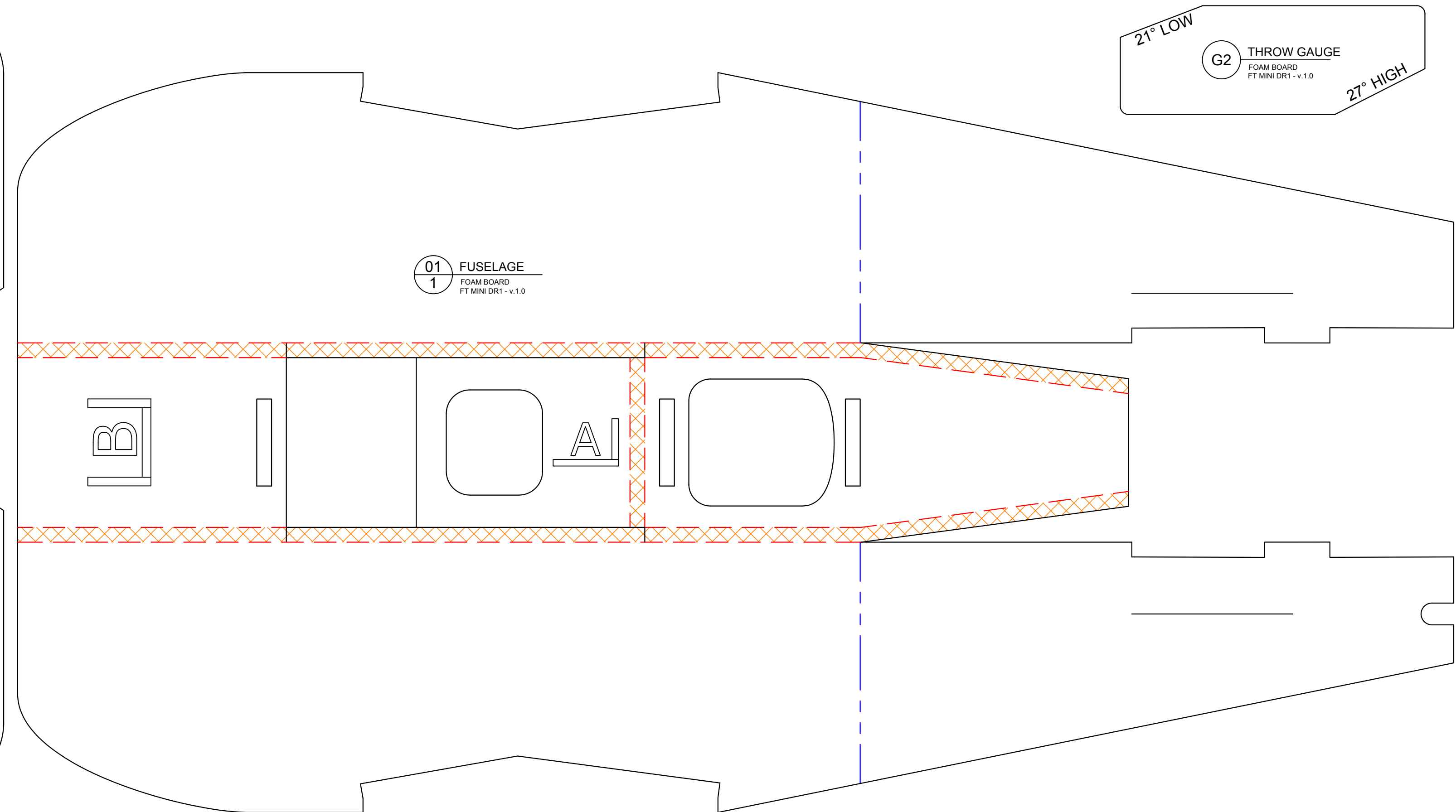
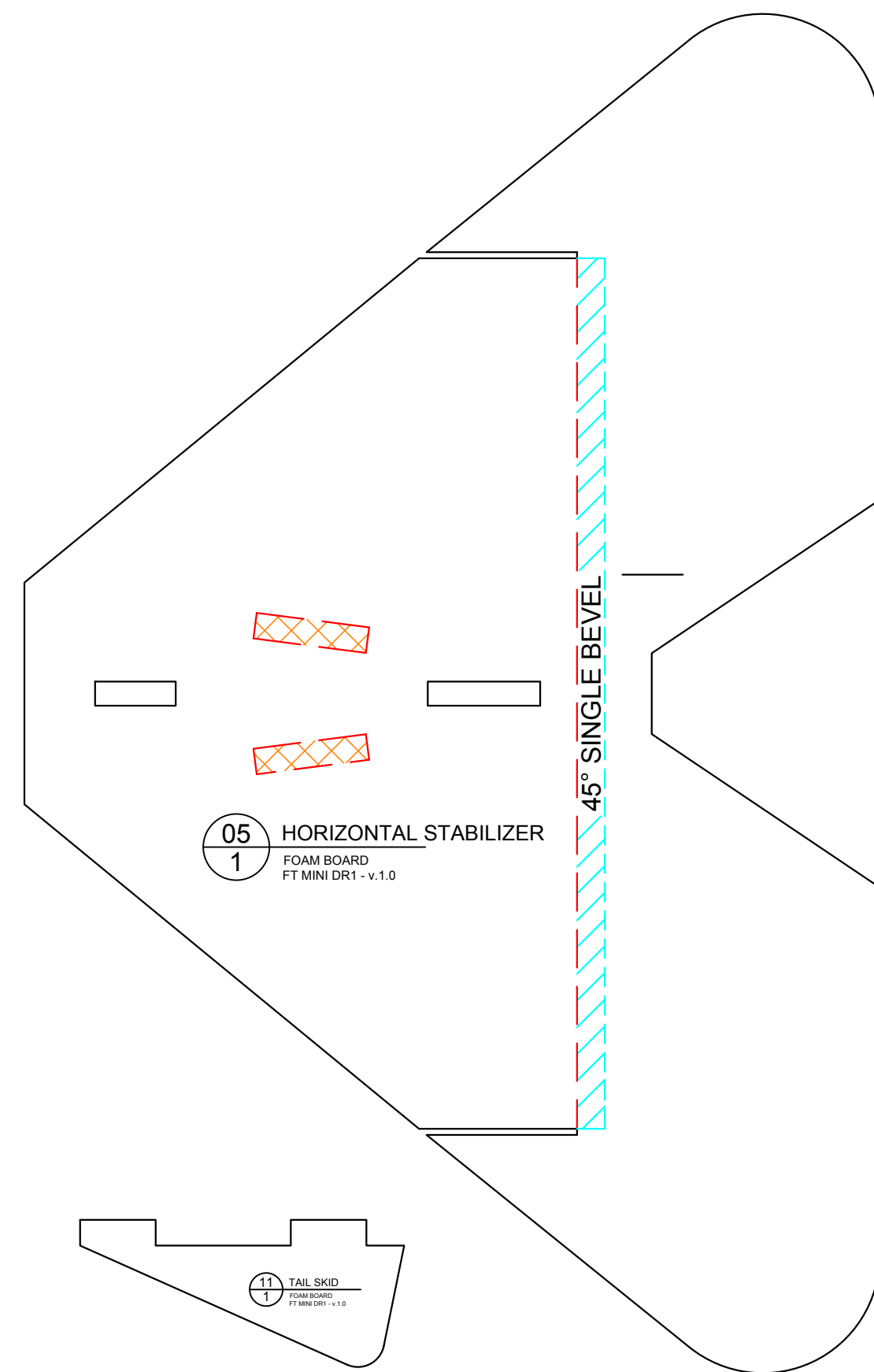
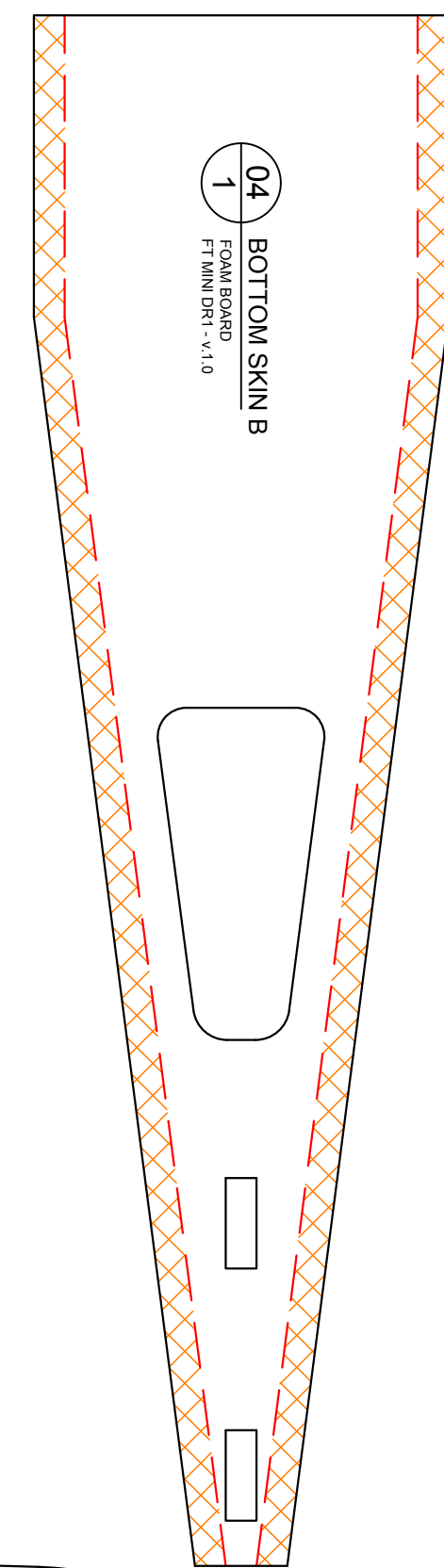
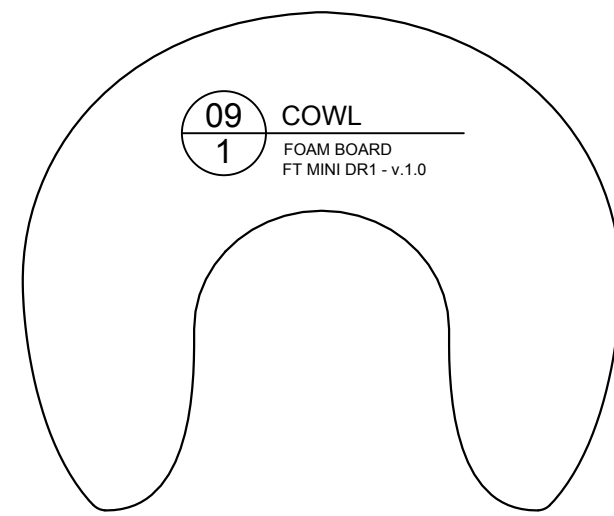
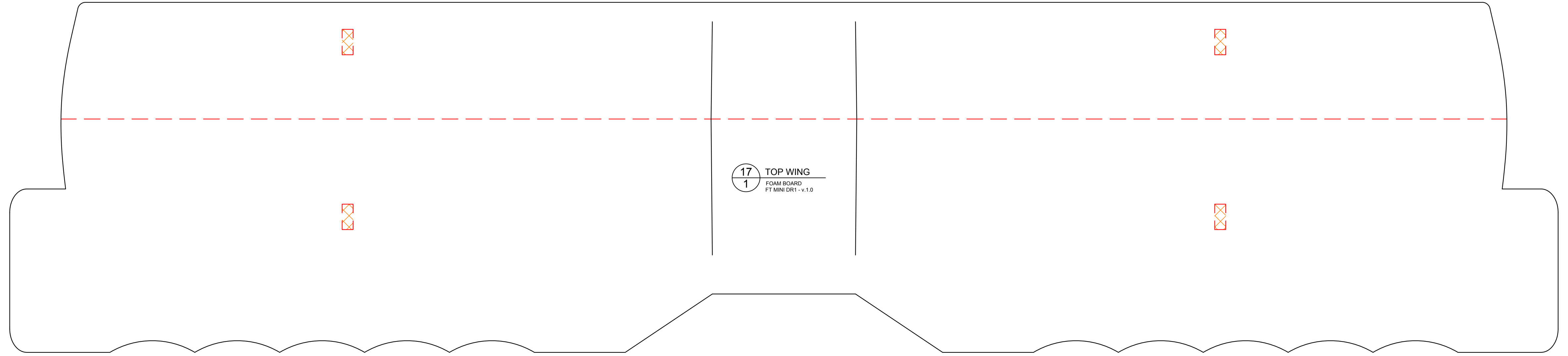
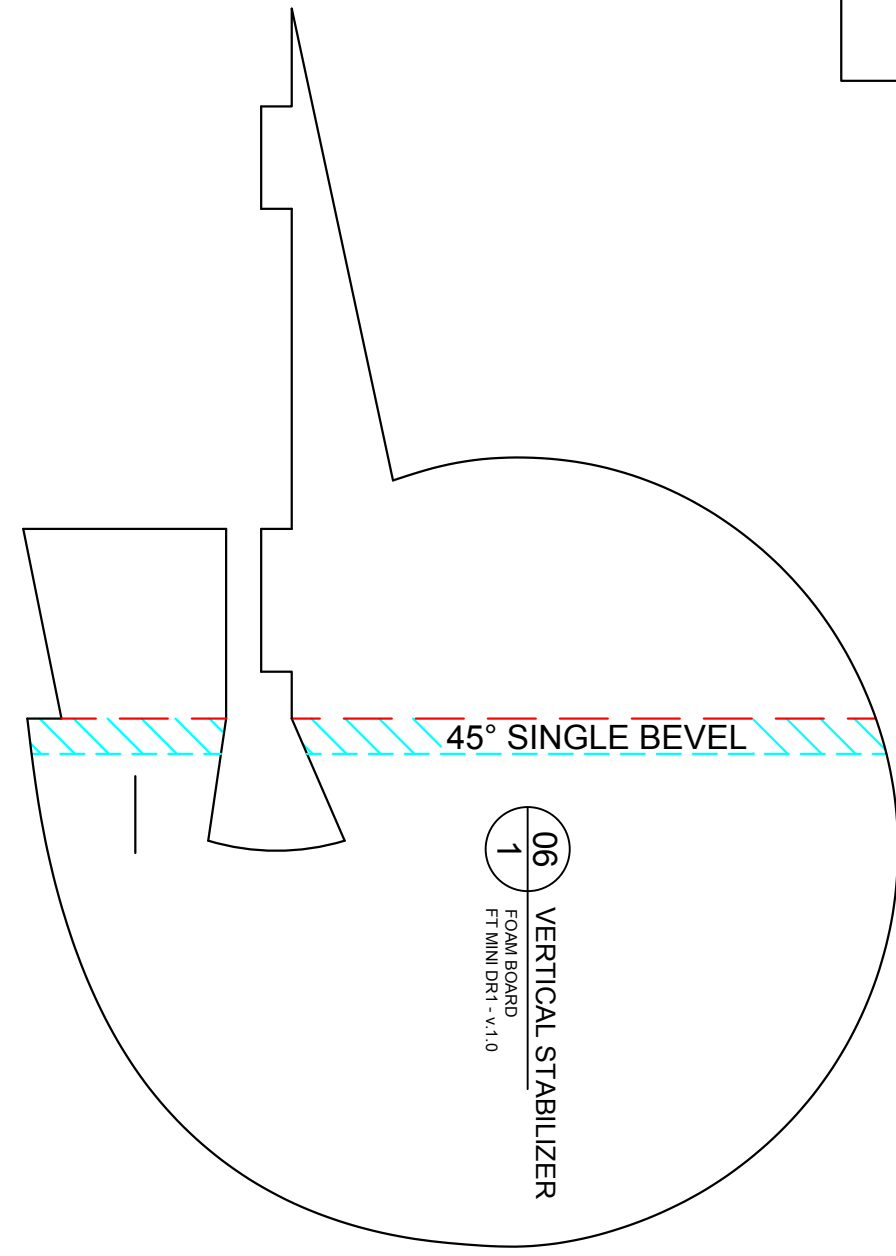
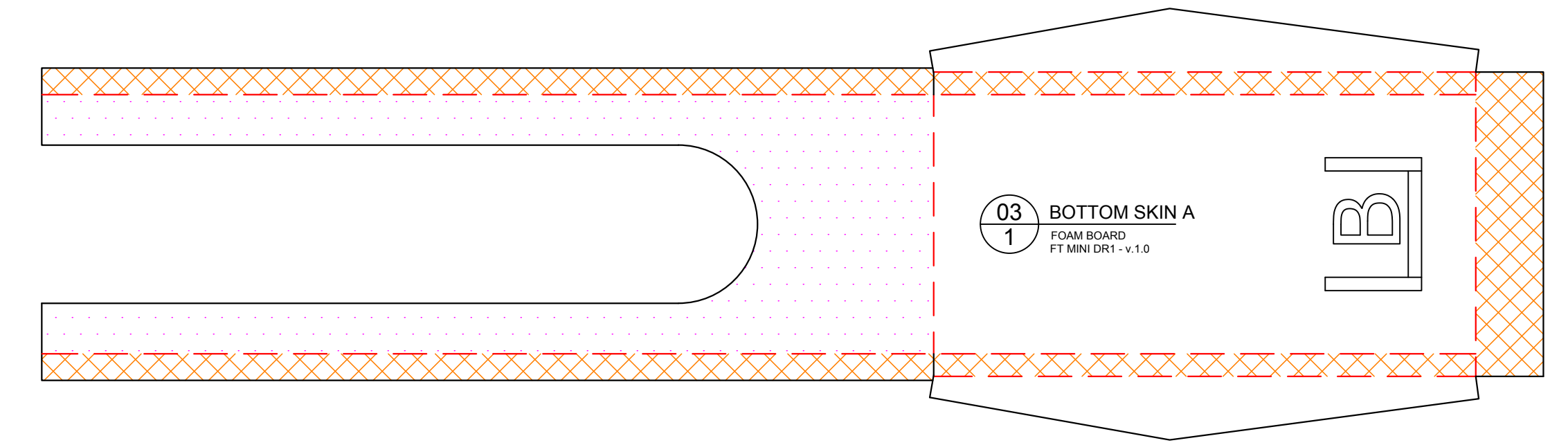
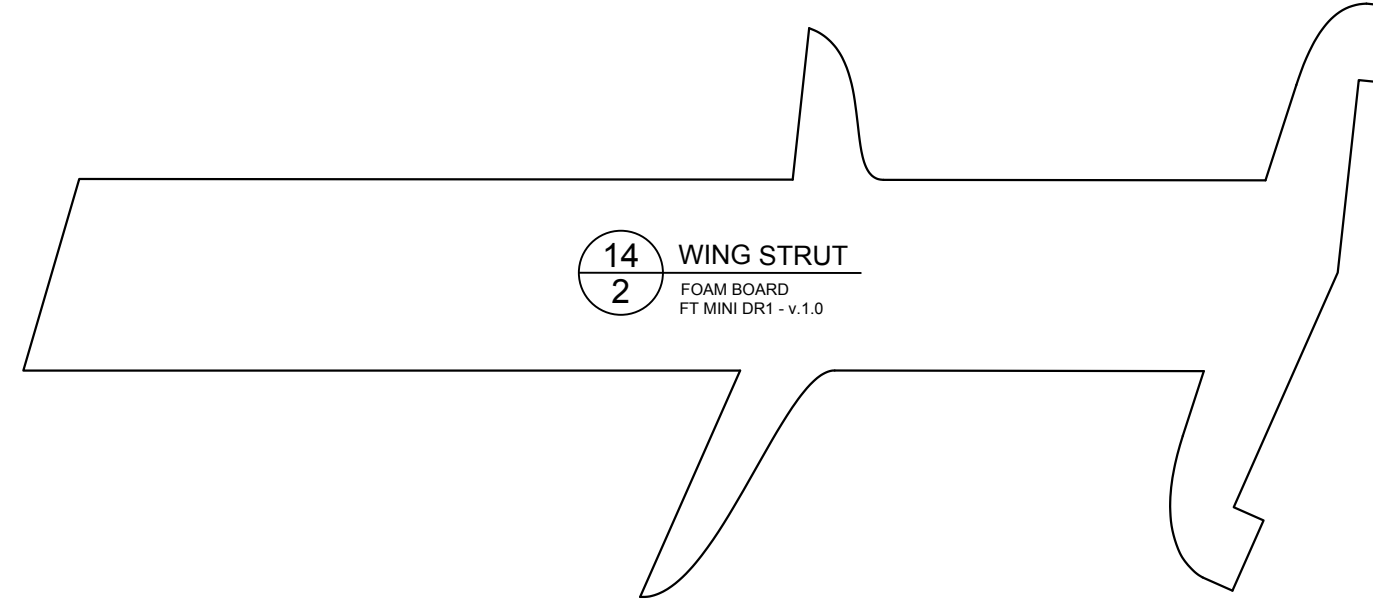
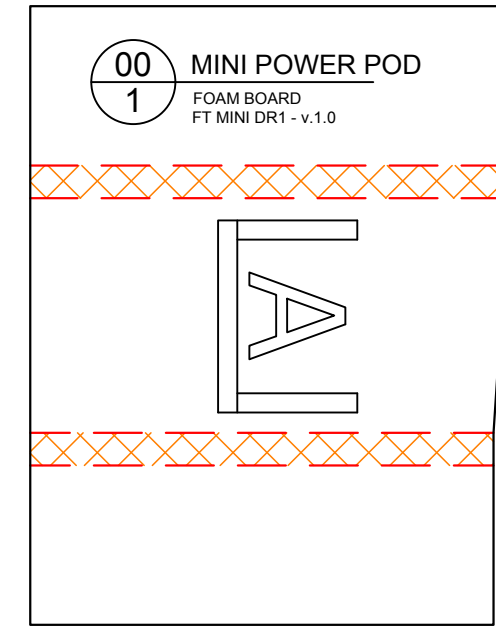

www.flitetest.com

© 2016 Flite Test, LLC. Plans provided free of charge. Copies allowed for personal use only. Not for commercial use.

