



www.flitetest.com

FT Mini DR1

Designed By: Josh Bixler
 Drawing By: Dan Sponholz



SPECIFICATIONS

DESCRIPTION		IMPERIAL	METRIC
LENGTH		19.5 in	495.0 mm
CENTER OF GRAVITY	CG	1.83 in	46.5 mm
WING SPAN		24.3 in	618.2 mm
WING AREA		330.1 in ²	21.3 dm ²
DRY WEIGHT		9.3 oz	263.0 g
ALL UP WEIGHT	AUW	12.0 oz	340.0 g
WING LOADING	WL	5.2 oz/ft ²	16.0 g/dm ²
WING CUBIC LOADING	WCL	3.5	

RECOMMENDED SETTINGS

	THROW	EXPO
ELEVATOR	12°	30%
RUDDER	12°	30%

Build Skill Level :



Pilot Skill Level :



SHEET & TILE KEY

1	2	3	4
5	6	7	8

9	10	11	12
13	14	15	16



DRAWING KEY

FOLD TYPES

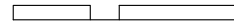
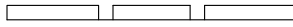
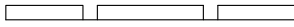
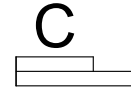
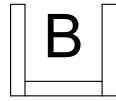
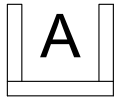

A - FOLD (ABOVE)

B - FOLD (BESIDE)

C - FOLD (COVER)

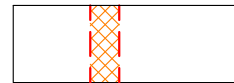
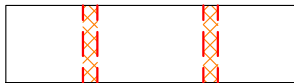

LINE TYPE/COLOR

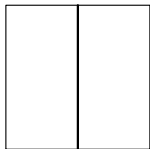

CUT

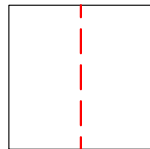

50% SCORE

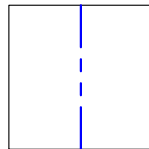
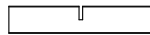

CREASE

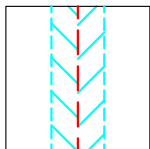
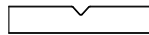

45° DOUBLE BEVEL

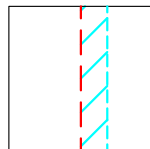

45° SINGLE BEVEL

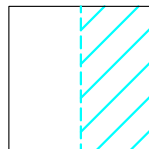

EDGE BEVEL

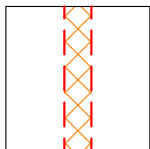

CAVITY

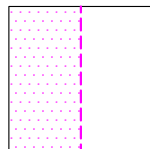

REMOVE PAPER

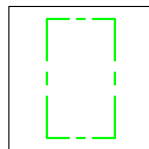

REFERENCE/
OPTIONAL

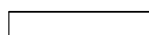

SYMBOLS

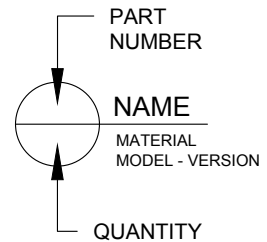

DOWEL HOLE



CENTER OF GRAVITY (CG)

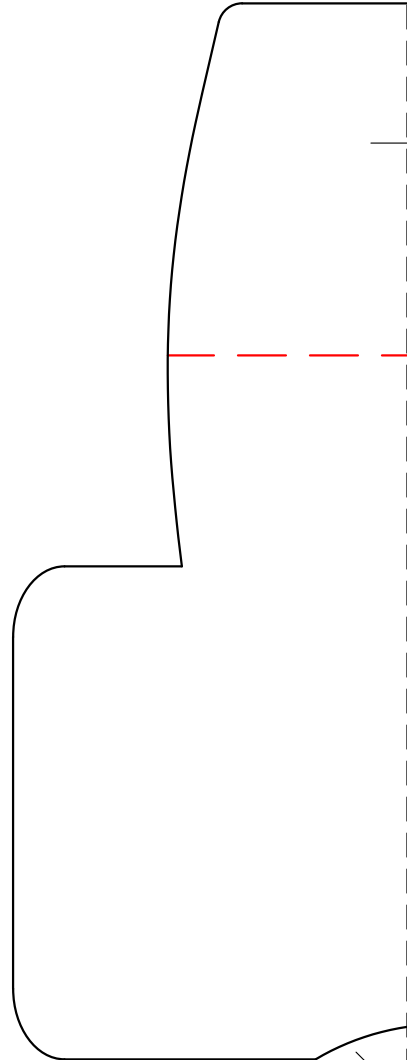
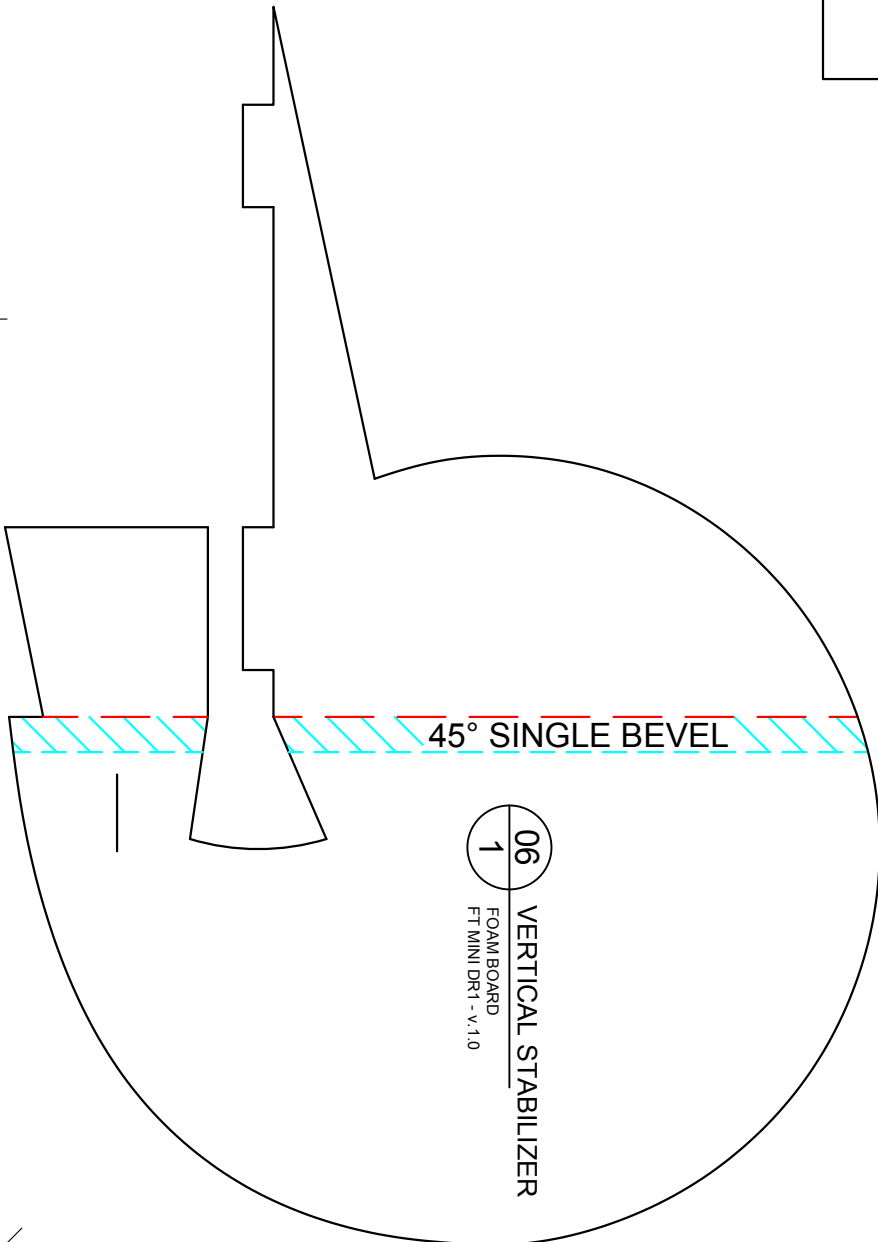
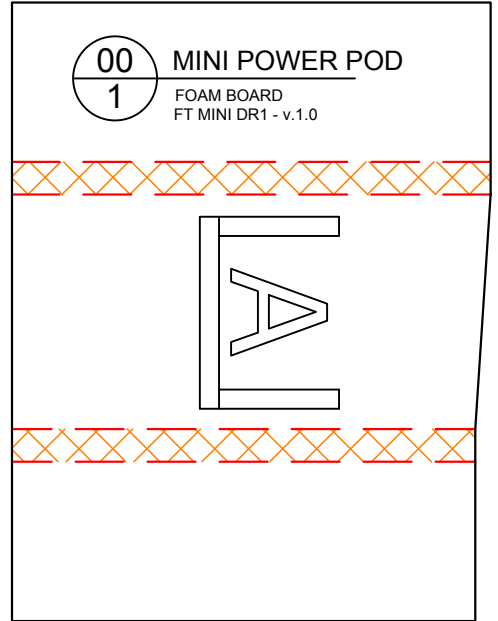

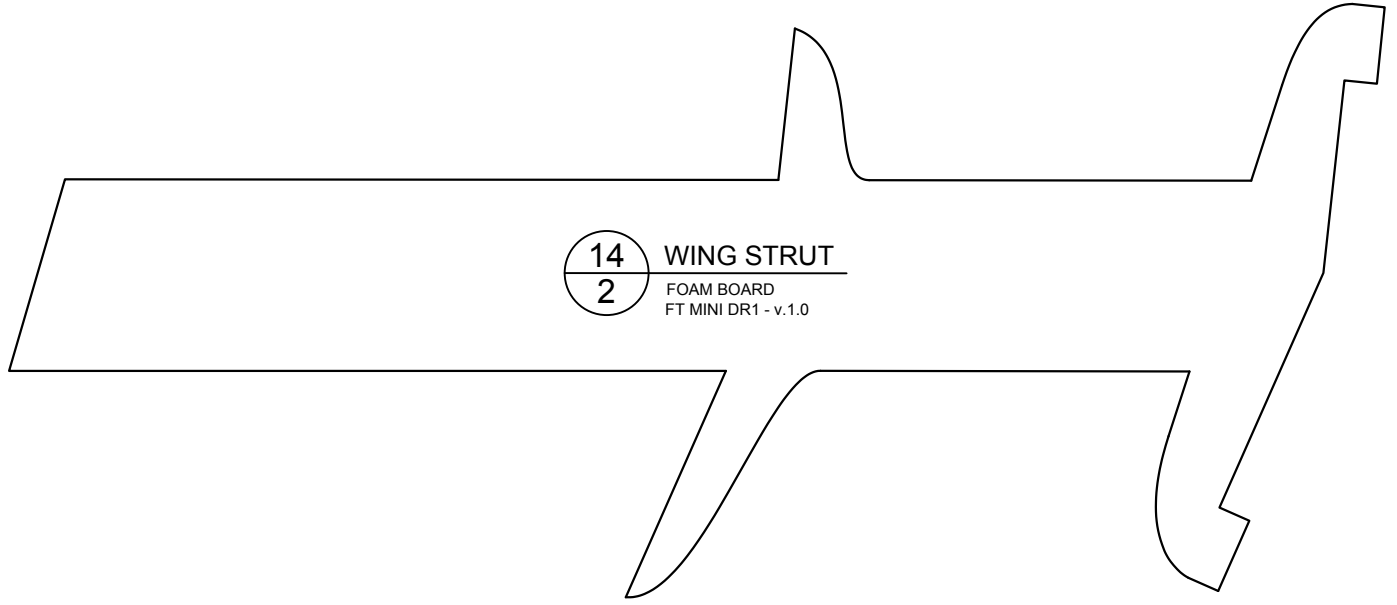

14 WING STRUT
2 FOAM BOARD
FT MINI DR1 - v.1.0



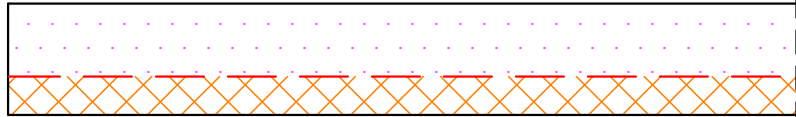
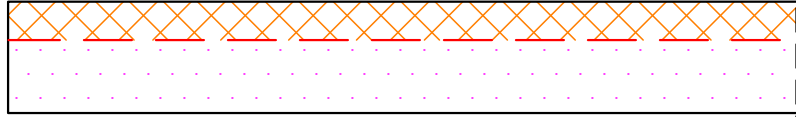

17
1 TOP WING
FOAM BOARD
FT MINI DR1 - v.1.0

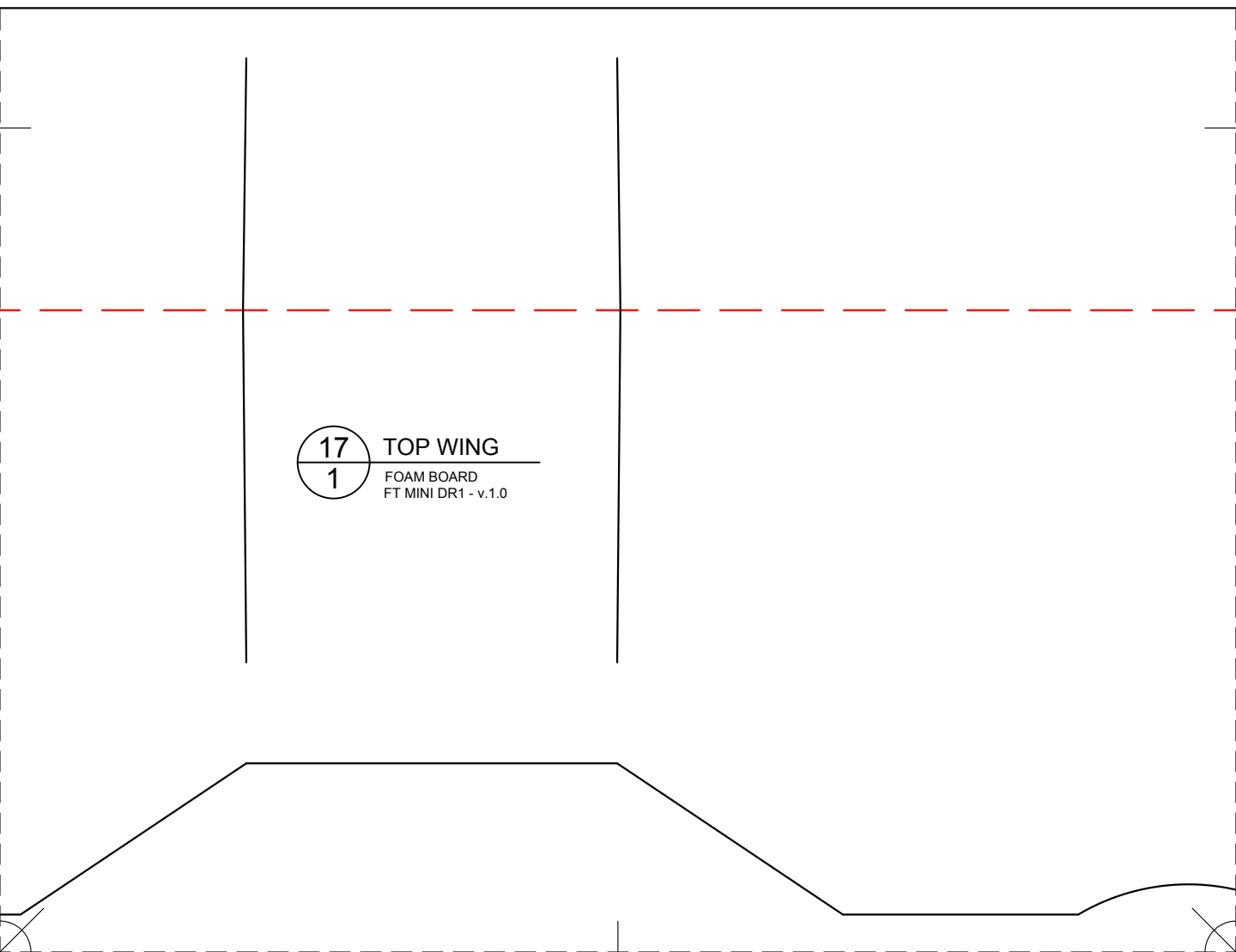

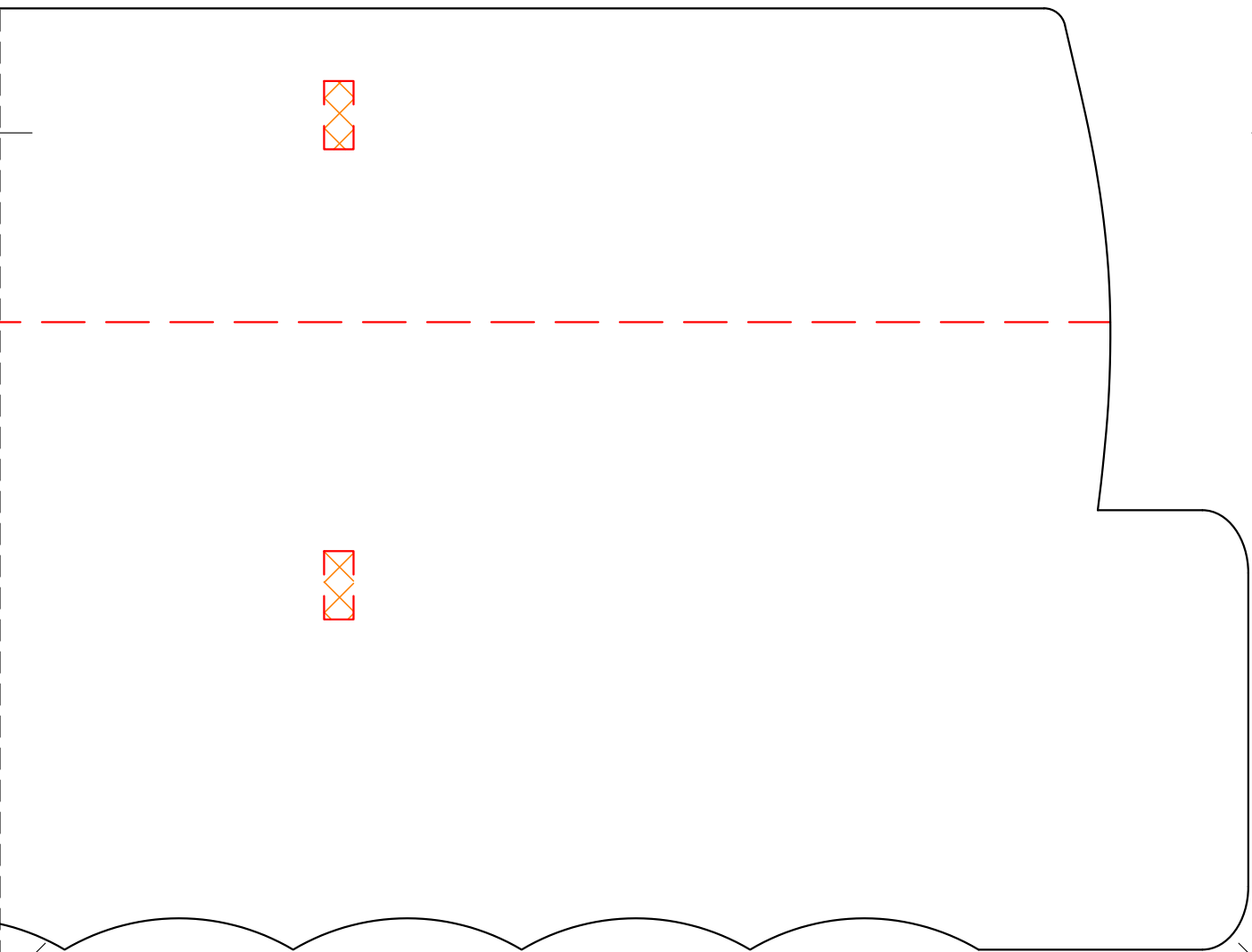
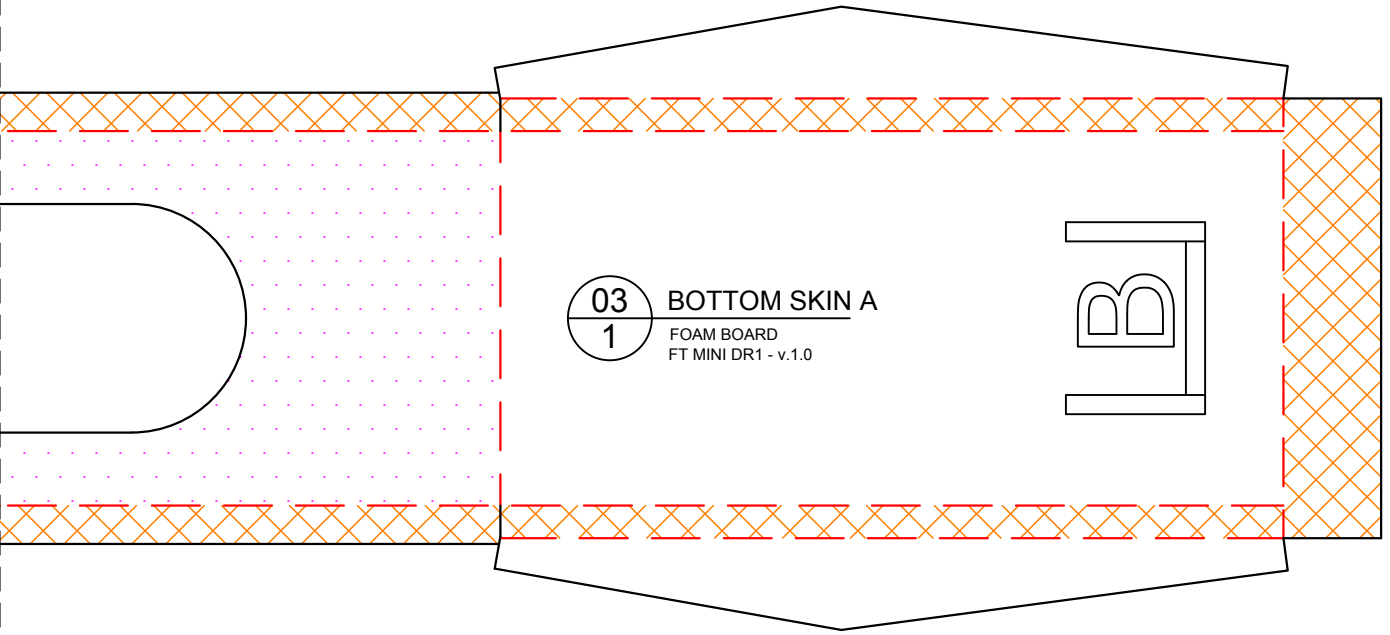

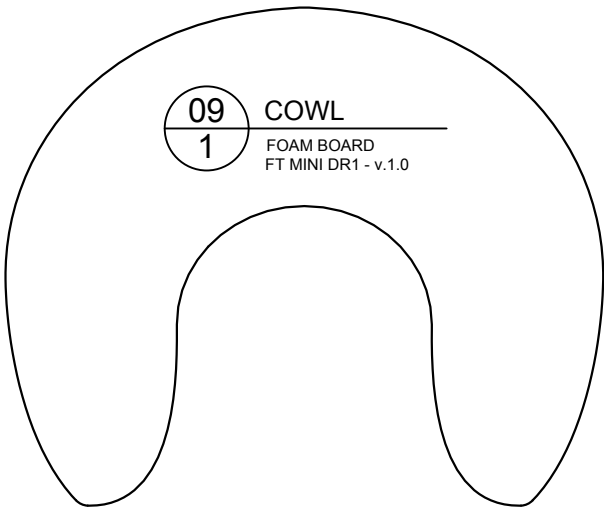

09
1

COWL
FOAM BOARD
FT MINI DR1 - v.1.0

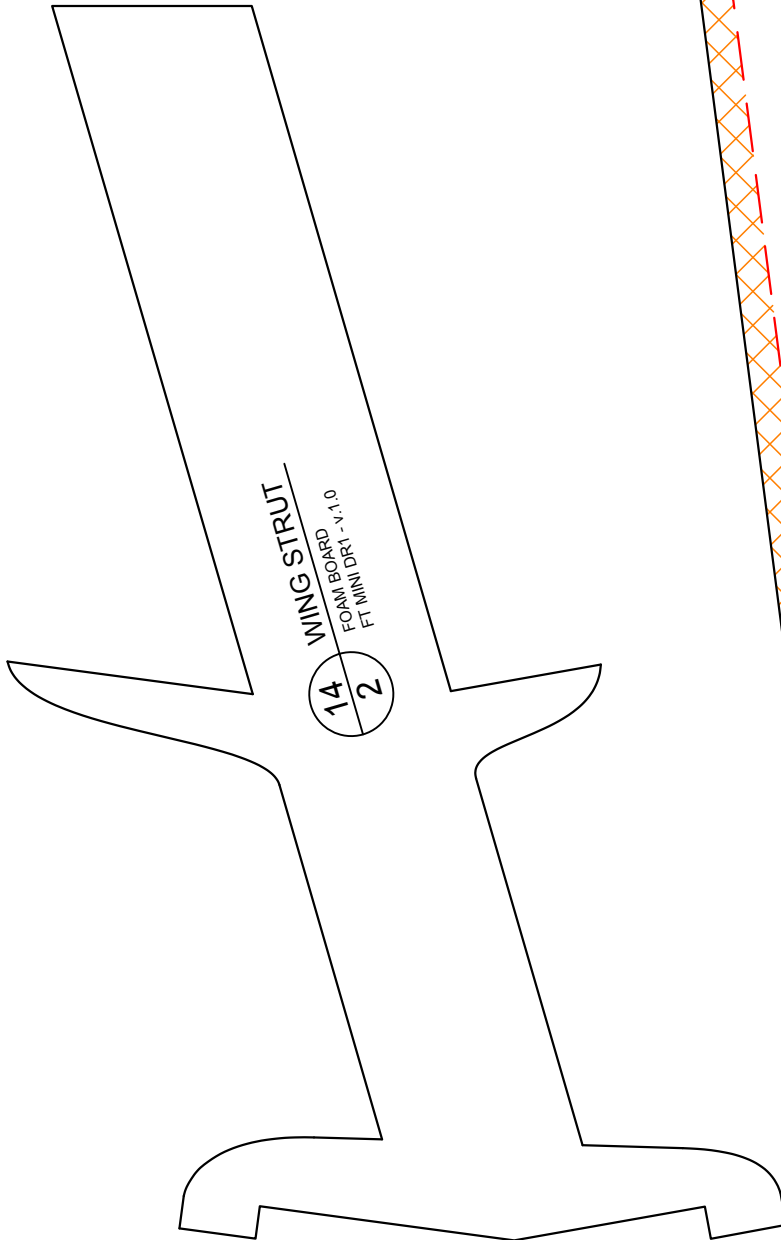

14
2

WING STRUT
FOAM BOARD
FT MINI DR1 - v.1.0

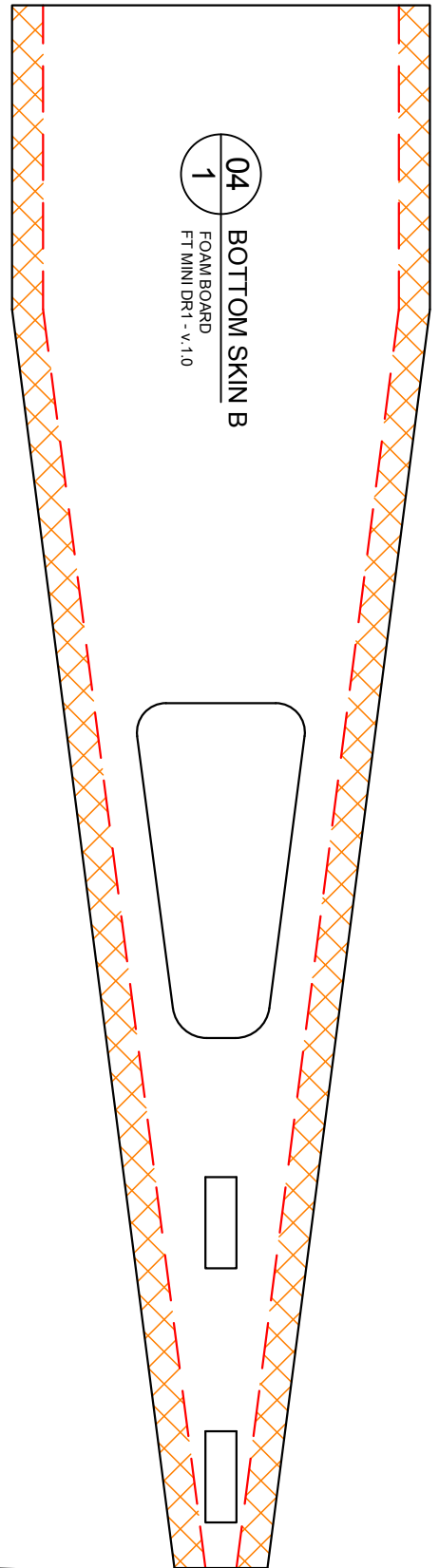

04
1

BOTTOM SKIN B
FOAM BOARD
FT MINI DR1 - v.1.0

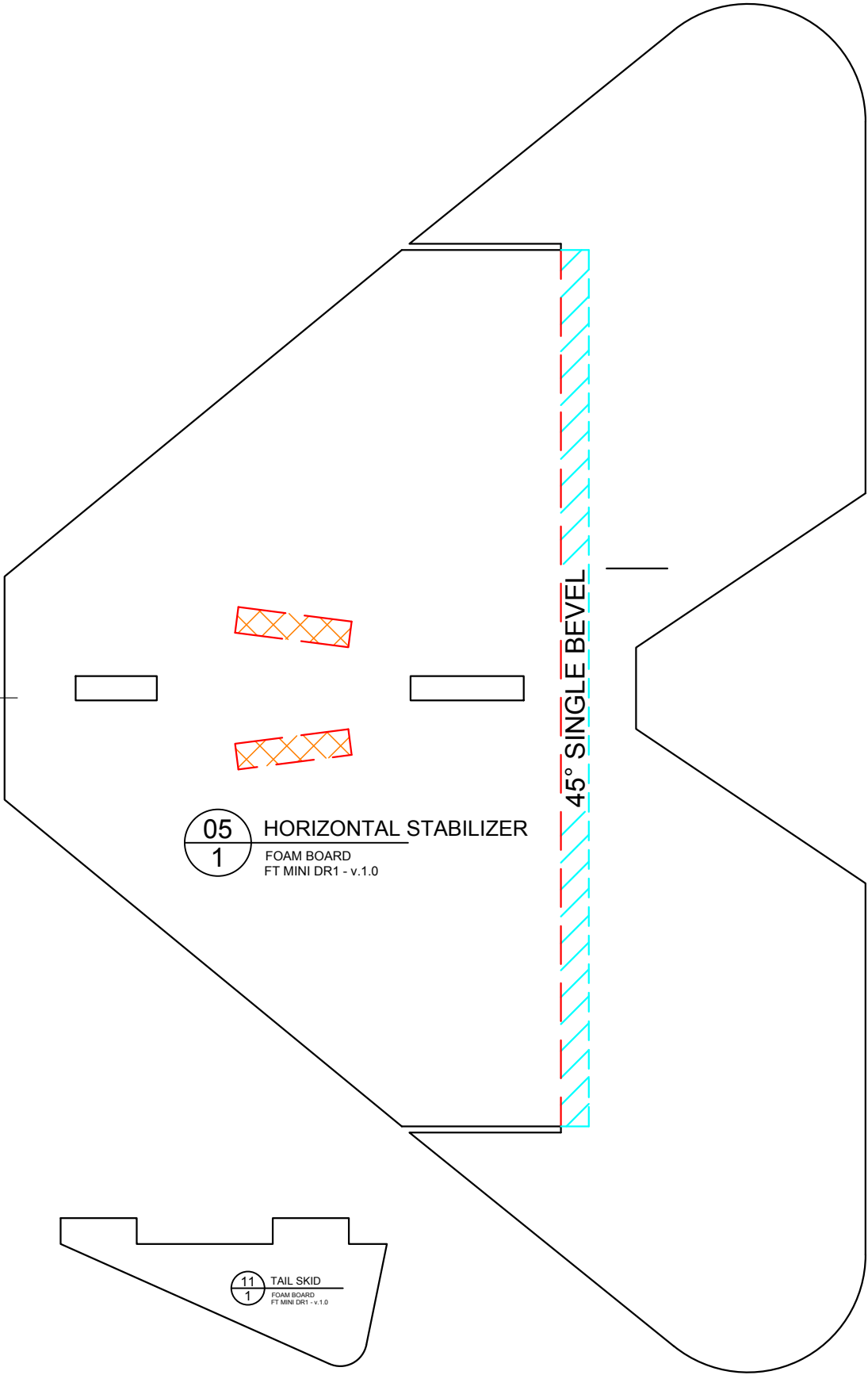

05
1

HORIZONTAL STABILIZER

FOAM BOARD
FT MINI DR1 - v.1.0

45° SINGLE BEVEL

B

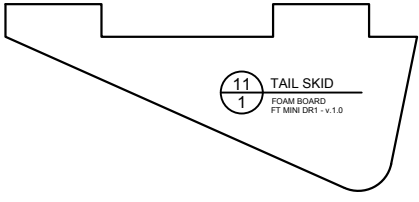

11
1

TAIL SKID

FOAM BOARD
FT MINI DR1 - v.1.0

01 FUSELAGE
1 FOAM BOARD
FT MINI DR1 - v.1.0

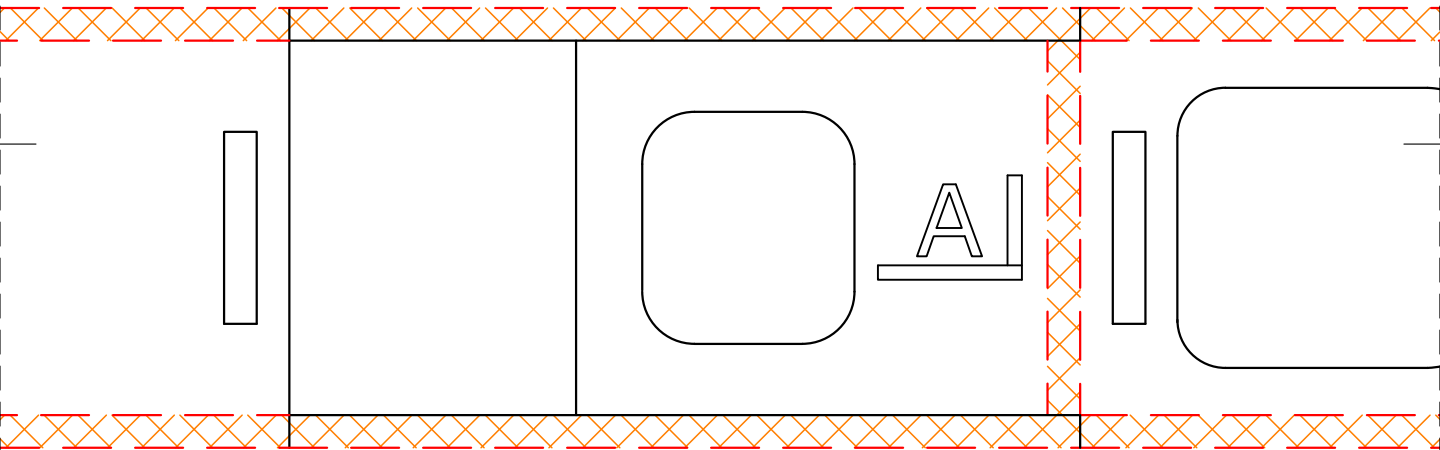

21° LOW

G2

THROW GAUGE

FOAM BOARD
FT MINI DR1 - v.1.0

27° HIGH

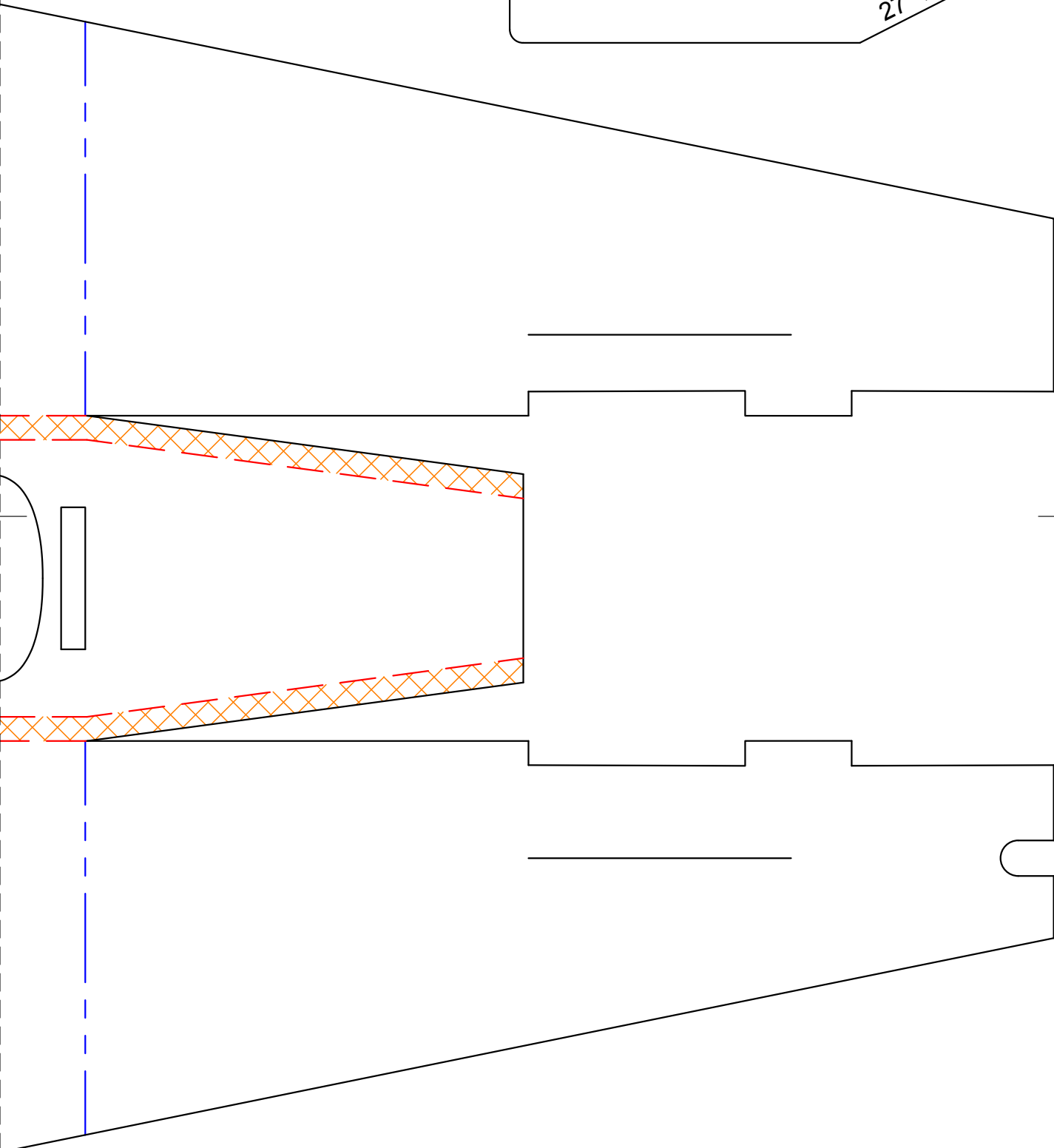

18 TURTLE DECK
1 POSTER BOARD
FT MINI DR1 - v.1.0

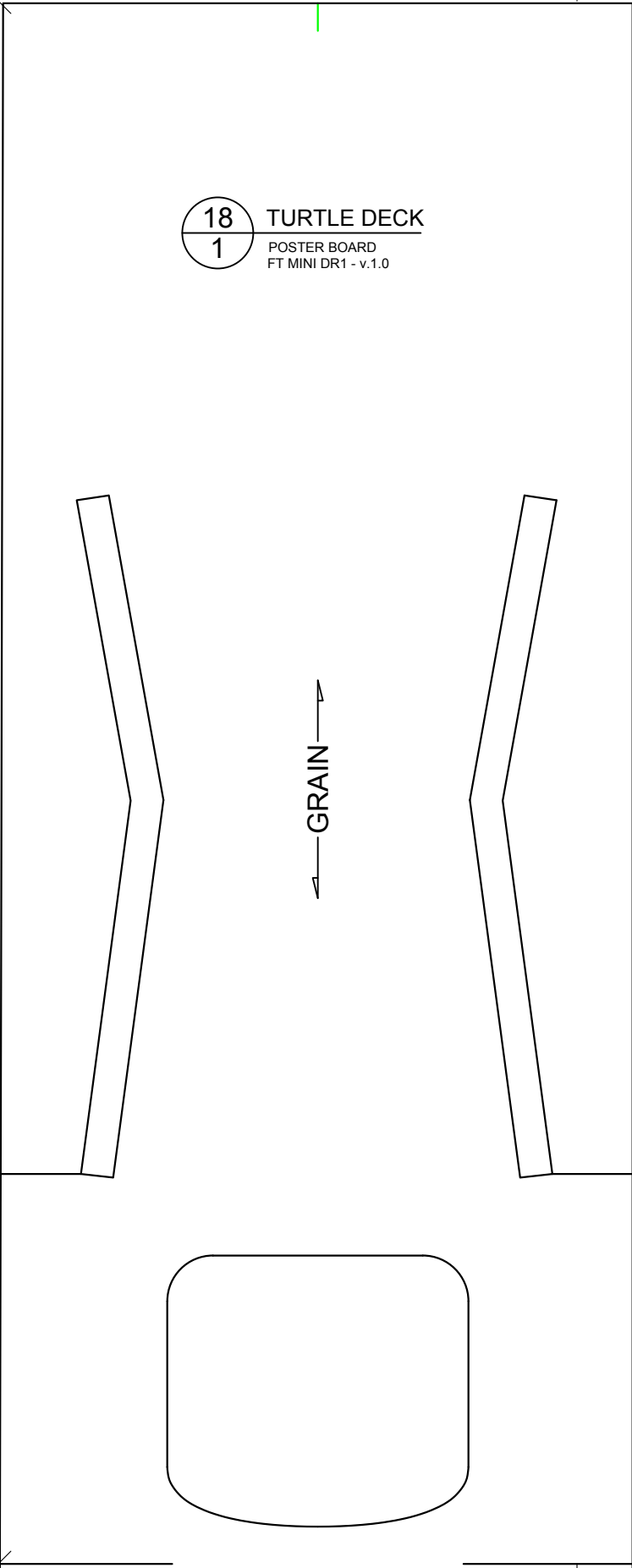

19 COWL SKIN
1 POSTER BOARD
FT MINI DR1 - v.1.0

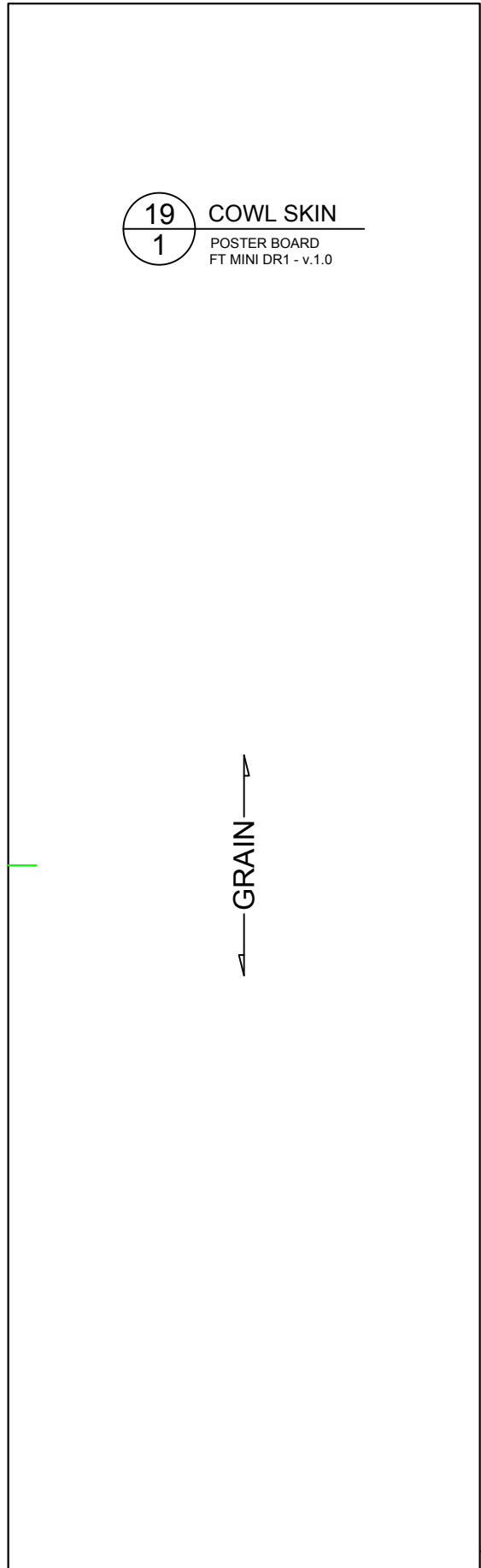

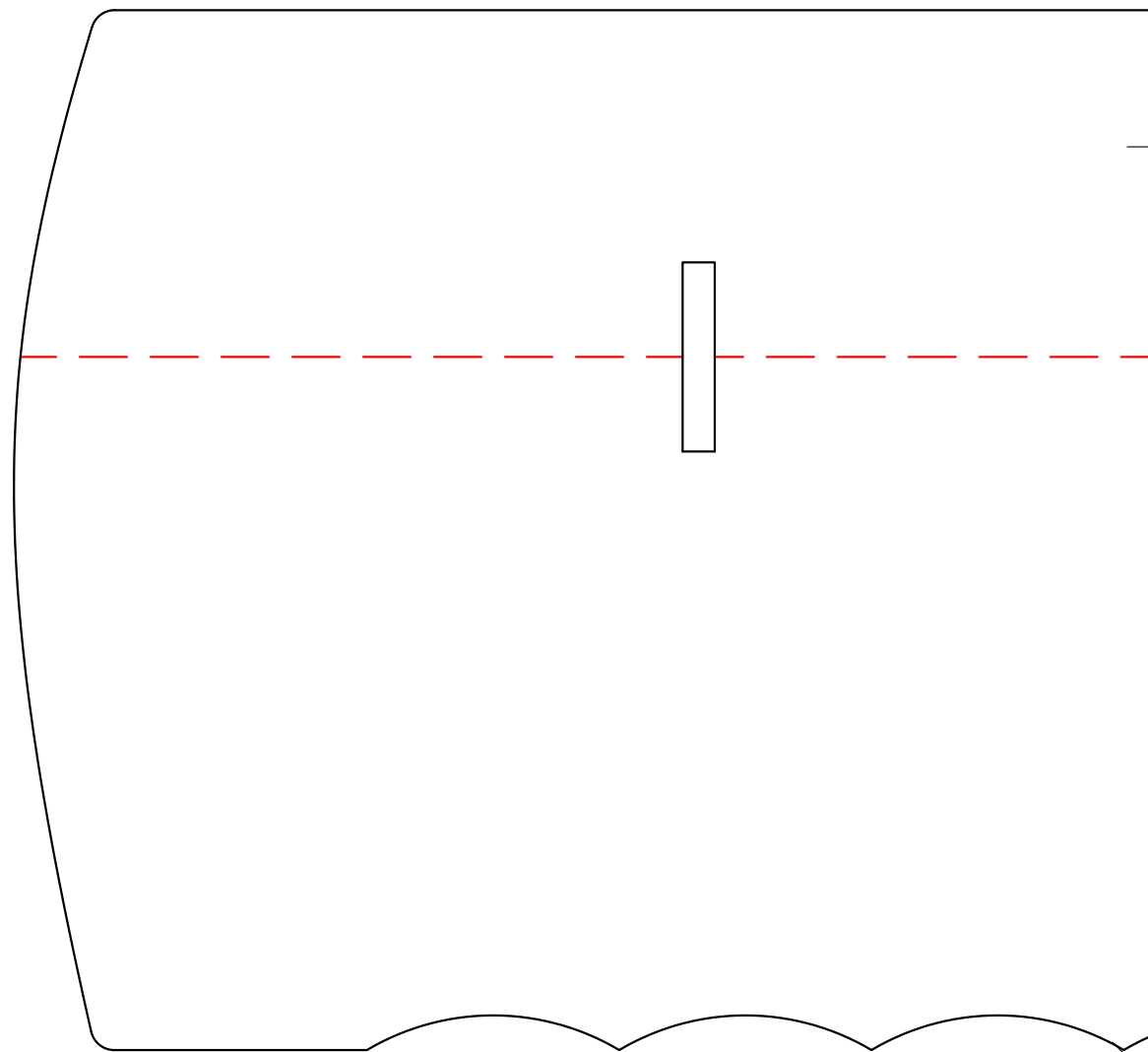
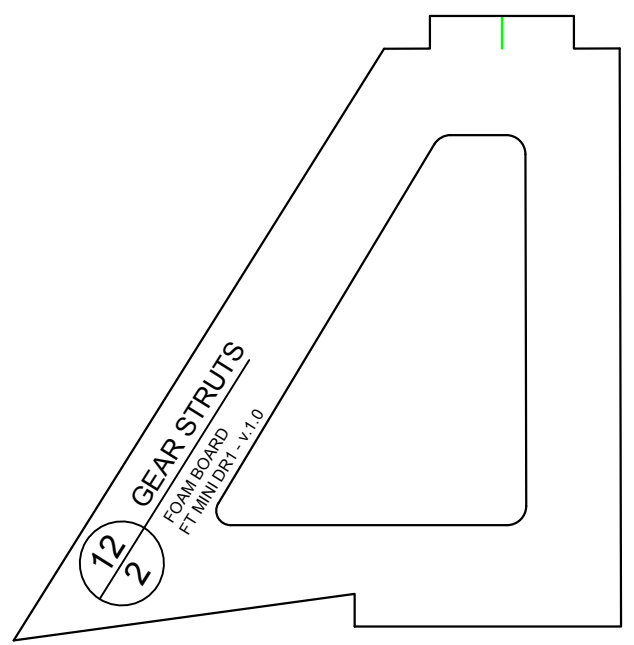

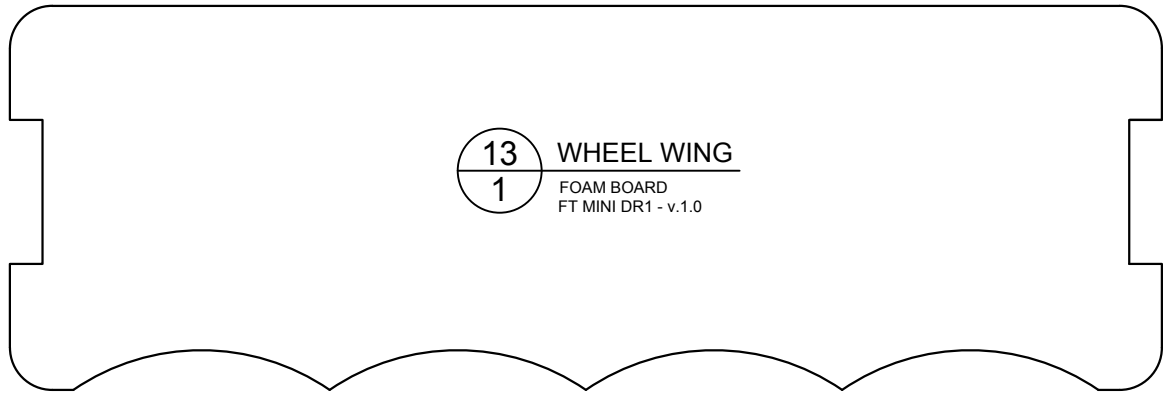

13 WHEEL WING
1 FOAM BOARD
FT MINI DR1 - v.1.0

16 MIDDLE WING
1 FOAM BOARD
FT MINI DR1 - v.1.0

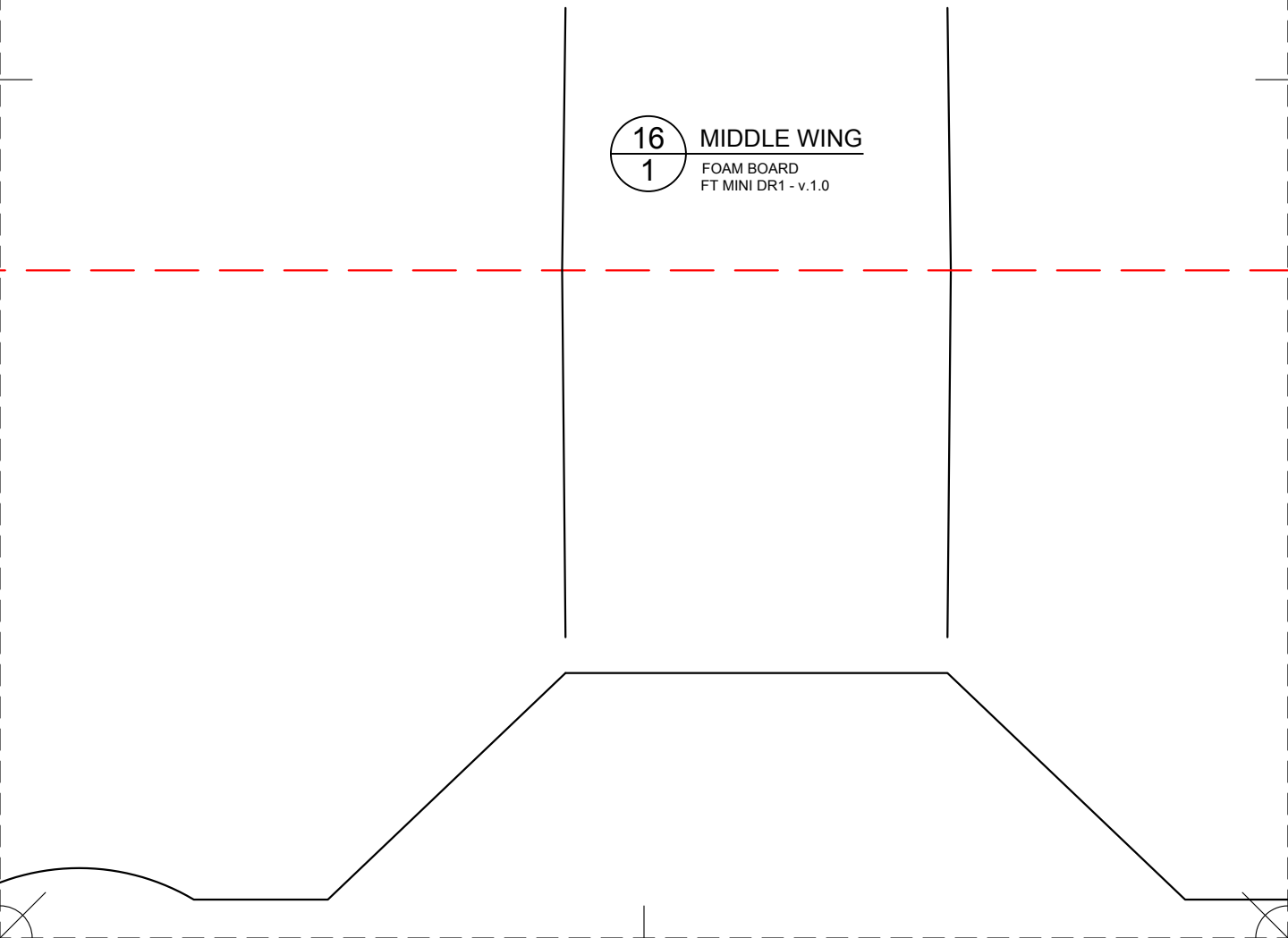

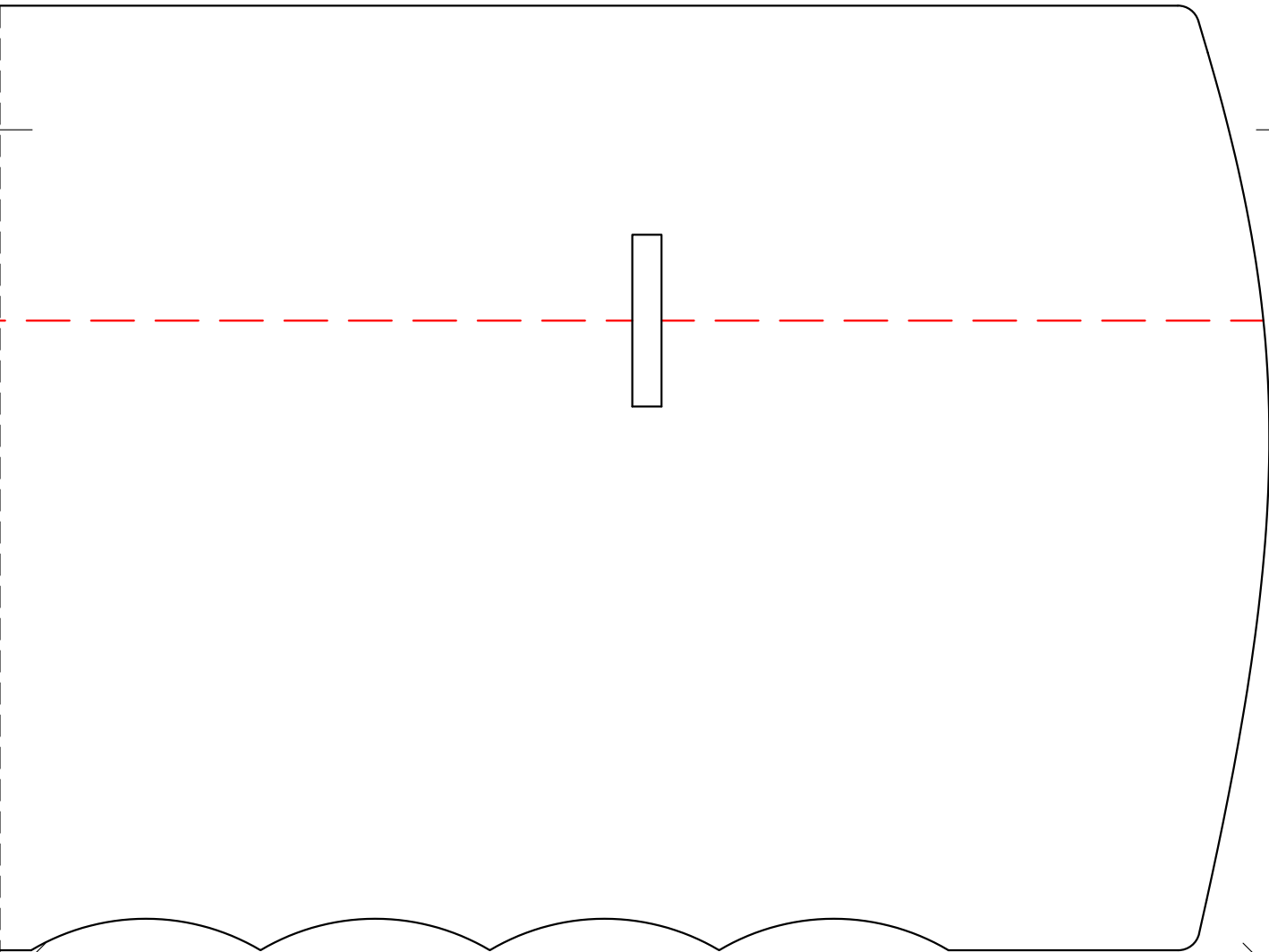
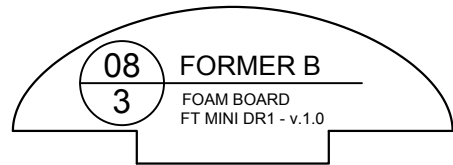
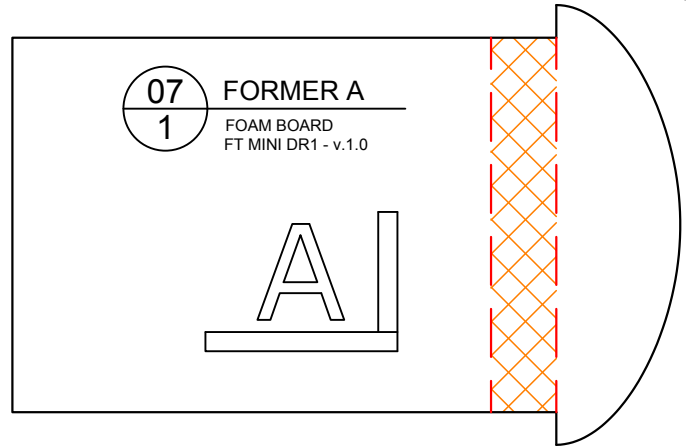
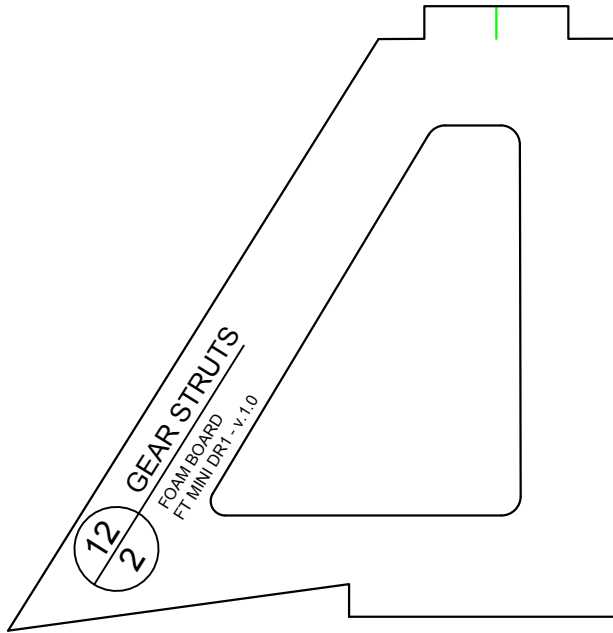

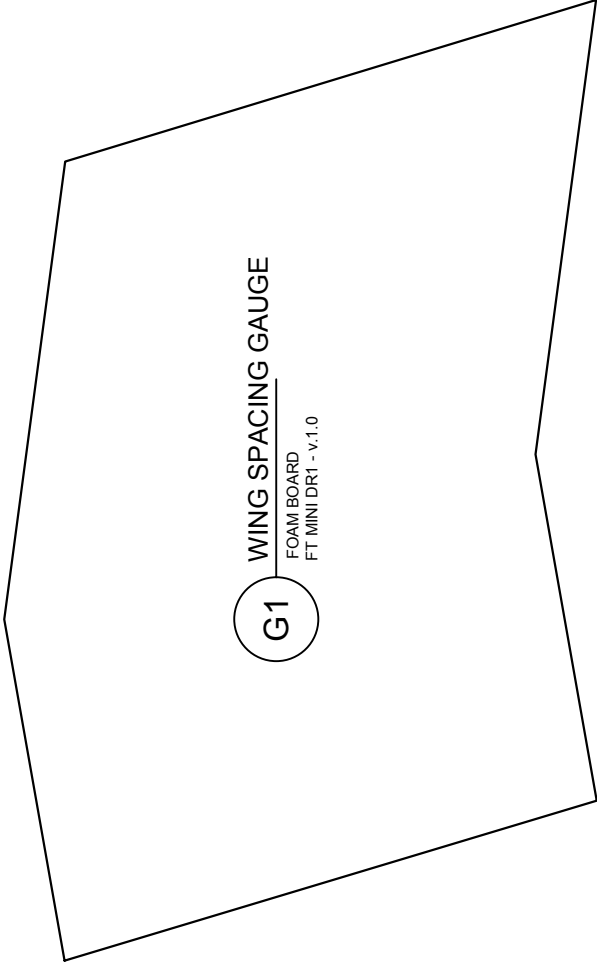
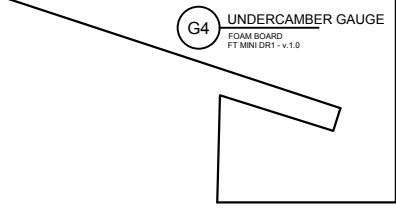
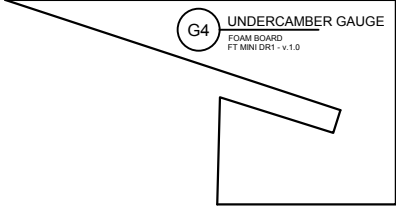
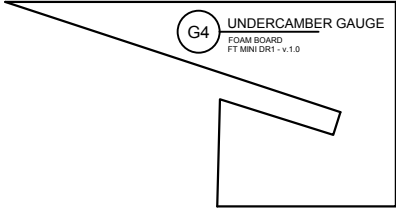
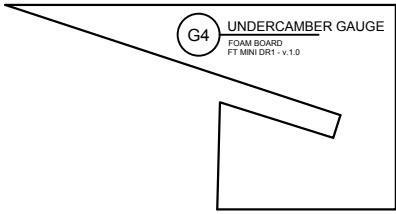
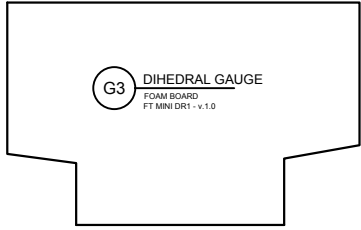
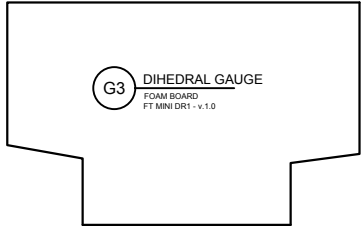
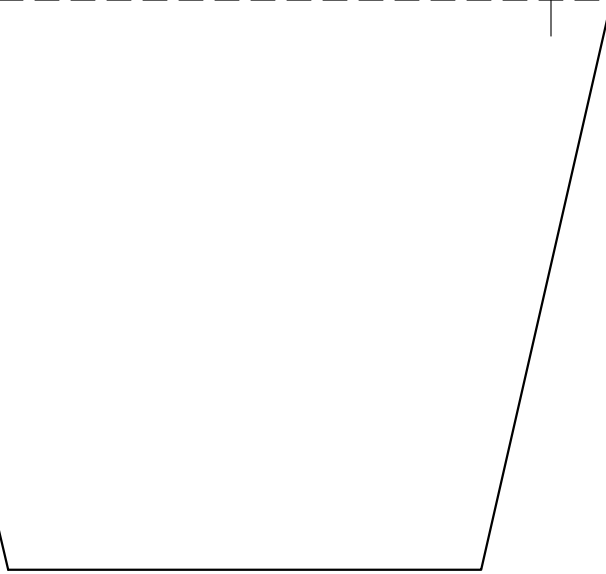

G1

WING SPACING GAUGE

FOAM BOARD
FT MINI DR1 - v.1.0

10
2

CABANE STRUT

FOAM BOARD
FT MINI DR1 - v.1.0

10
2

CABANE STRUT

FOAM BOARD
FT MINI DR1 - v.1.0



CAVITY
OPPOSITE
SIDE

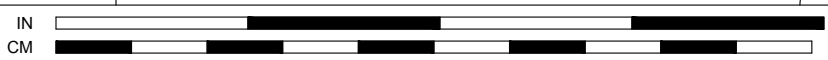

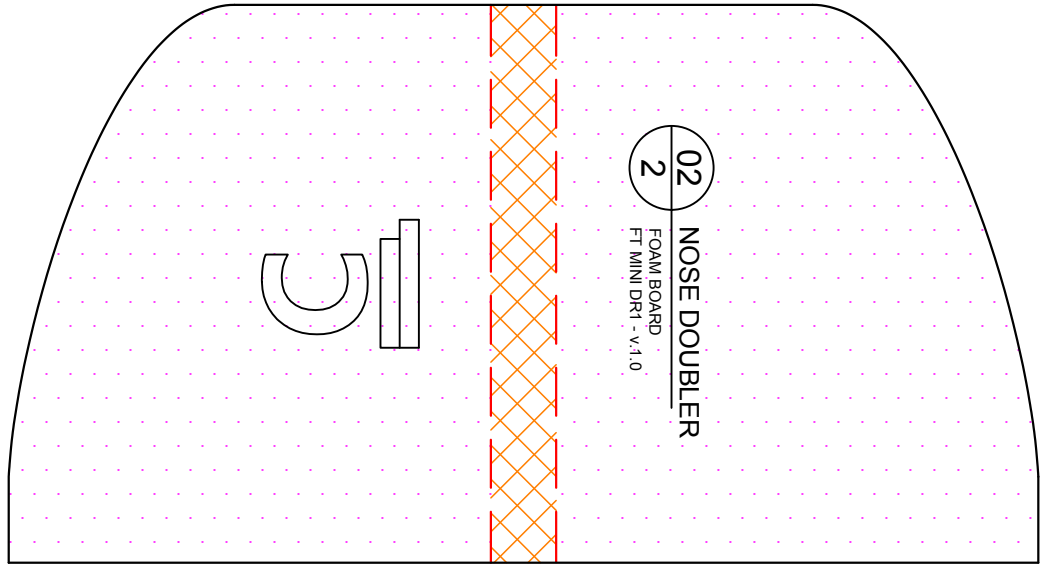
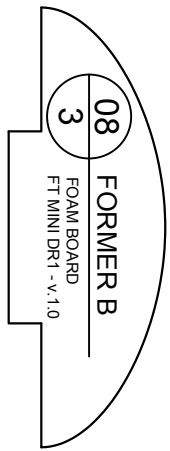

15 BOTTOM WING
FOAM BOARD
FT MINI DR1 - v.1.0

1

