



www.flitetest.com

FT Mini SE5

Designed By: Josh Bixler
 Drawing By: Dan Sponholz



SPECIFICATIONS

DESCRIPTION		IMPERIAL	METRIC
LENGTH		18.75 in	476.0 mm
CENTER OF GRAVITY	CG	2.0 in	50.8 mm
WING SPAN		24.0 in	609.6 mm
WING AREA		264.2 in ²	17.0 dm ²
DRY WEIGHT		8.8 oz	249.5 g
ALL UP WEIGHT	AUW	11.5 oz	326.0 g
WING LOADING	WL	6.3 oz/ft ²	19.2 g/dm ²
WING CUBIC LOADING	WCL	4.6	

RECOMMENDED SETTINGS

	THROW	EXPO
ELEVATOR	12°	30%
RUDDER	12°	30%



Build Skill Level :



Pilot Skill Level :



SHEET & TILE KEY

1	2	3	4
5	6	7	8

9	10	11	12
13	14	15	16



DRAWING KEY

FOLD TYPES

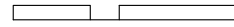
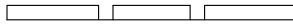
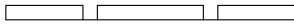
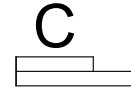
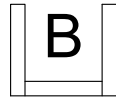
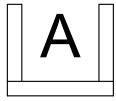

A - FOLD (ABOVE)

B - FOLD (BESIDE)

C - FOLD (COVER)

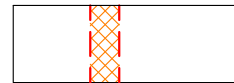
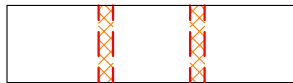
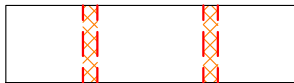

LINE TYPE/COLOR

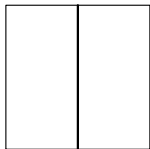

CUT

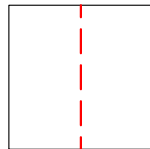

50% SCORE

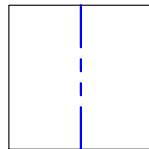
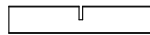

CREASE

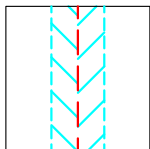
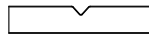

45° DOUBLE BEVEL

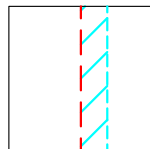

45° SINGLE BEVEL

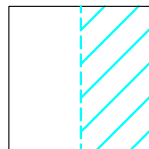

EDGE BEVEL

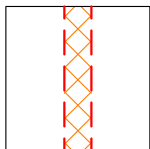

CAVITY

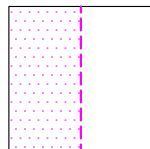

REMOVE PAPER

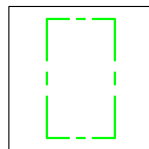
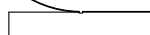

REFERENCE/
OPTIONAL

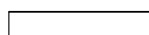

SYMBOLS

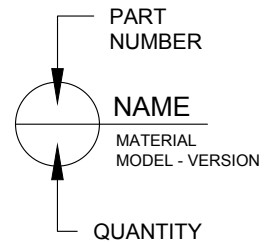

DOWEL HOLE



CENTER OF GRAVITY (CG)

FT Mini SE5

Designed By: Josh Bixler
Drawing By: Dan Sponholz

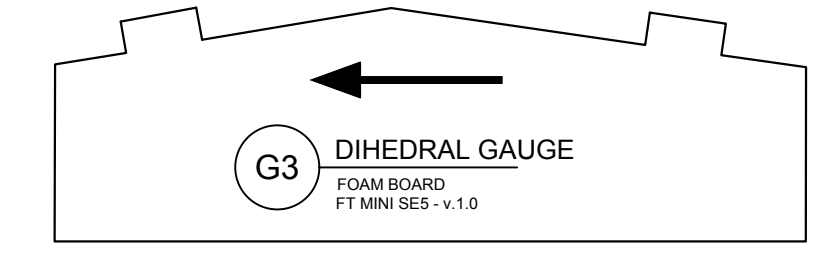
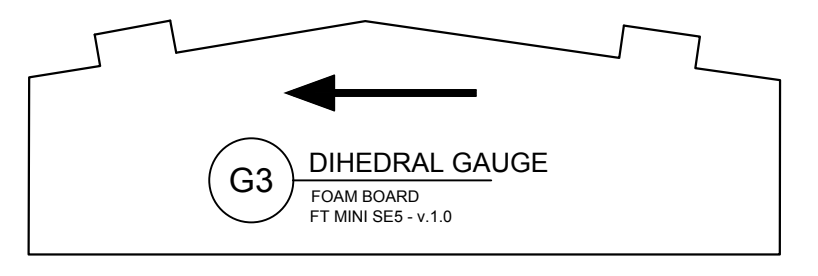
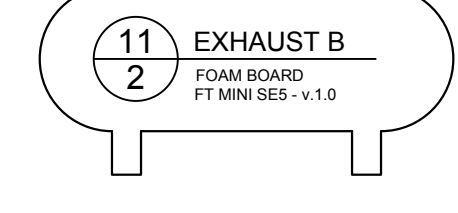
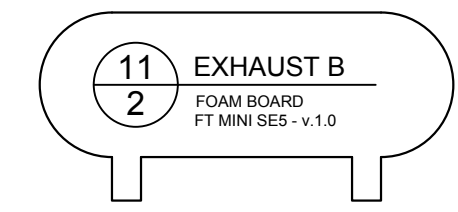
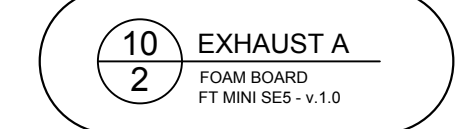
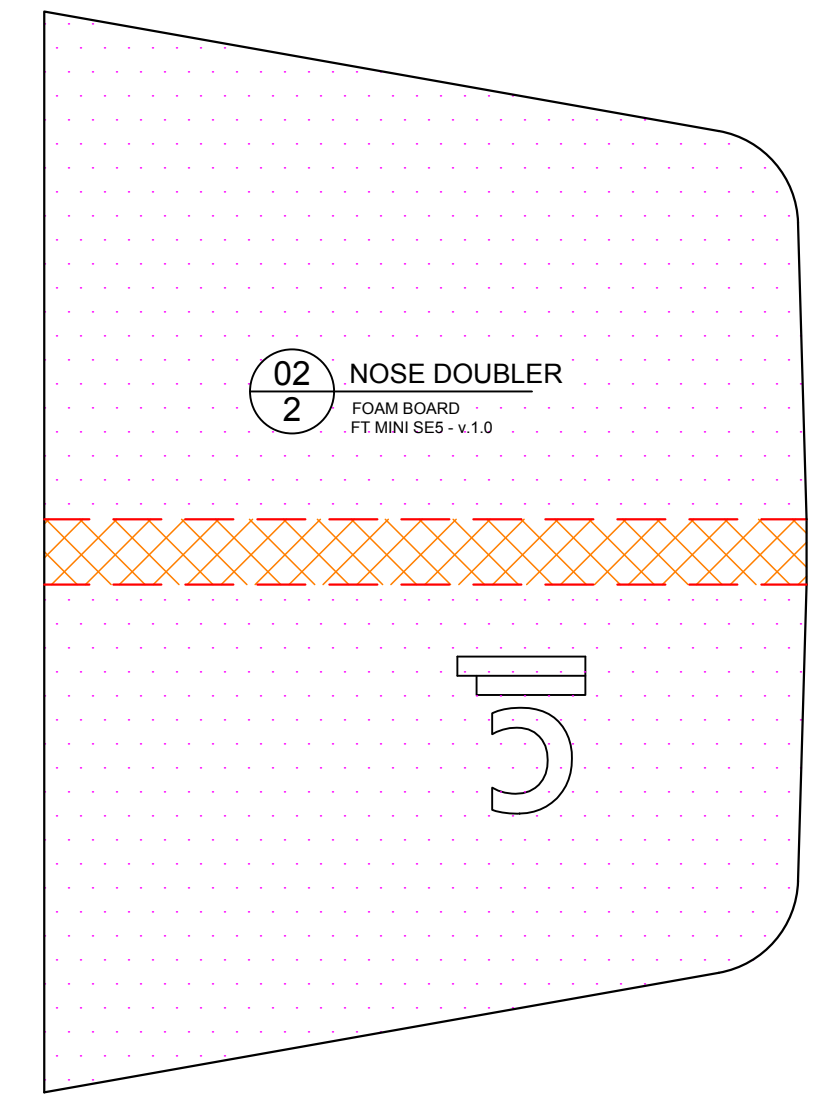
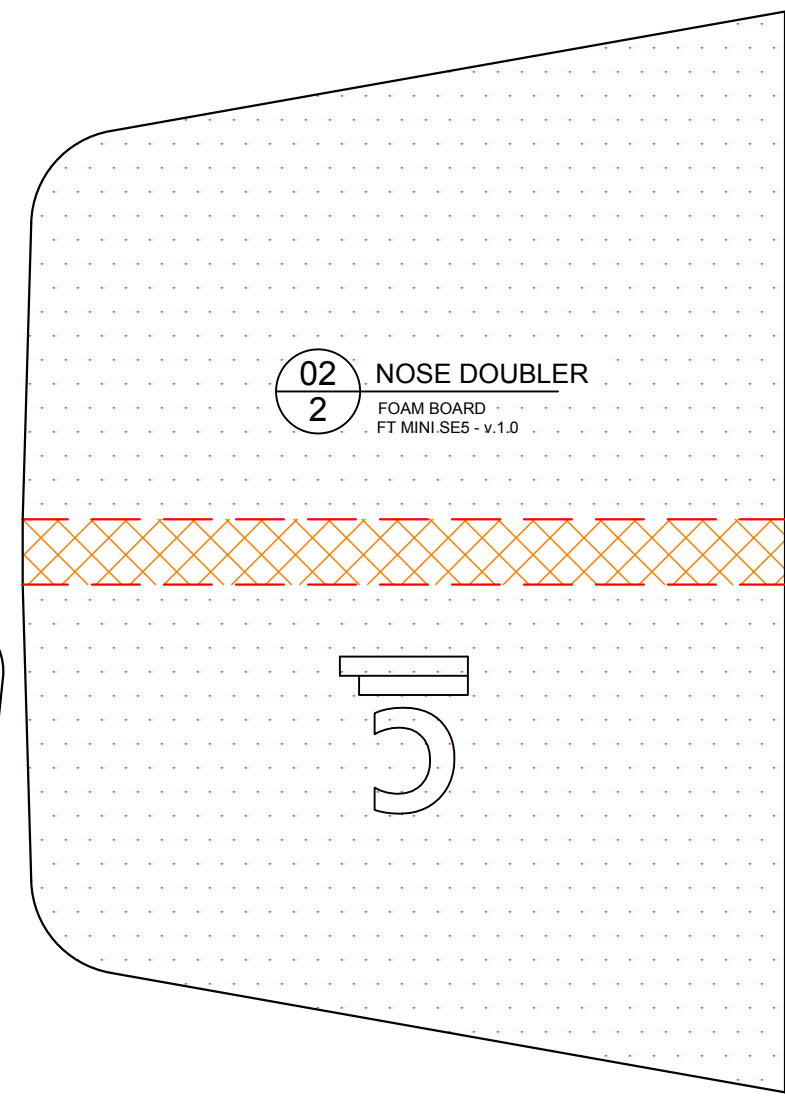
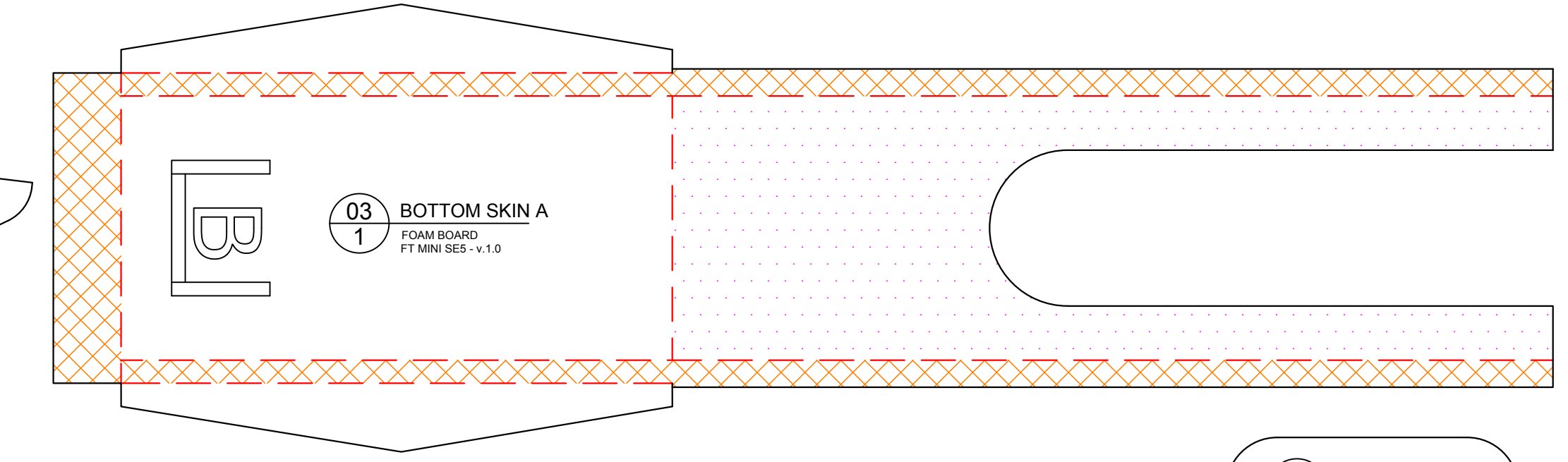
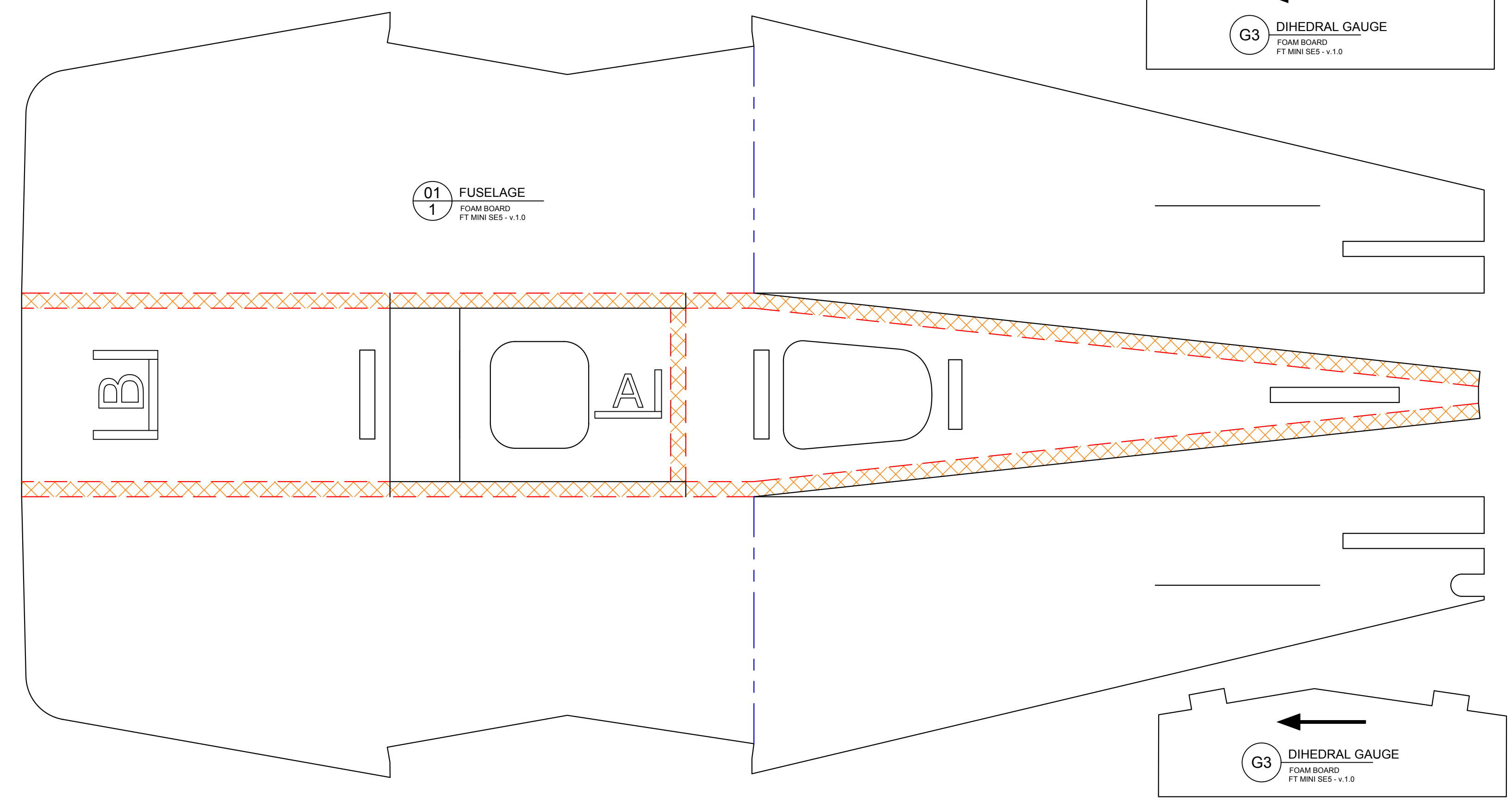
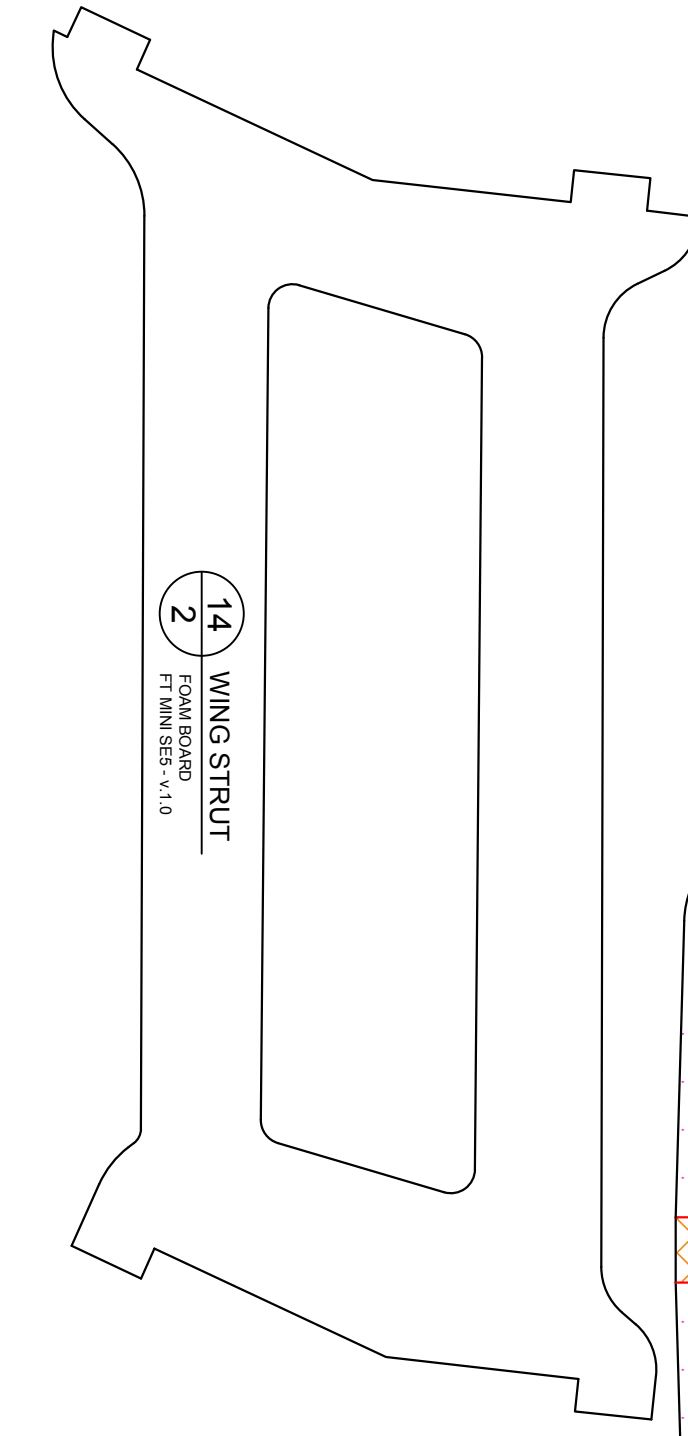
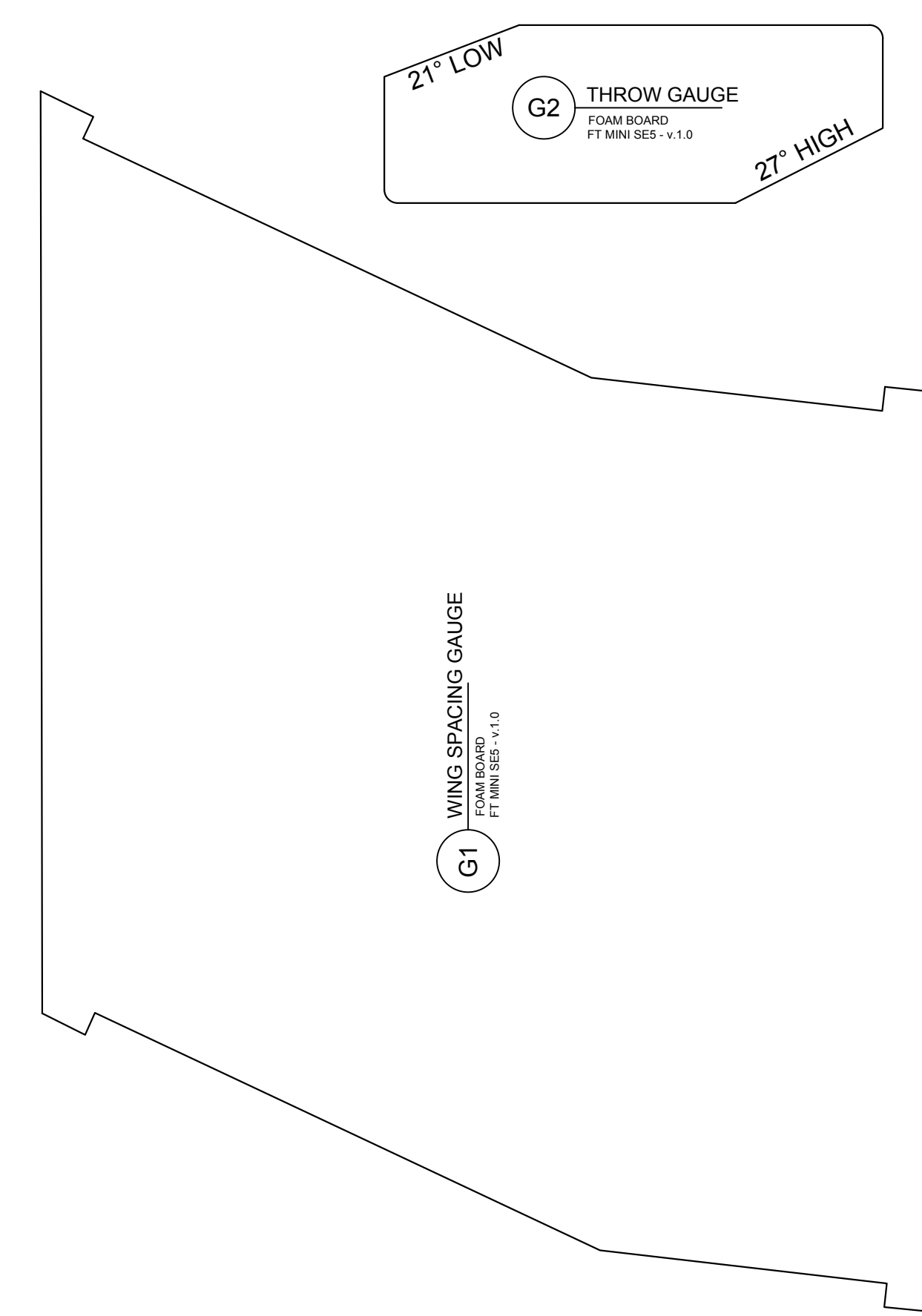
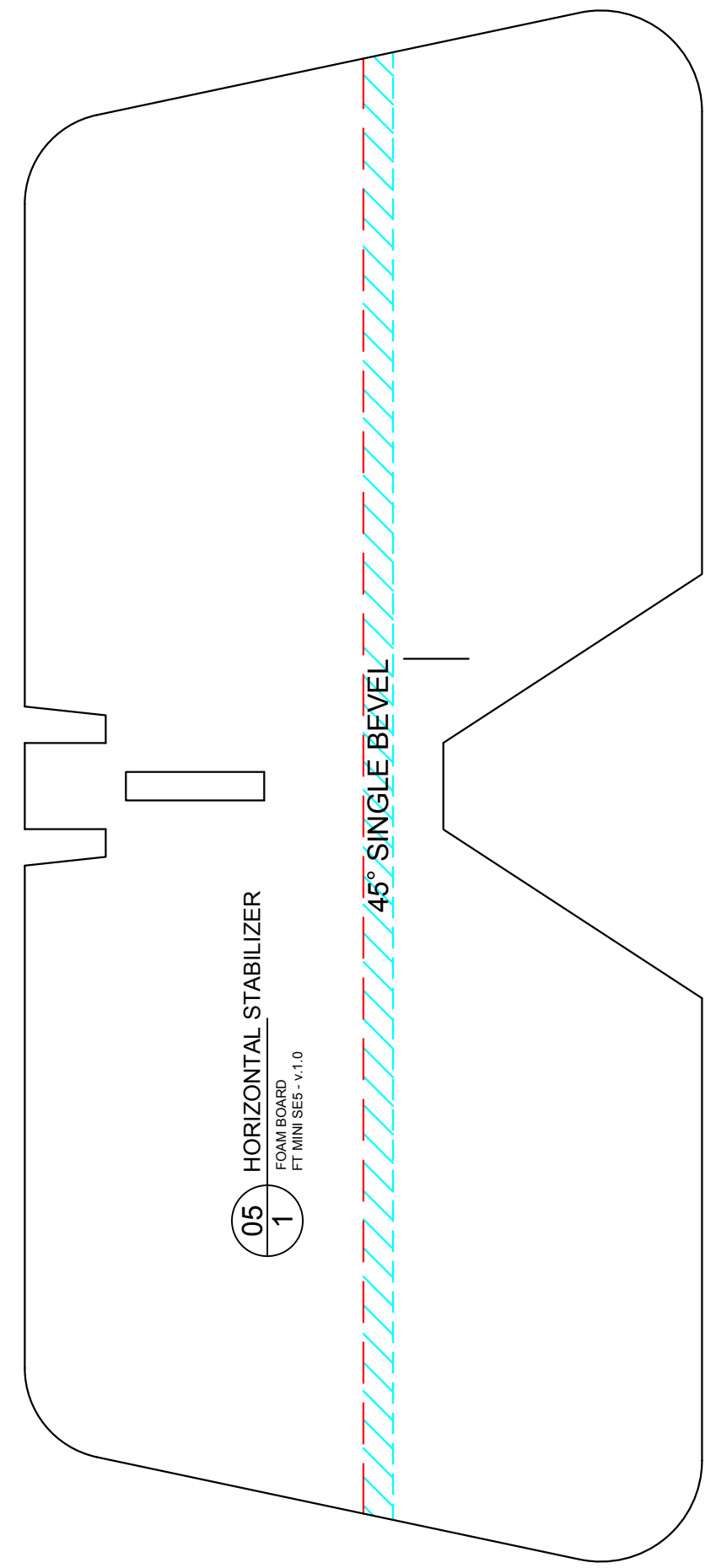
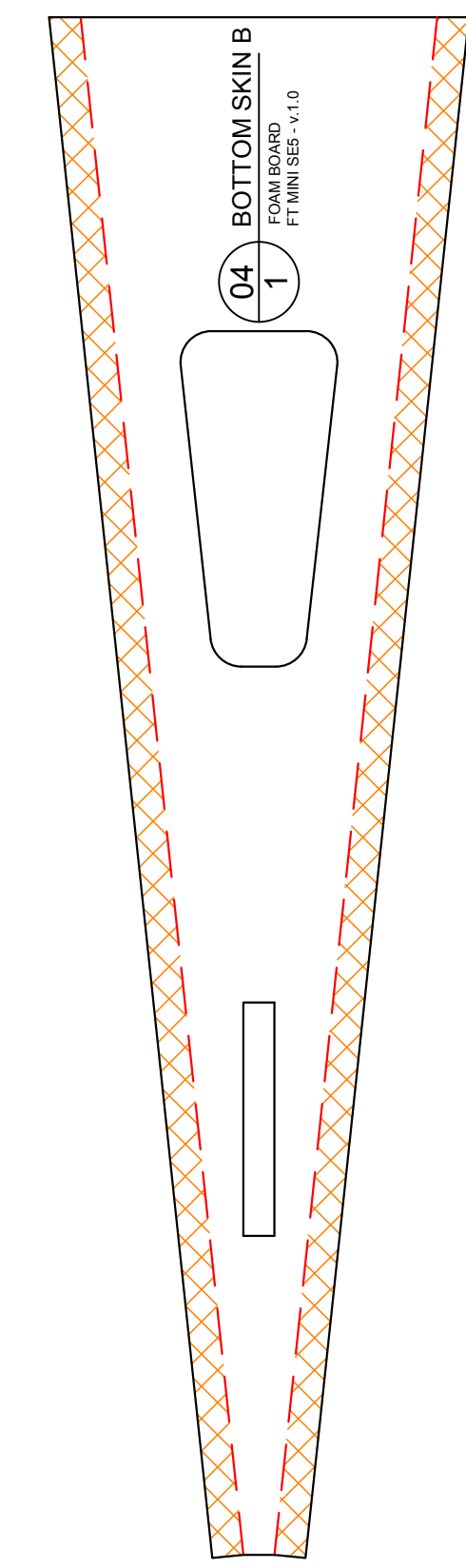
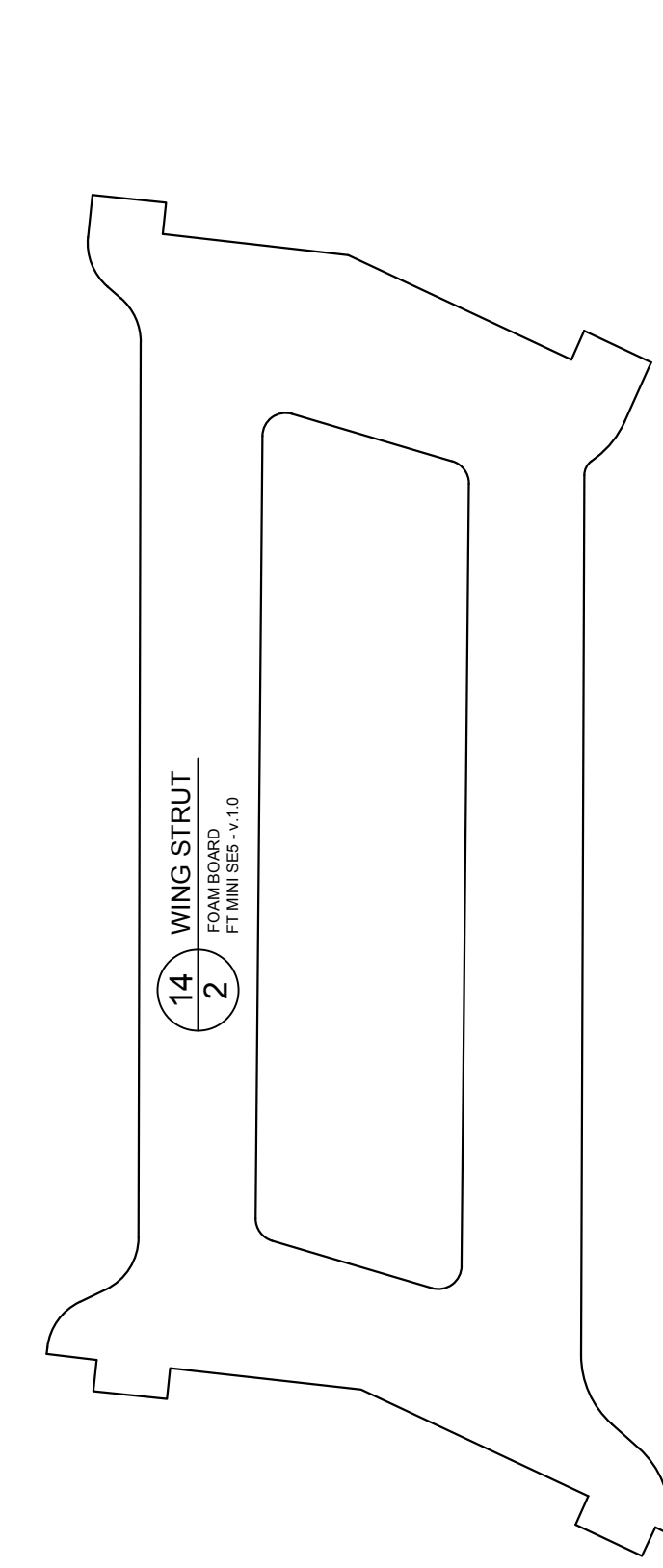
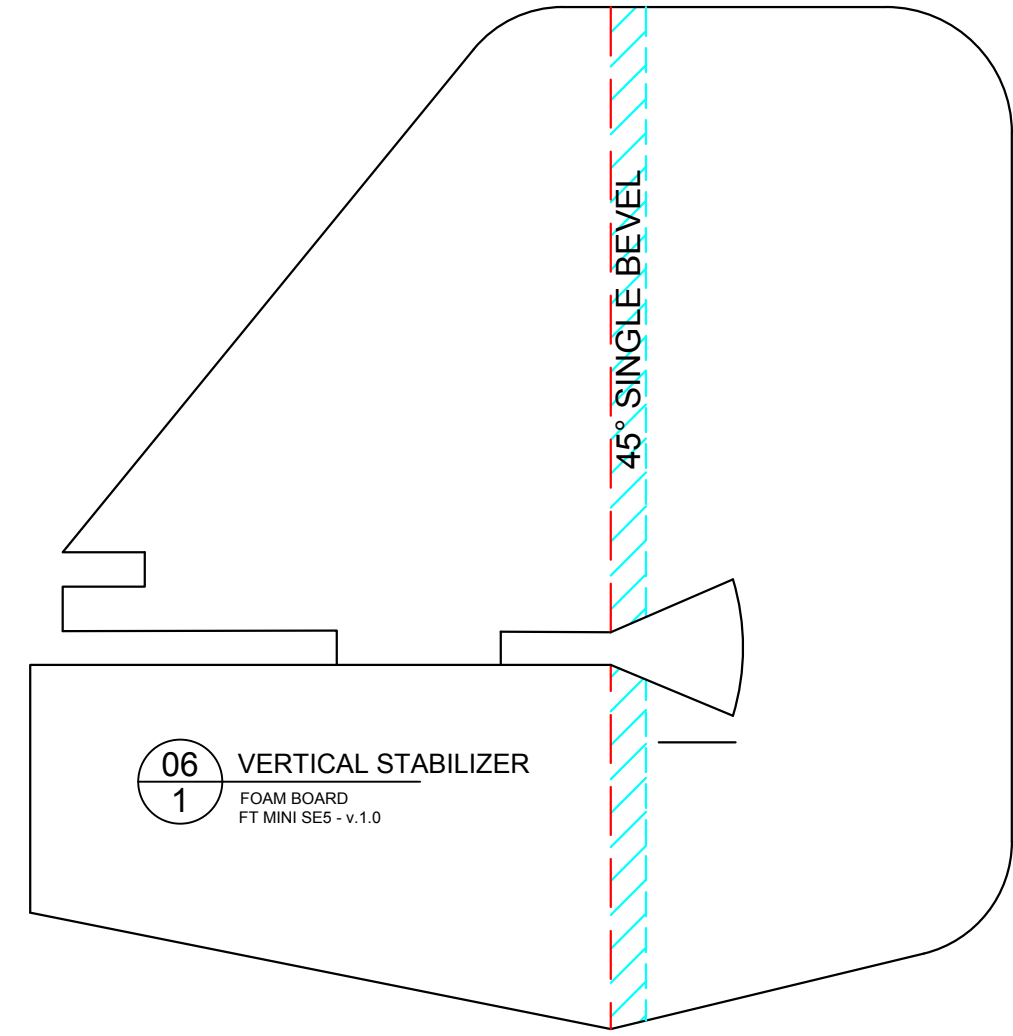
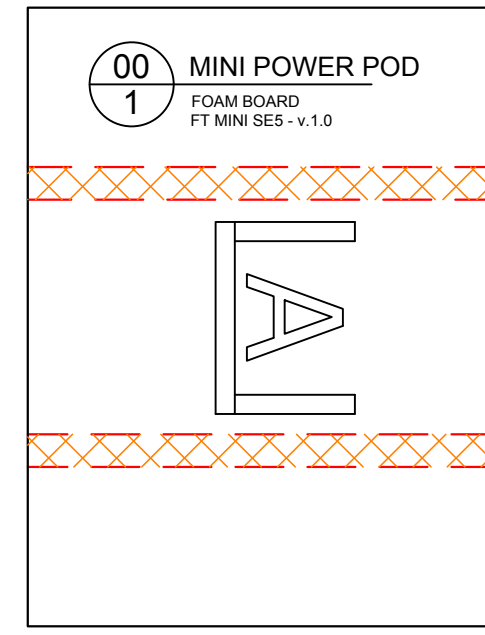

FT Mini SE5

Designed By: Josh Bixler
Drawing By: Dan Sponholz

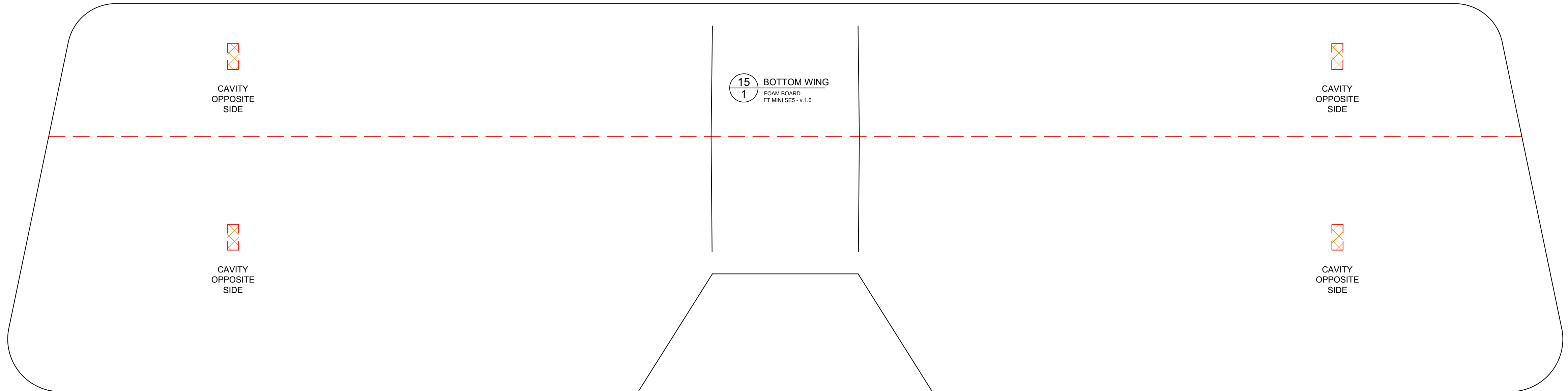
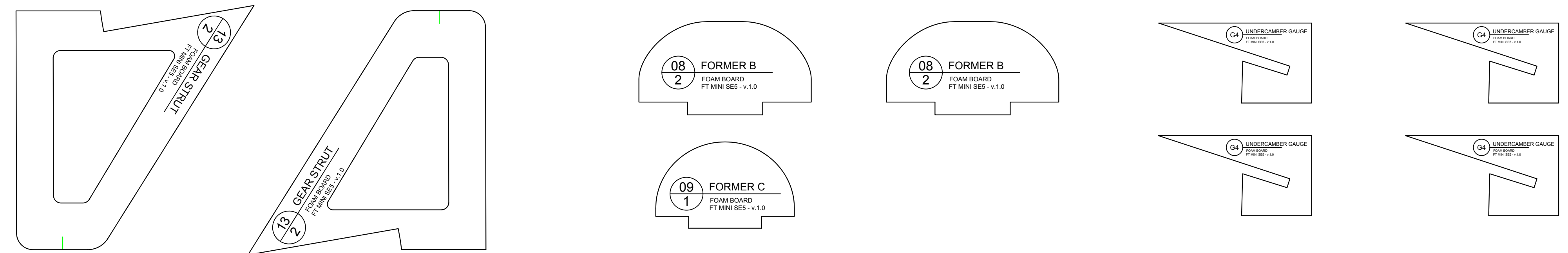
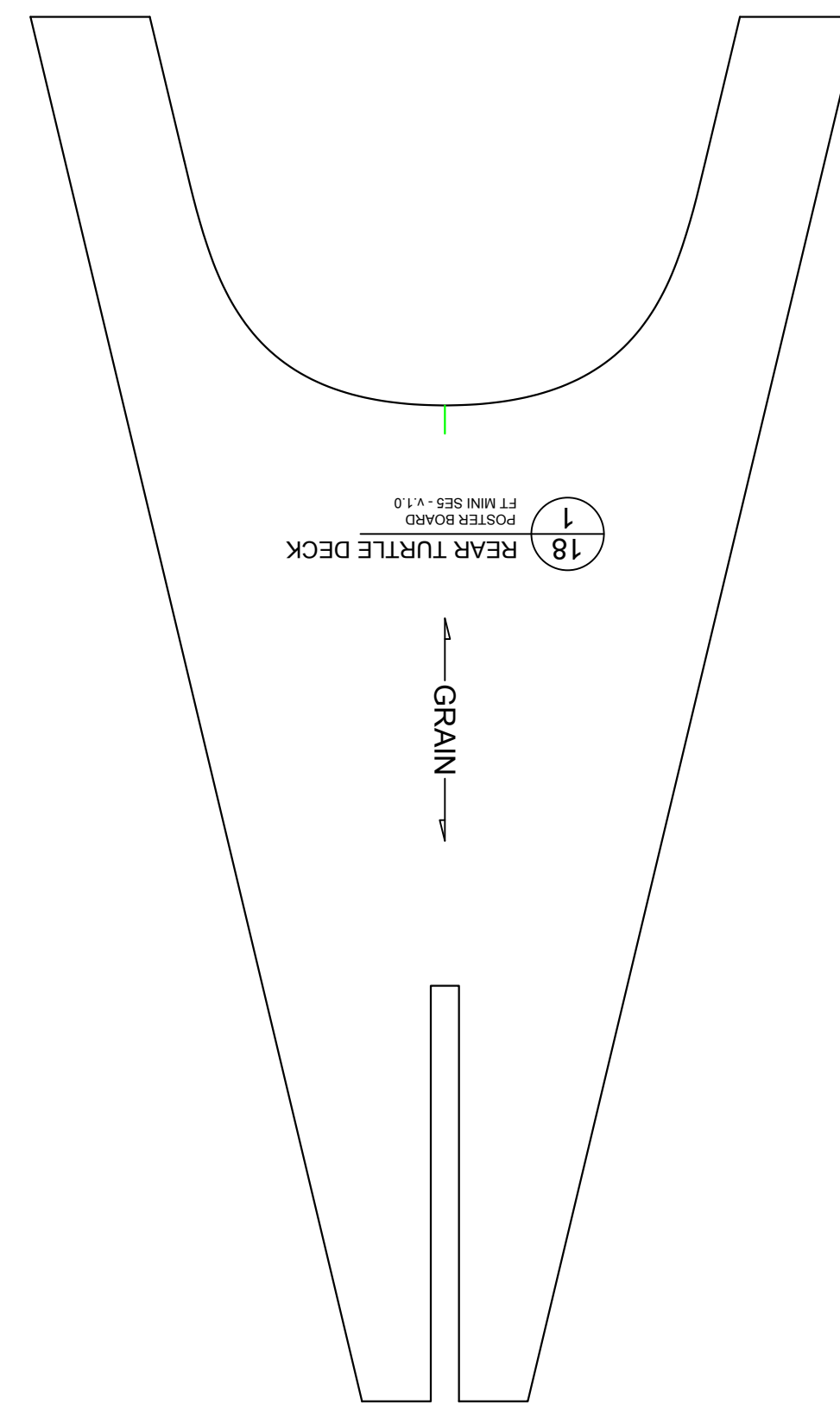
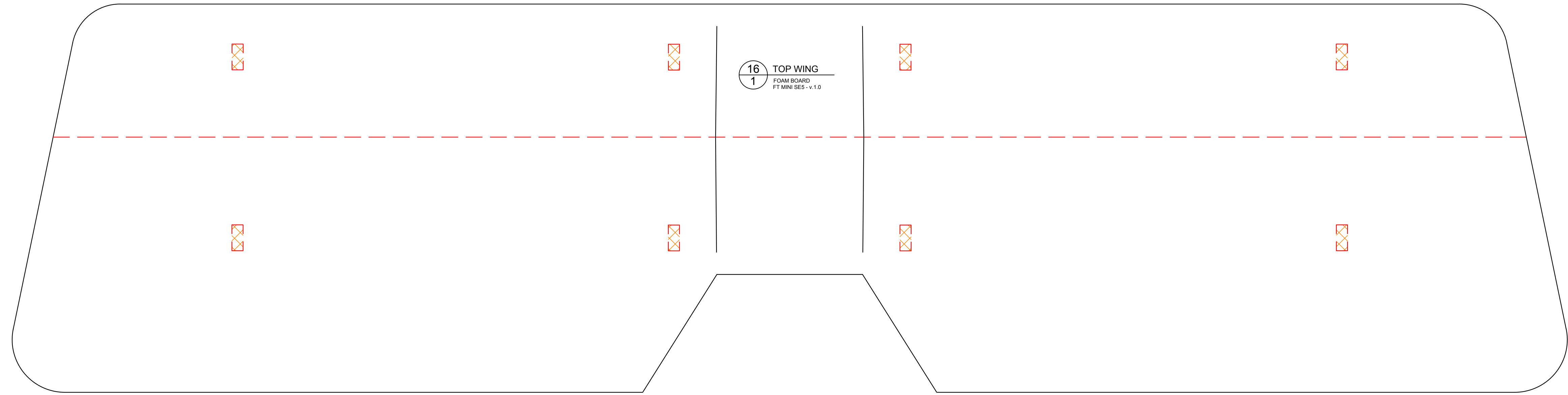
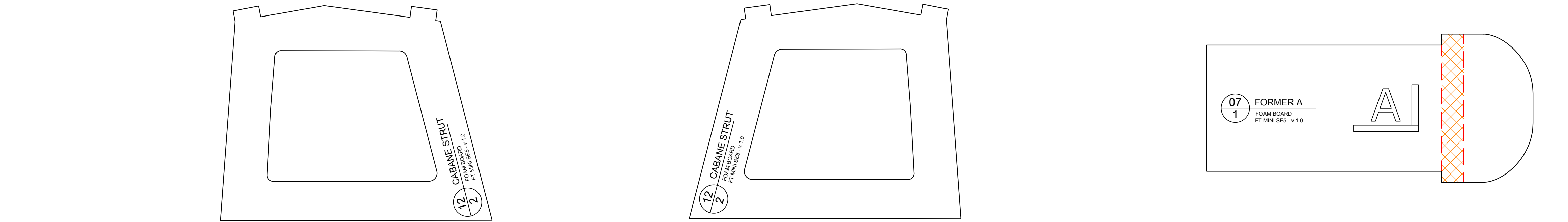
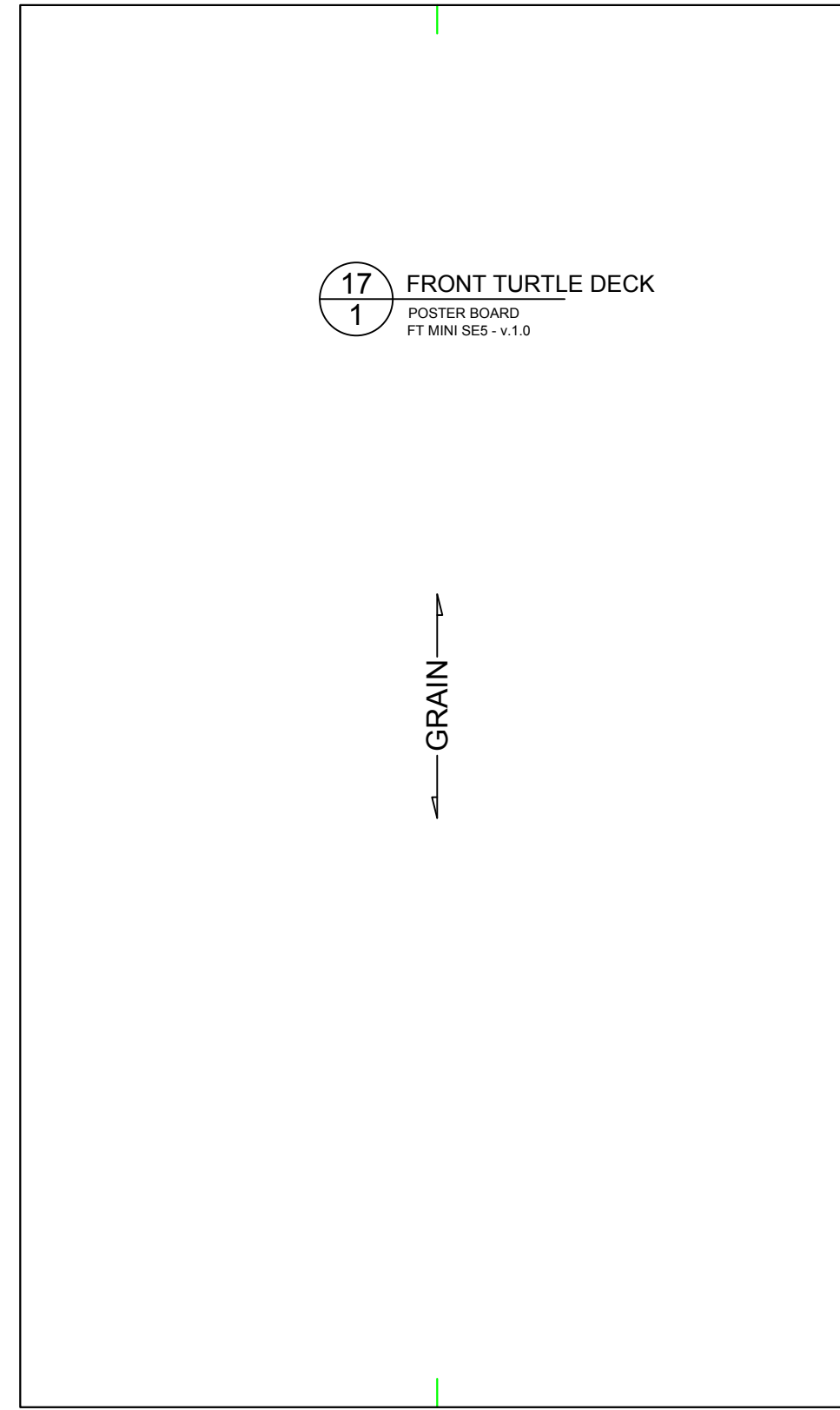

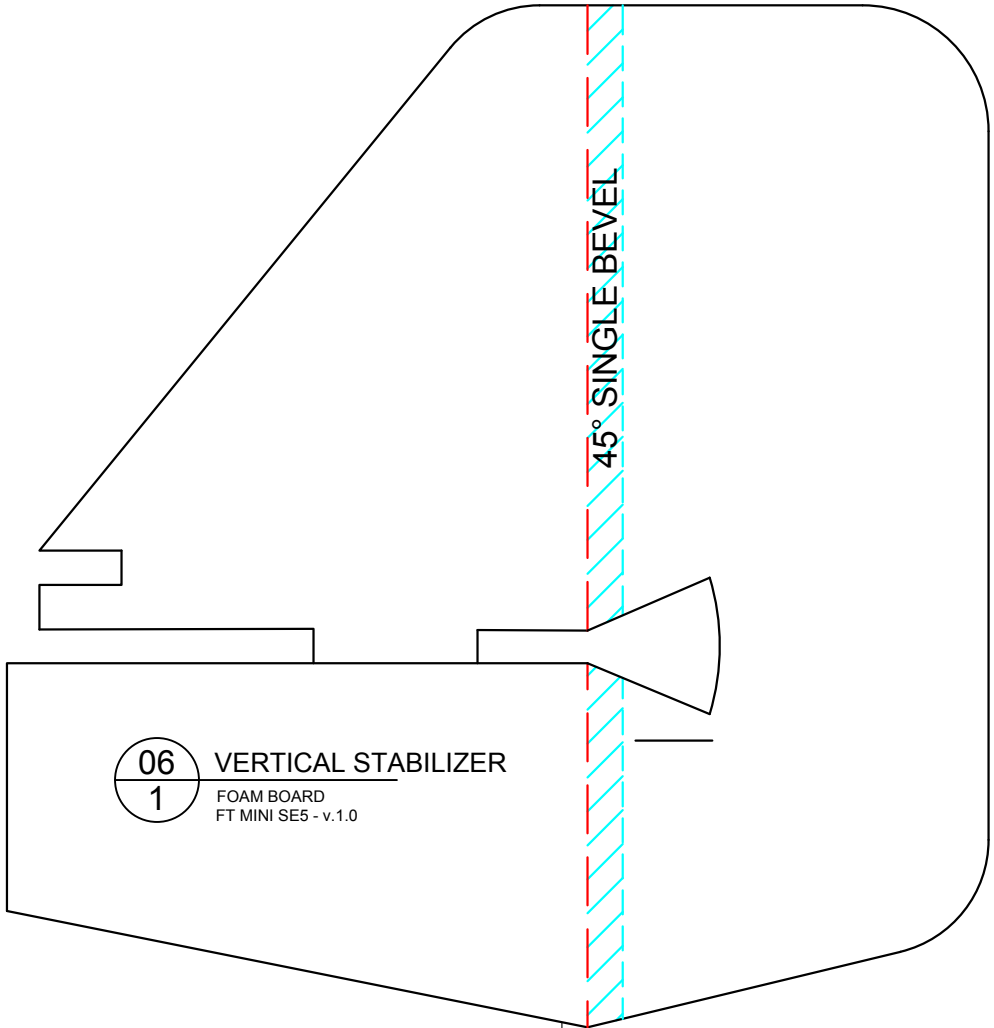
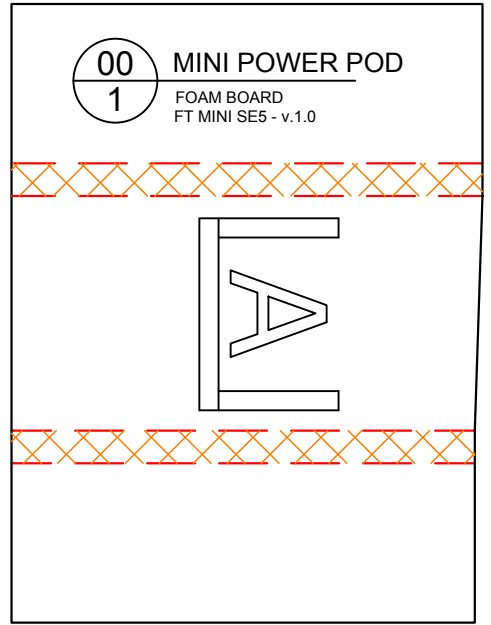

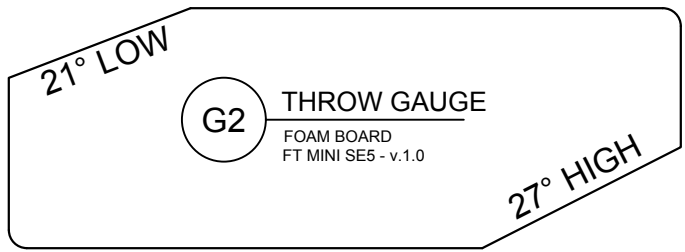
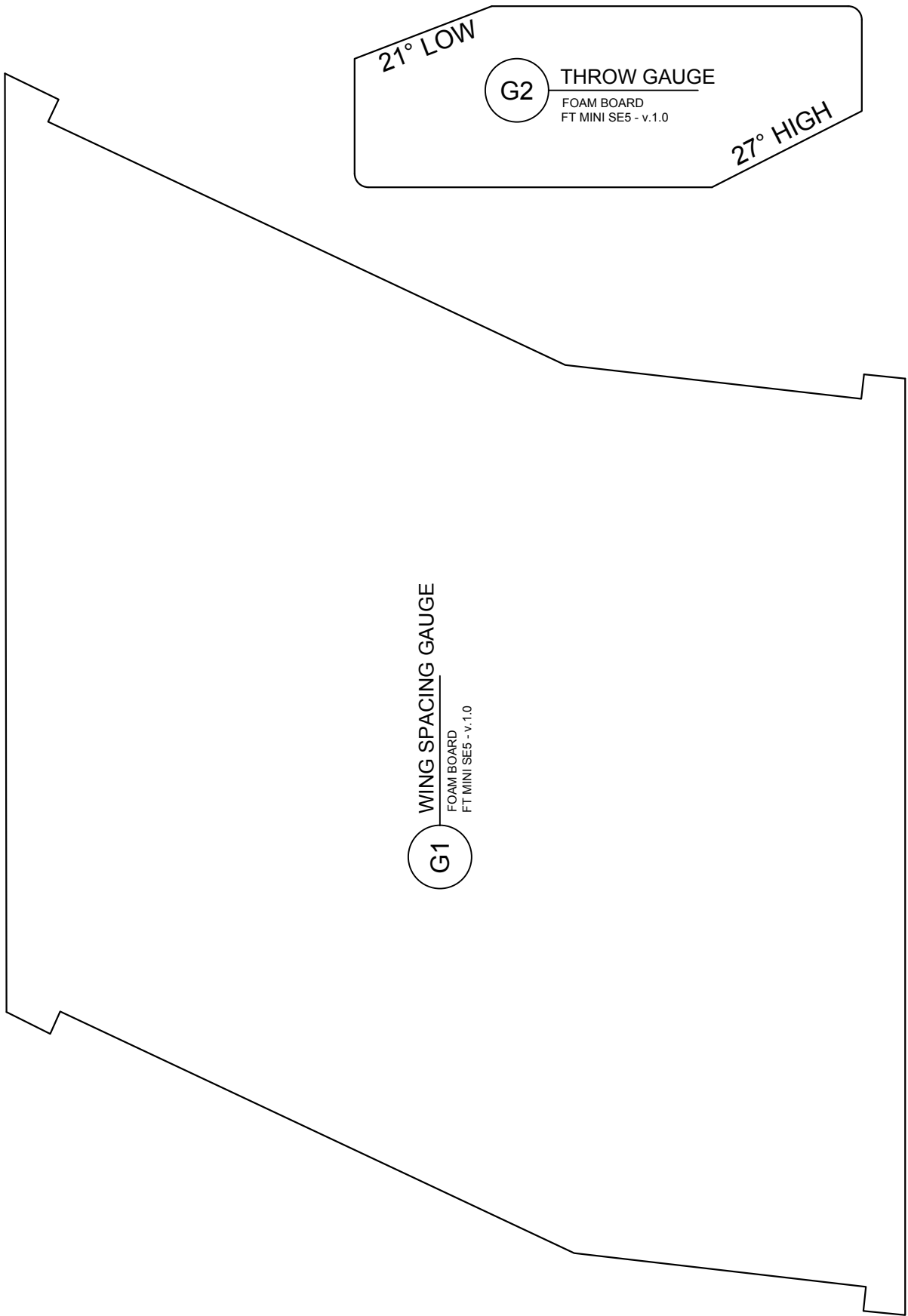

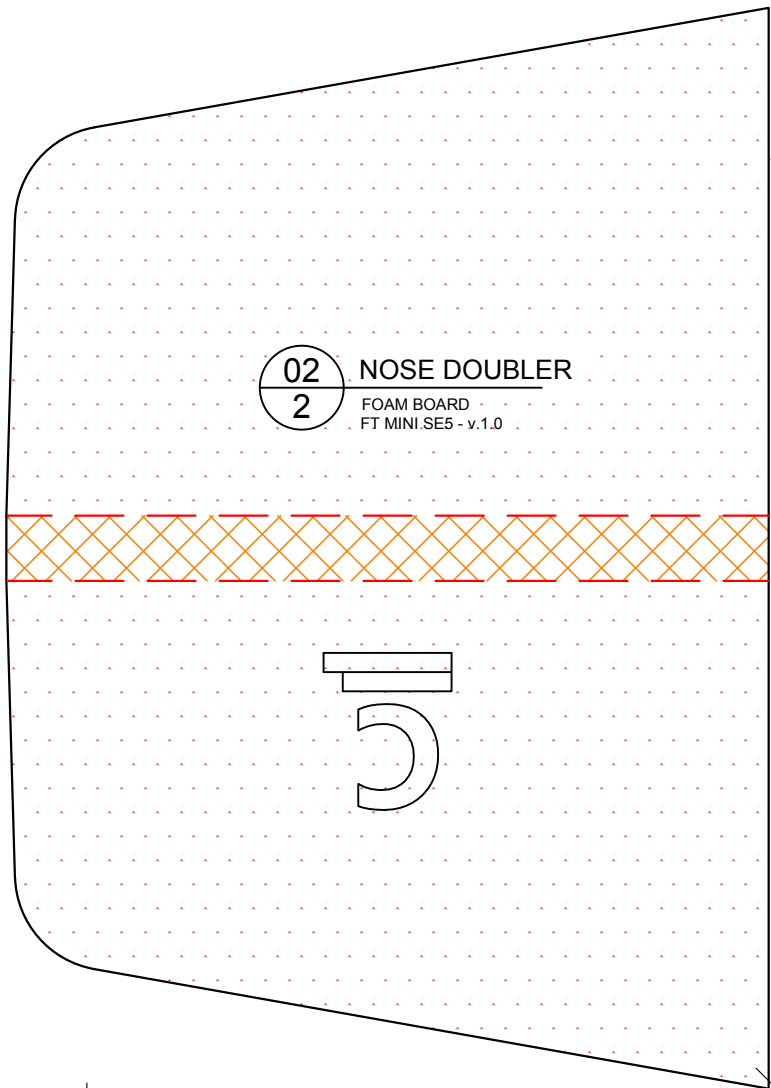
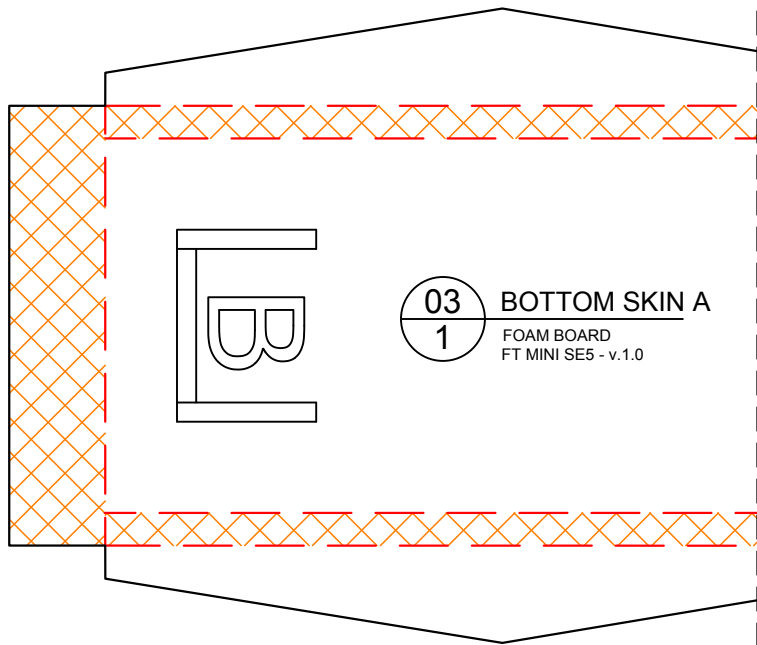
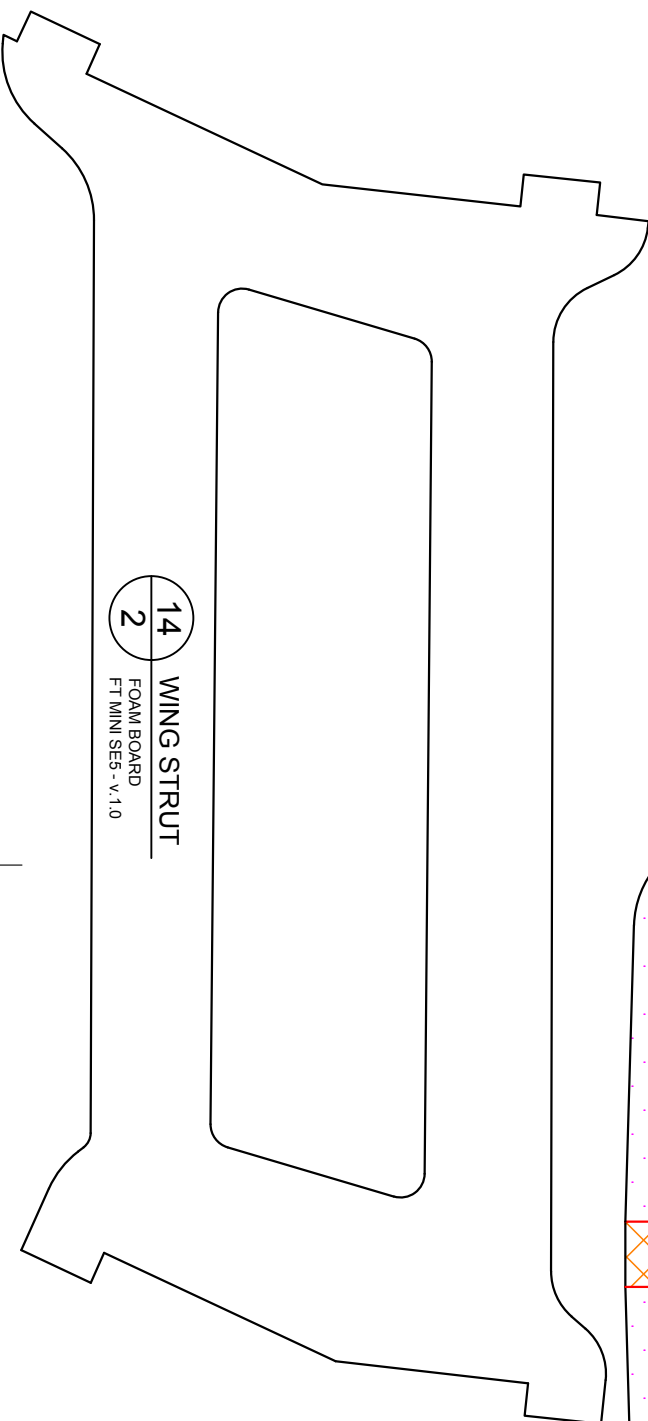

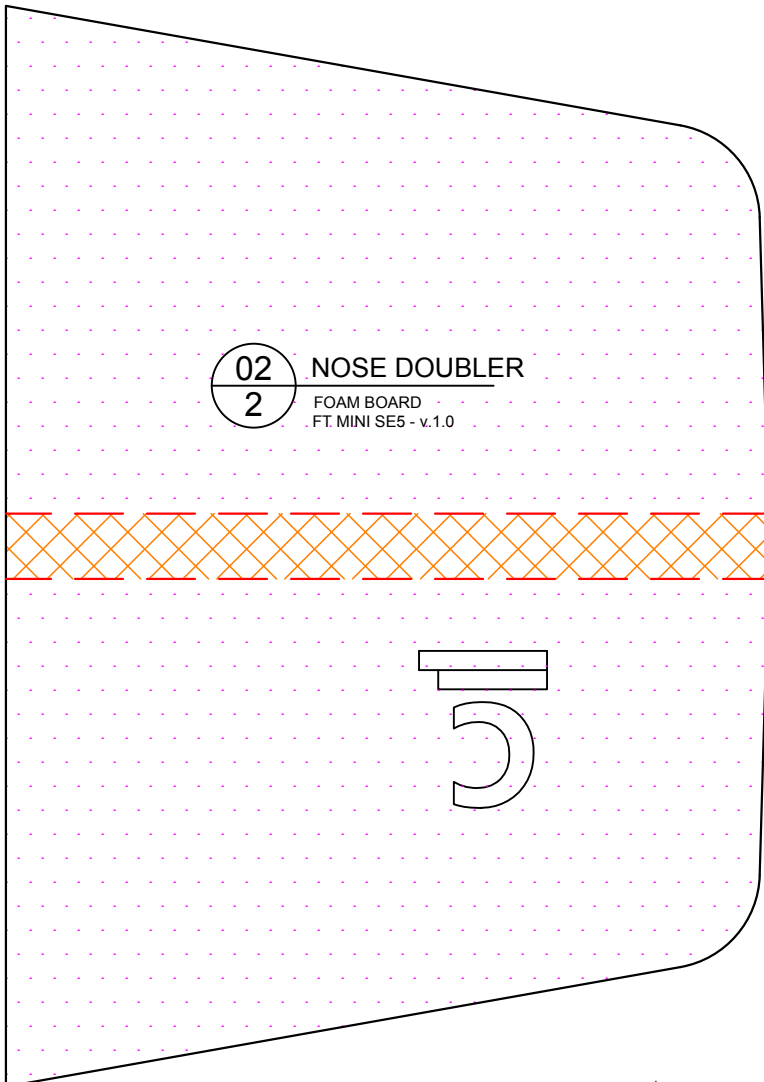
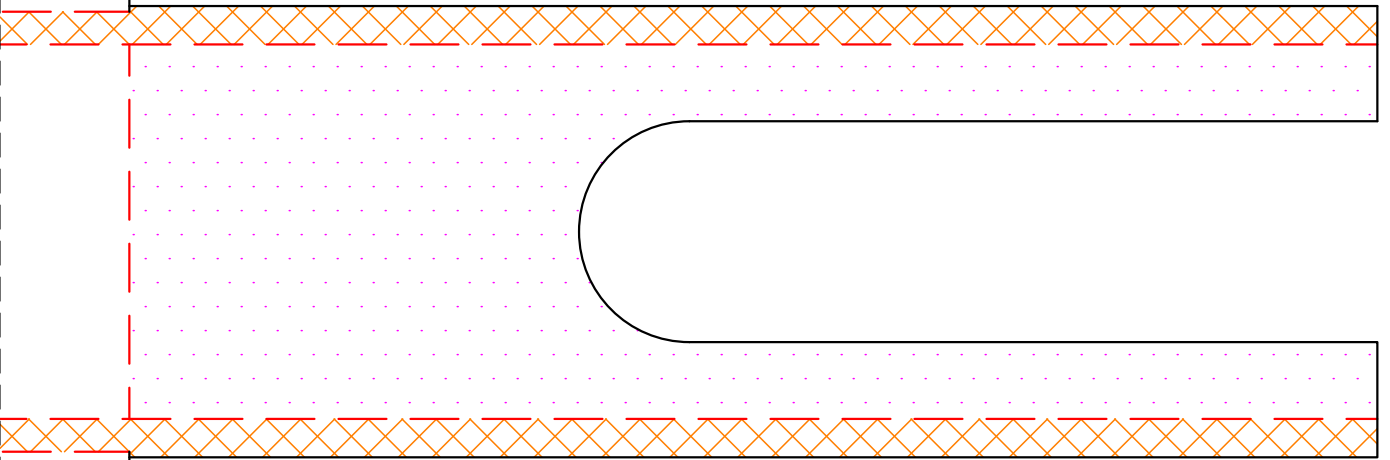

02
2 NOSE DOUBLER
FOAM BOARD
FT MINI SE5 - v.1.0

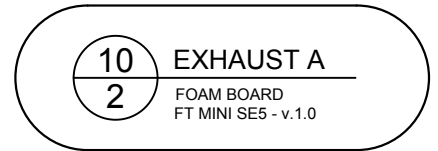

10
2 EXHAUST A
FOAM BOARD
FT MINI SE5 - v.1.0

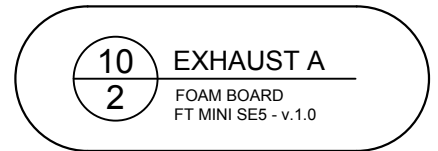

10
2 EXHAUST A
FOAM BOARD
FT MINI SE5 - v.1.0

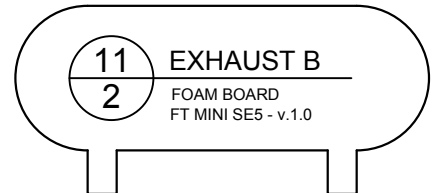

11
2 EXHAUST B
FOAM BOARD
FT MINI SE5 - v.1.0

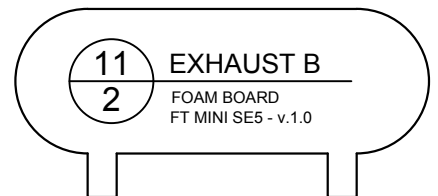

11
2 EXHAUST B
FOAM BOARD
FT MINI SE5 - v.1.0

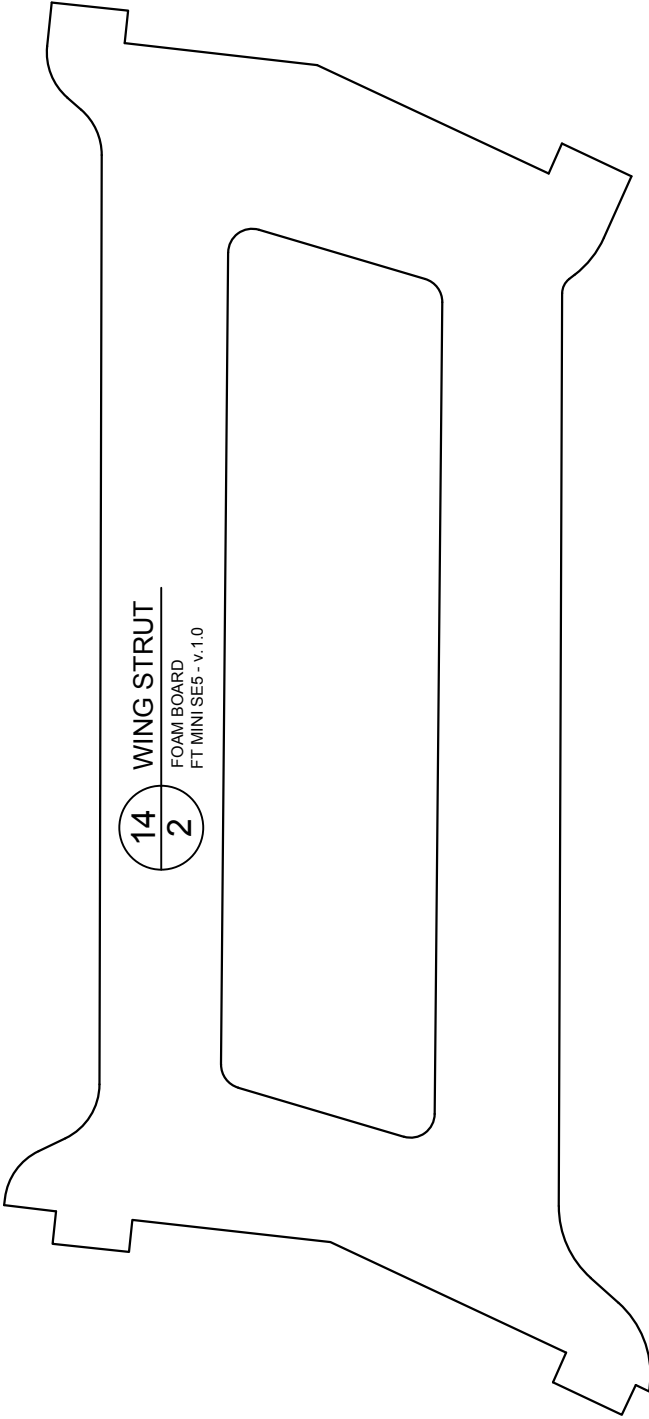

14 WING STRUT
FOAM BOARD
FT MINI SE5 - v.1.0
2

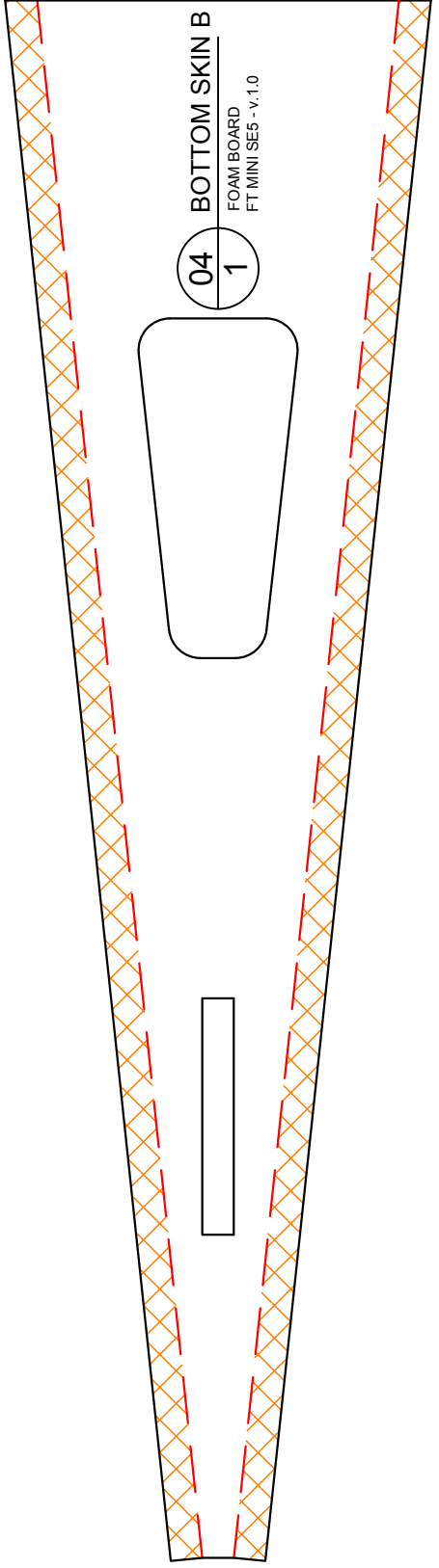

04 BOTTOM SKIN B
FOAM BOARD
FT MINI SE5 - v.1.0
1



05
1

HORIZONTAL STABILIZER

FOAM BOARD
FT MINI SE5 - v.1.0

45° SINGLE BEVEL

B

01 FUSELAGE
1 FOAM BOARD
FT MINI SE5 - v.1.0

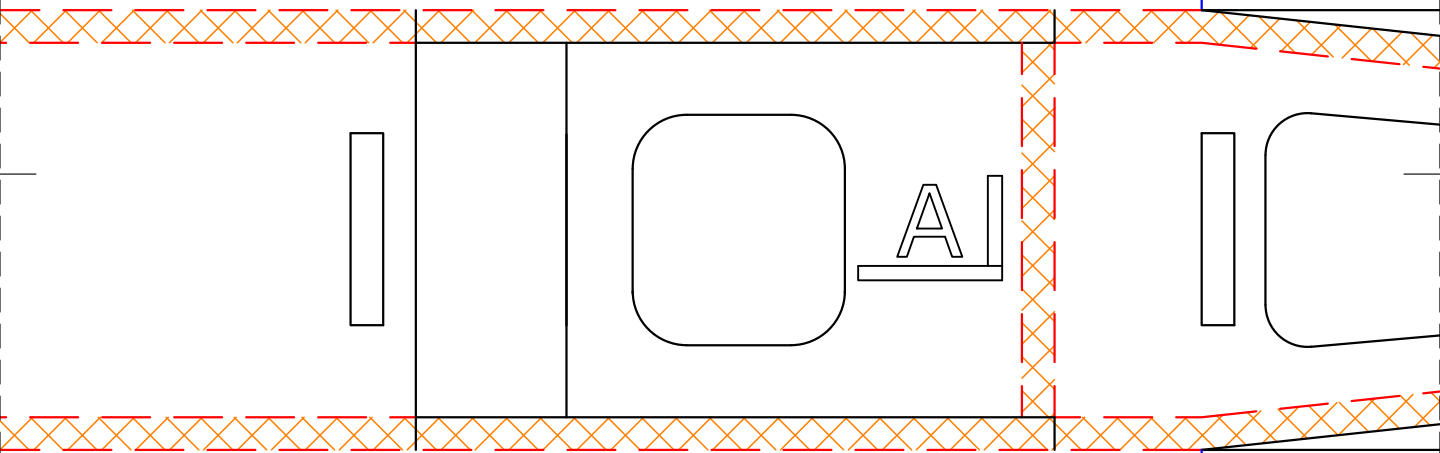

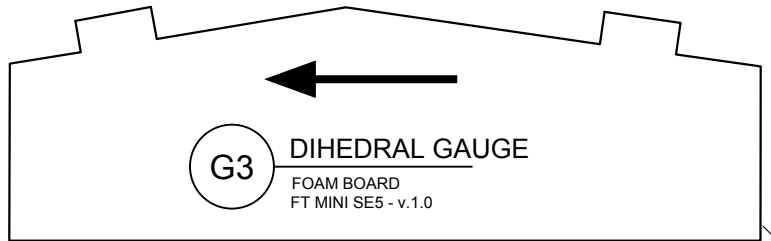
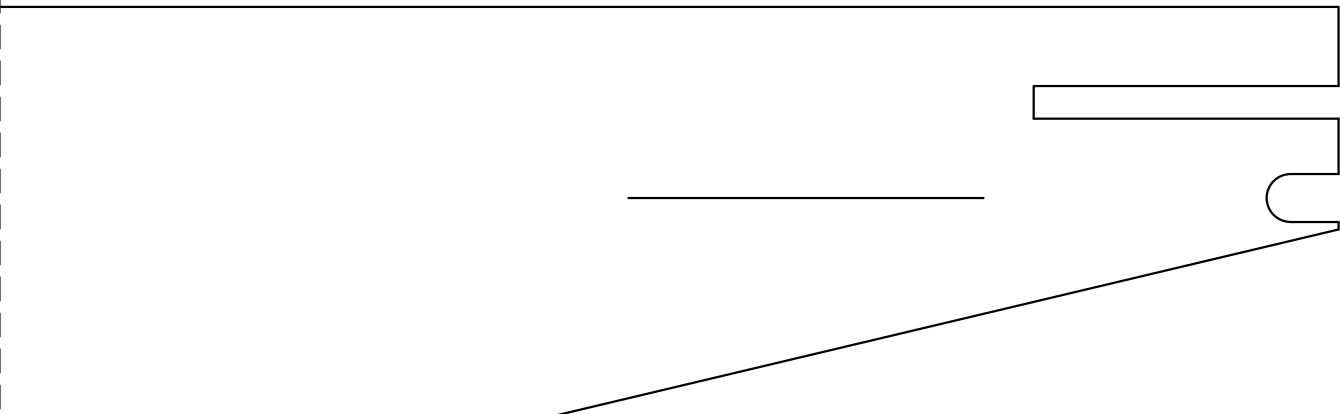
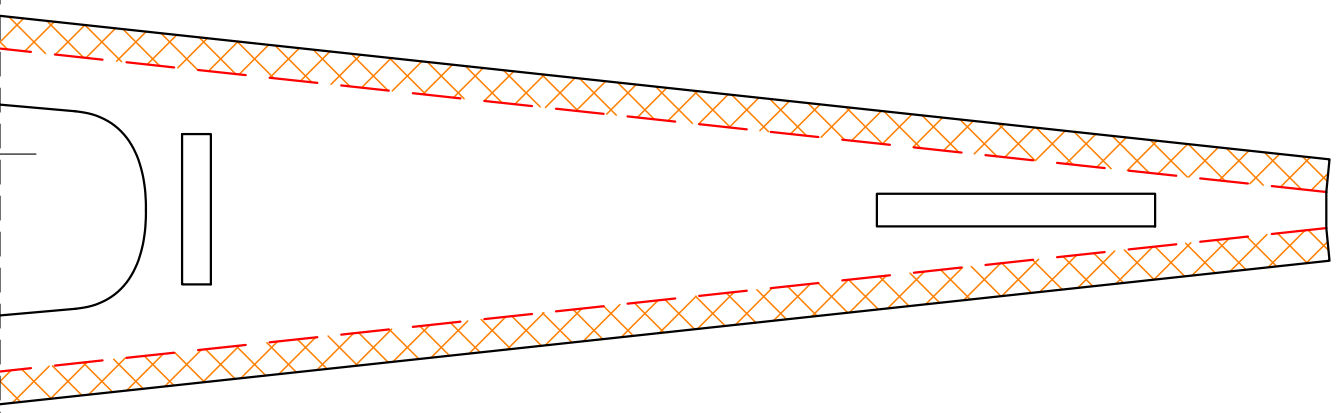
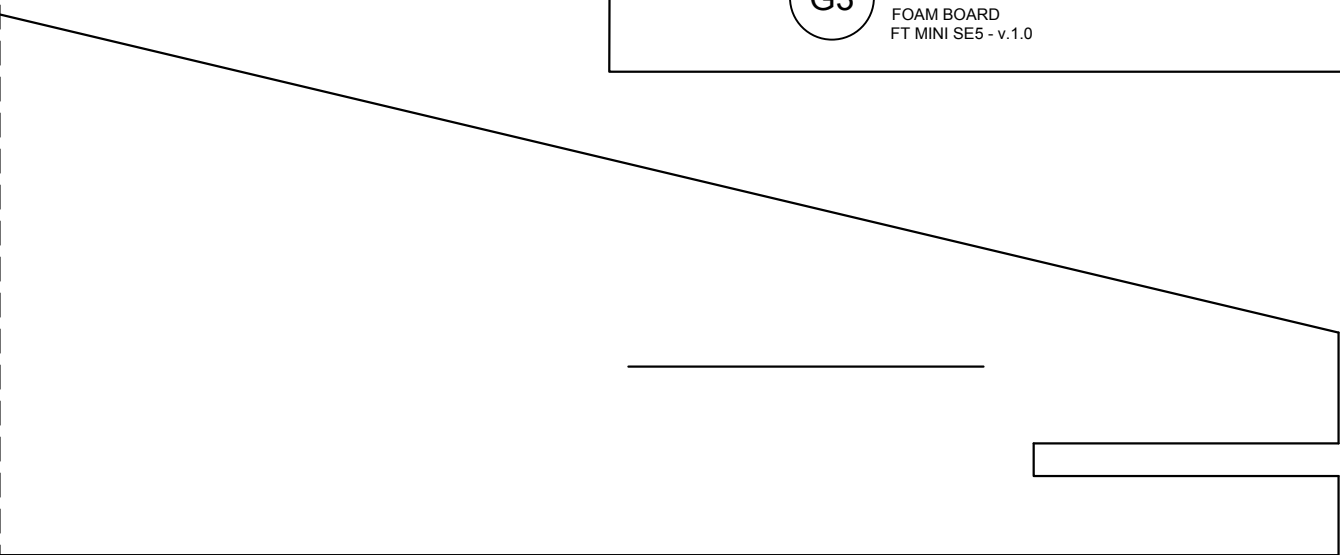
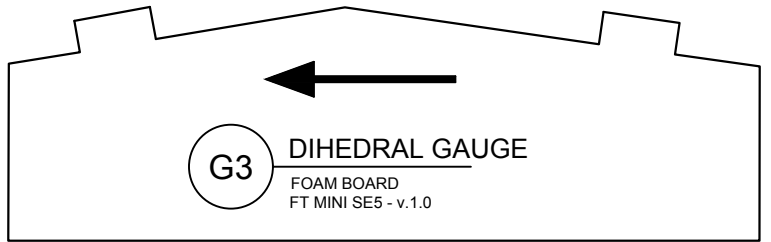

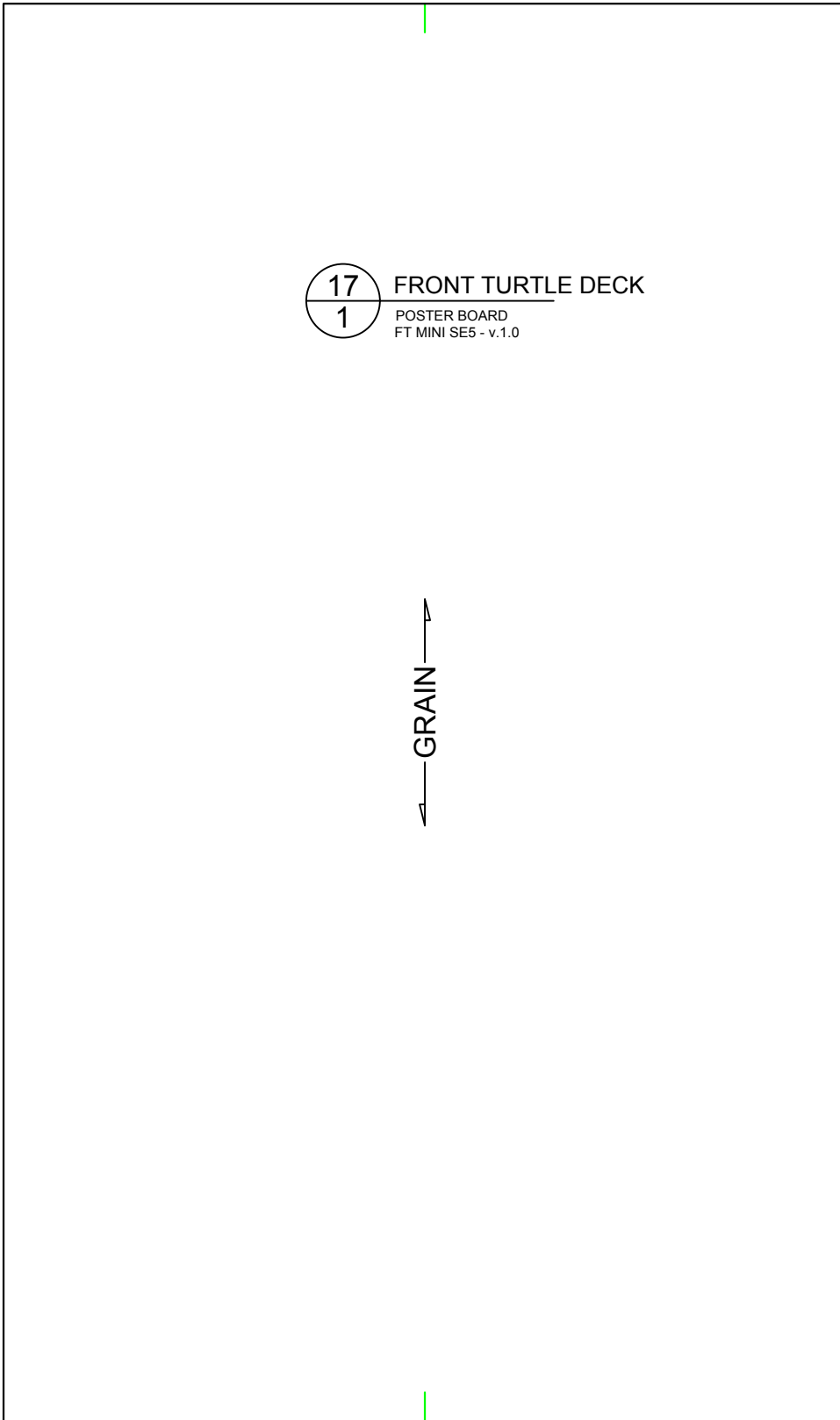

17 FRONT TURTLE DECK
1 POSTER BOARD
FT MINI SE5 - v.1.0

← GRAIN →

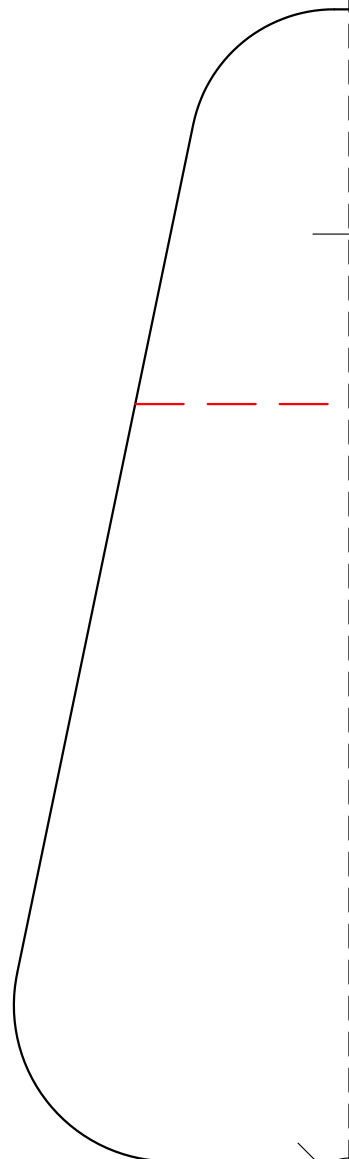

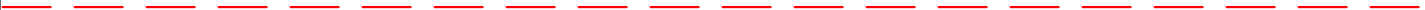
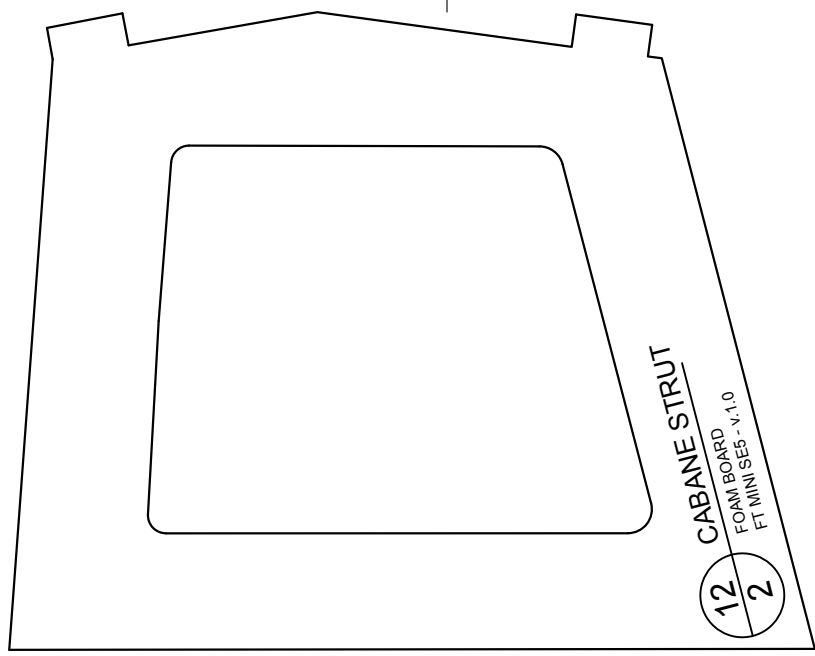

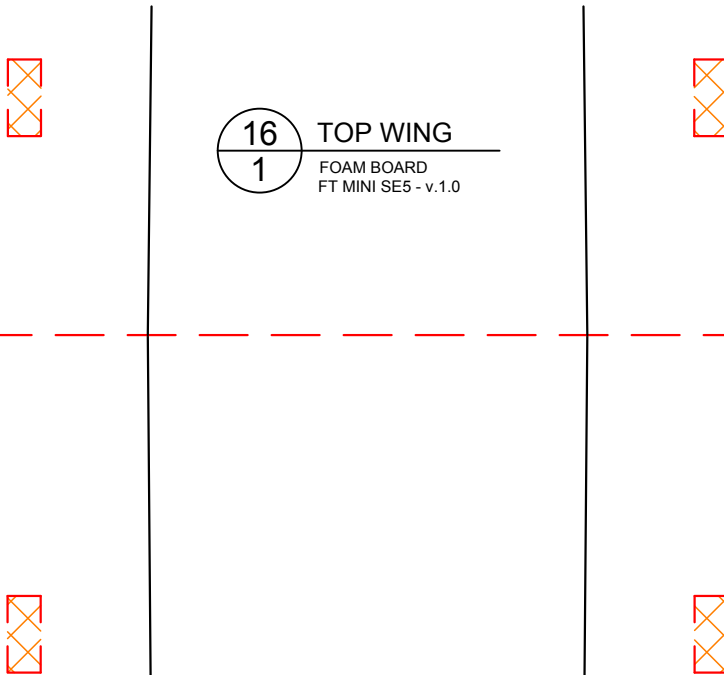
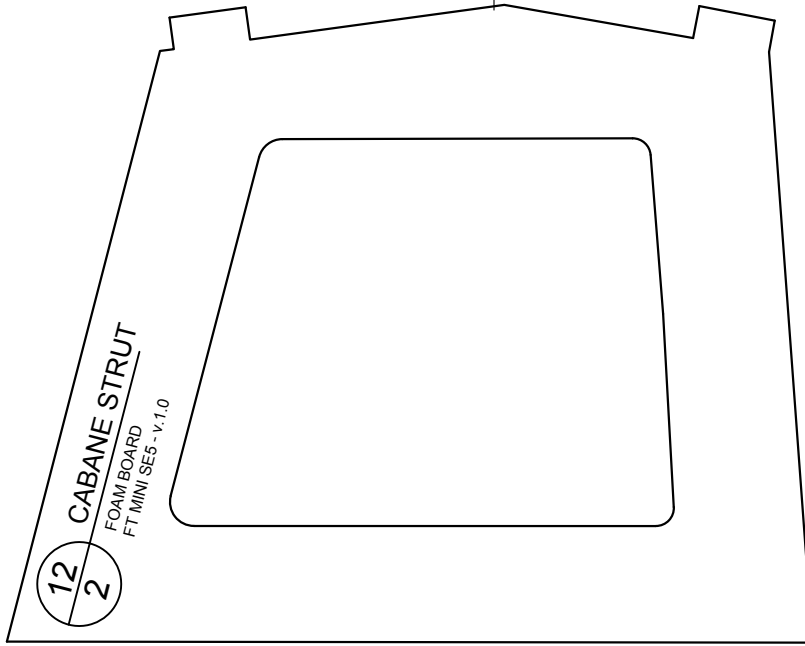

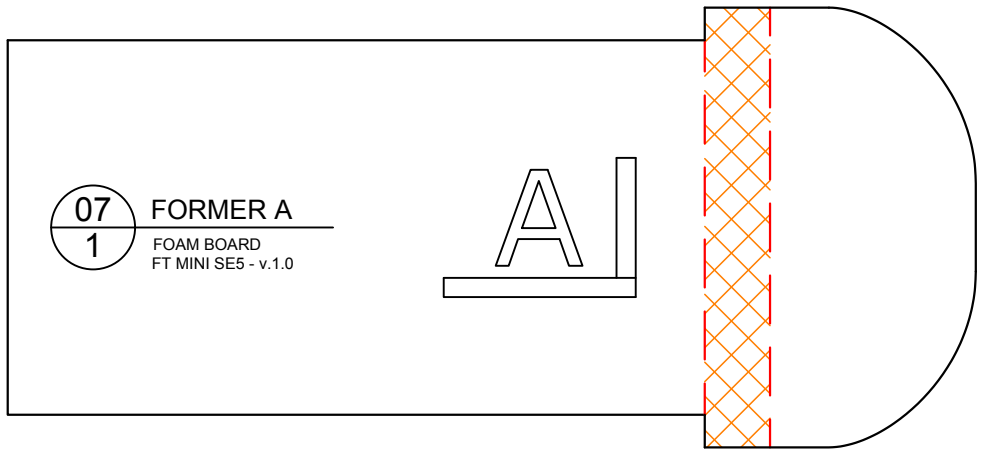

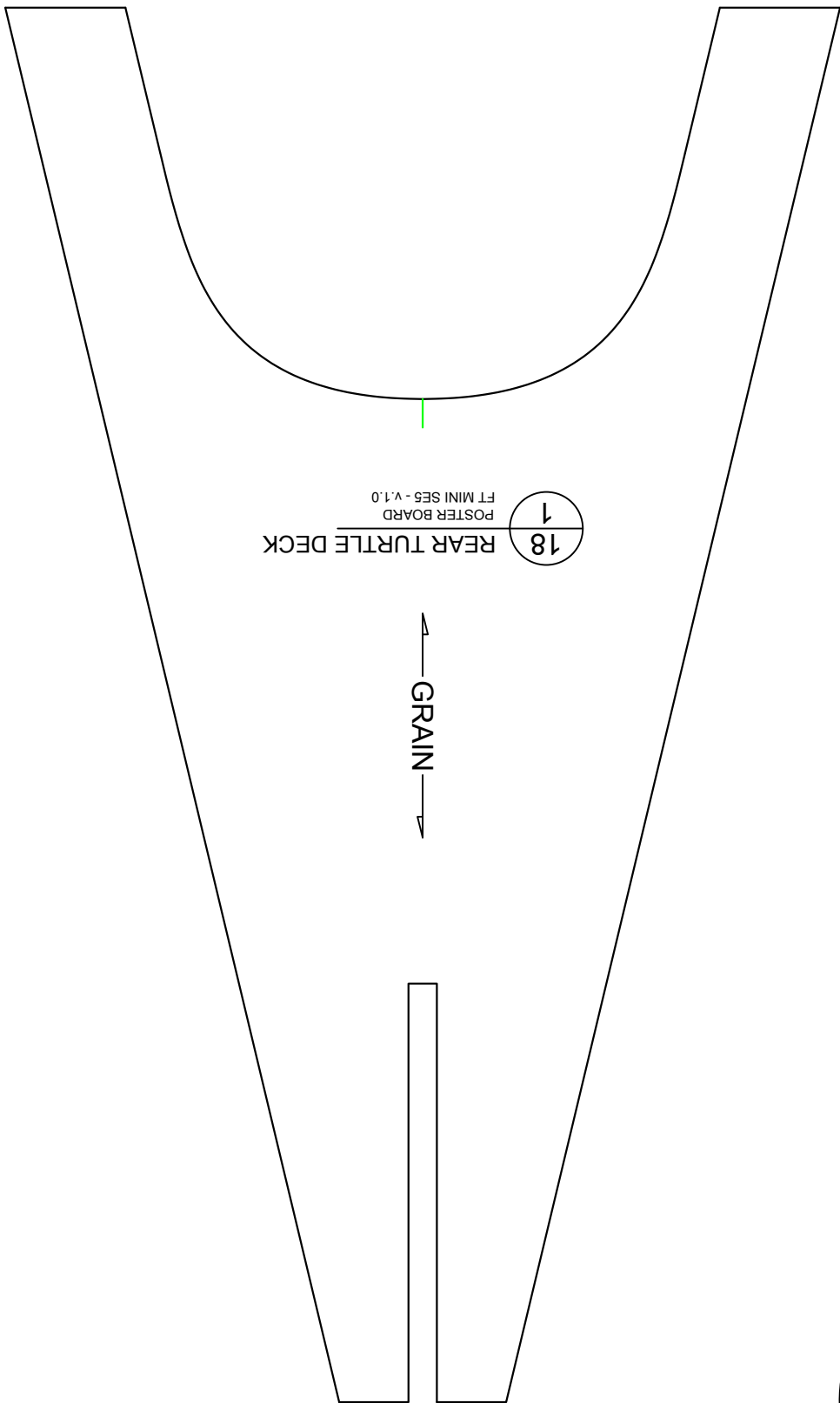

18 REAR TURTLE DECK
1 POSTER BOARD
FT MINI SE5 - v.1.0

GRAIN

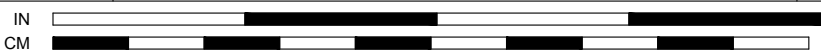

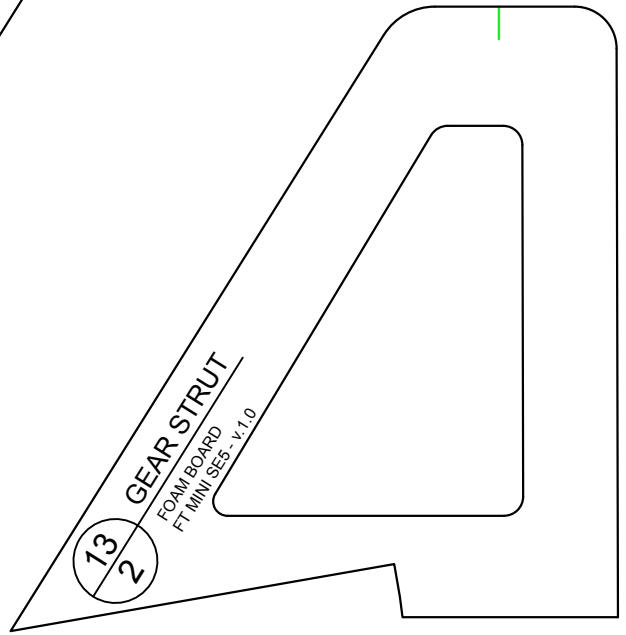
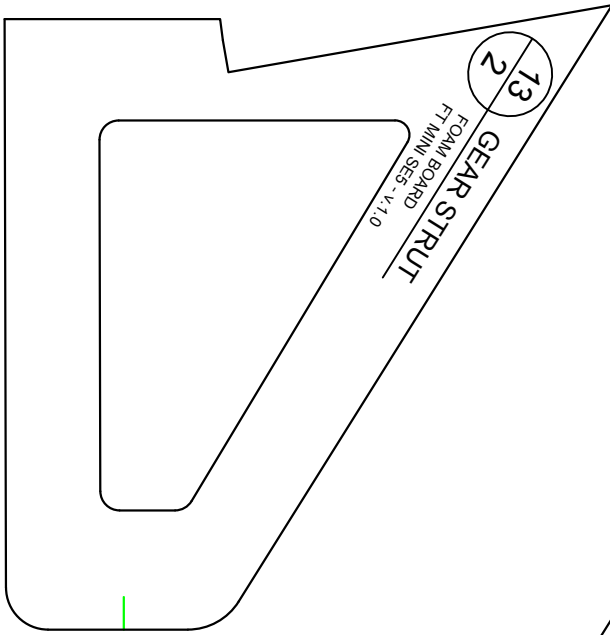

CAVITY
OPPOSITE
SIDE



CAVITY
OPPOSITE
SIDE



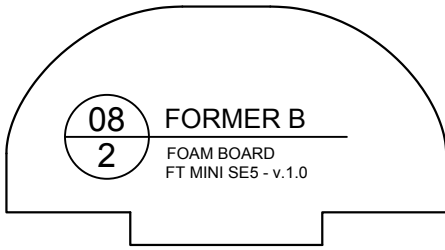

FORMER B

FOAM BOARD
FT MINI SE5 - v.1.0

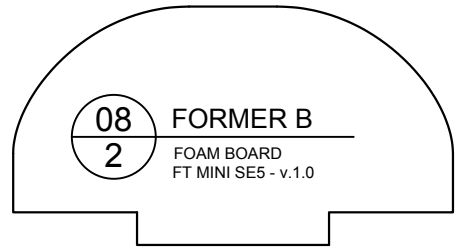

FORMER B

FOAM BOARD
FT MINI SE5 - v.1.0

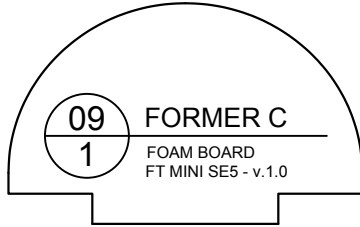

FORMER C

FOAM BOARD
FT MINI SE5 - v.1.0



BOTTOM WING

FOAM BOARD
FT MINI SE5 - v.1.0

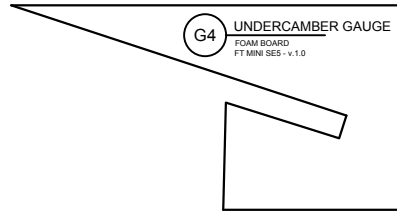
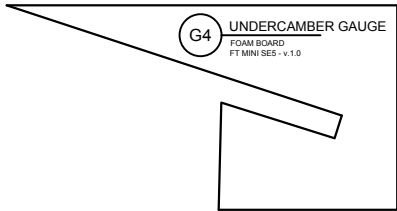
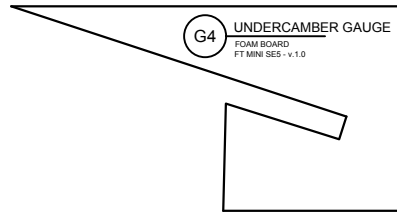
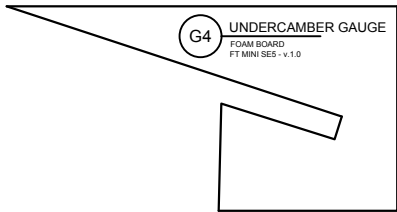

CAVITY
OPPOSITE
SIDE



CAVITY
OPPOSITE
SIDE