



www.flitetest.com

# FT Sparrow

Designed By: Josh Bixler  
Drawing By: Dan Sponholz  
Version: 1.1  
Date: 2017.11.30



## SPECIFICATIONS

DESCRIPTION		IMPERIAL	METRIC
LENGTH		16 in	406 mm
CENTER OF GRAVITY	CG	1.75 in	44.5 mm
WING SPAN		28.5 in	723 mm
WING AREA		180 in <sup>2</sup>	11.6 dm <sup>2</sup>
DRY WEIGHT		6.5 oz	187 g
ALL UP WEIGHT	AUW	9.0 oz	256 g
WING LOADING	WL	7.2 oz/ft <sup>2</sup>	22 g/dm <sup>2</sup>
WING CUBIC LOADING	WCL	6.4	

## RECOMMENDED SETTINGS

	THROW	EXPO
ELEVONS	12°	30%



Build Skill Level :



Pilot Skill Level :





# FT Sparrow: Sheet & Tile Key



A17	B9	A18	A19	B10	A20
S3			A21	B11	A22
			A23	B12	A24

A9	B5	A10	A1	B6	A2
S2			A3	B7	A4
			A5	B8	A6

A1	B1	A2	A3	B2	A4
S1			A7	B4	A8
			A5	B3	A6

A41	B21	A42	A43	B22	A44
S6			A45	B23	A46
			A47	B24	A48

A33	B17	A34	A35	B18	A36
S5			A37	B19	A38
			A39	B20	A40

A25	B13	A26	A27	B14	A28
S4			A31	B16	A32
			A29	B15	A30

A65	B33	A66	A67	B34	A68
S9			A69	B35	A70
			A71	B36	A72

A57	B29	A58	A59	B30	A60
S8			A61	B31	A62
			A63	B32	A64

A49	B25	A50	A51	B26	A52
S7			A53	B27	A54
			A55	B28	A56



# Drawing Key



## FOLD TYPES

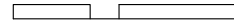
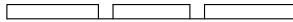
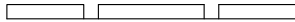
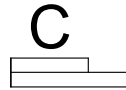
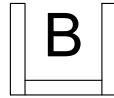
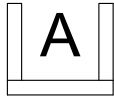

A - FOLD (ABOVE)

B - FOLD (BESIDE)

C - FOLD (COVER)

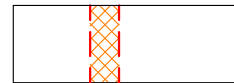
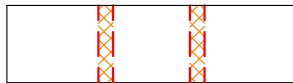
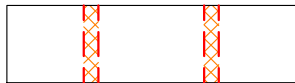

## LINE TYPE/COLOR

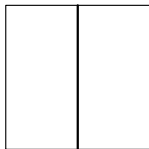

CUT

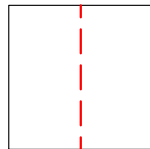
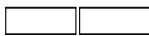

50% SCORE

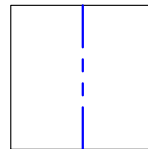
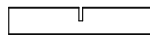

CREASE

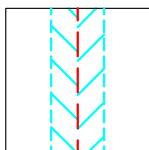
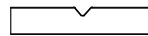

45° DOUBLE BEVEL

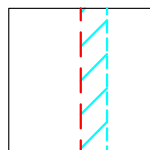

45° SINGLE BEVEL

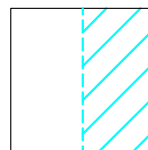

EDGE BEVEL

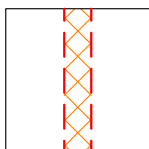
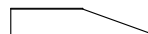

CAVITY

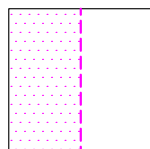

REMOVE PAPER

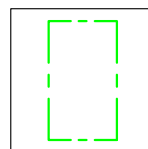

REFERENCE/  
OPTIONAL

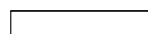

## SYMBOLS

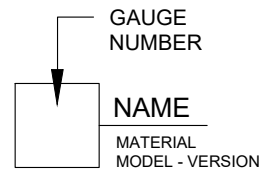
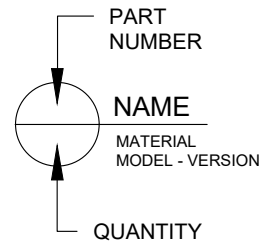

CENTER OF GRAVITY (CG)



IN  
CM

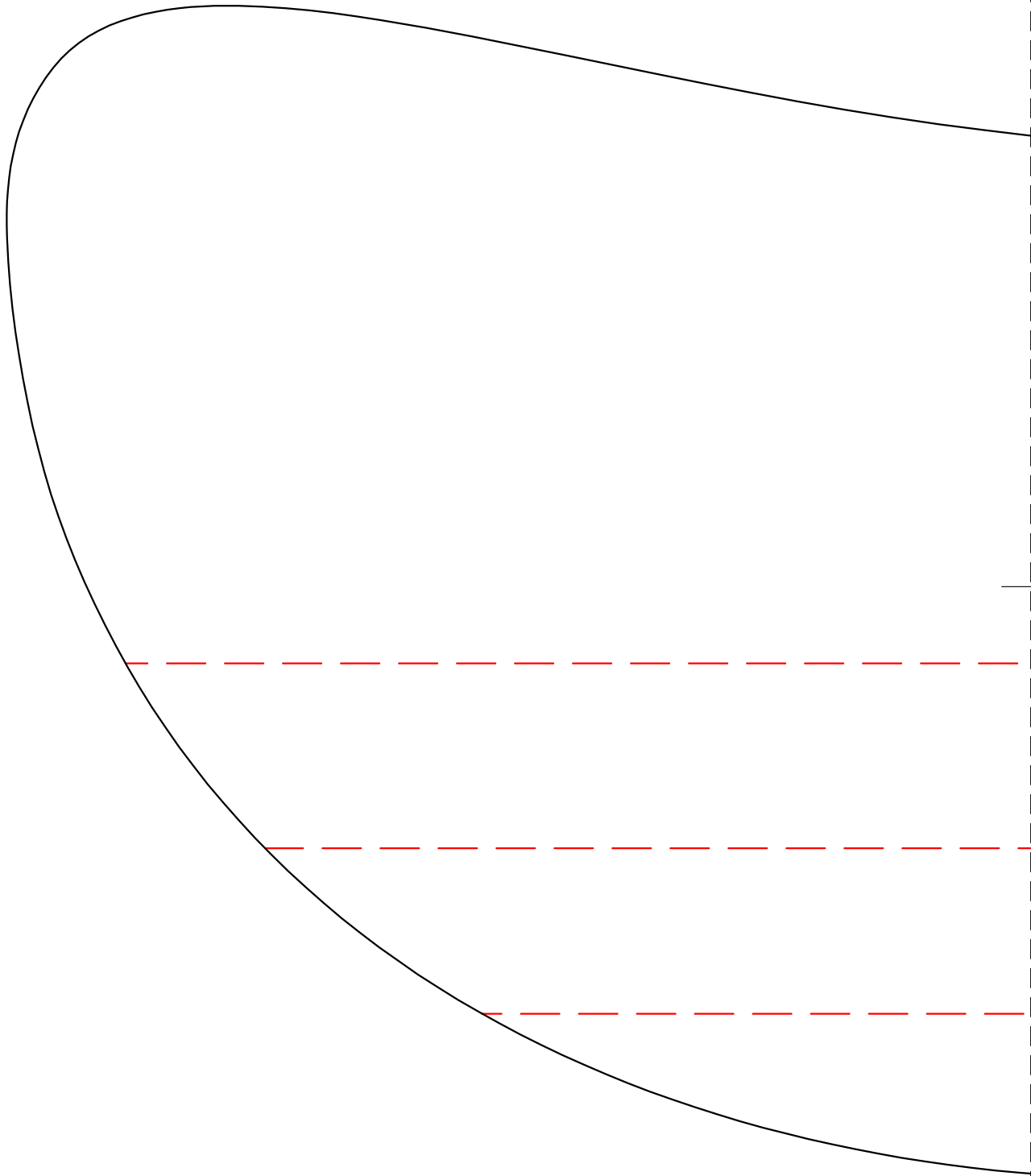



5 WING  
1 FOAM BOARD  
FT SPARROW - v.1.1

GLUE SPAR HERE

45° DO



GLUE SPAR HERE

DOUBLE BEVEL

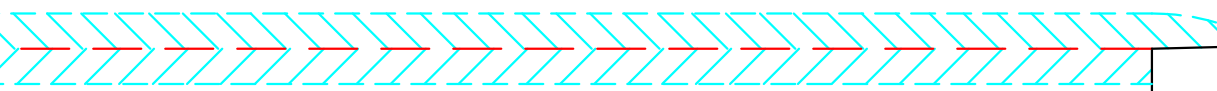

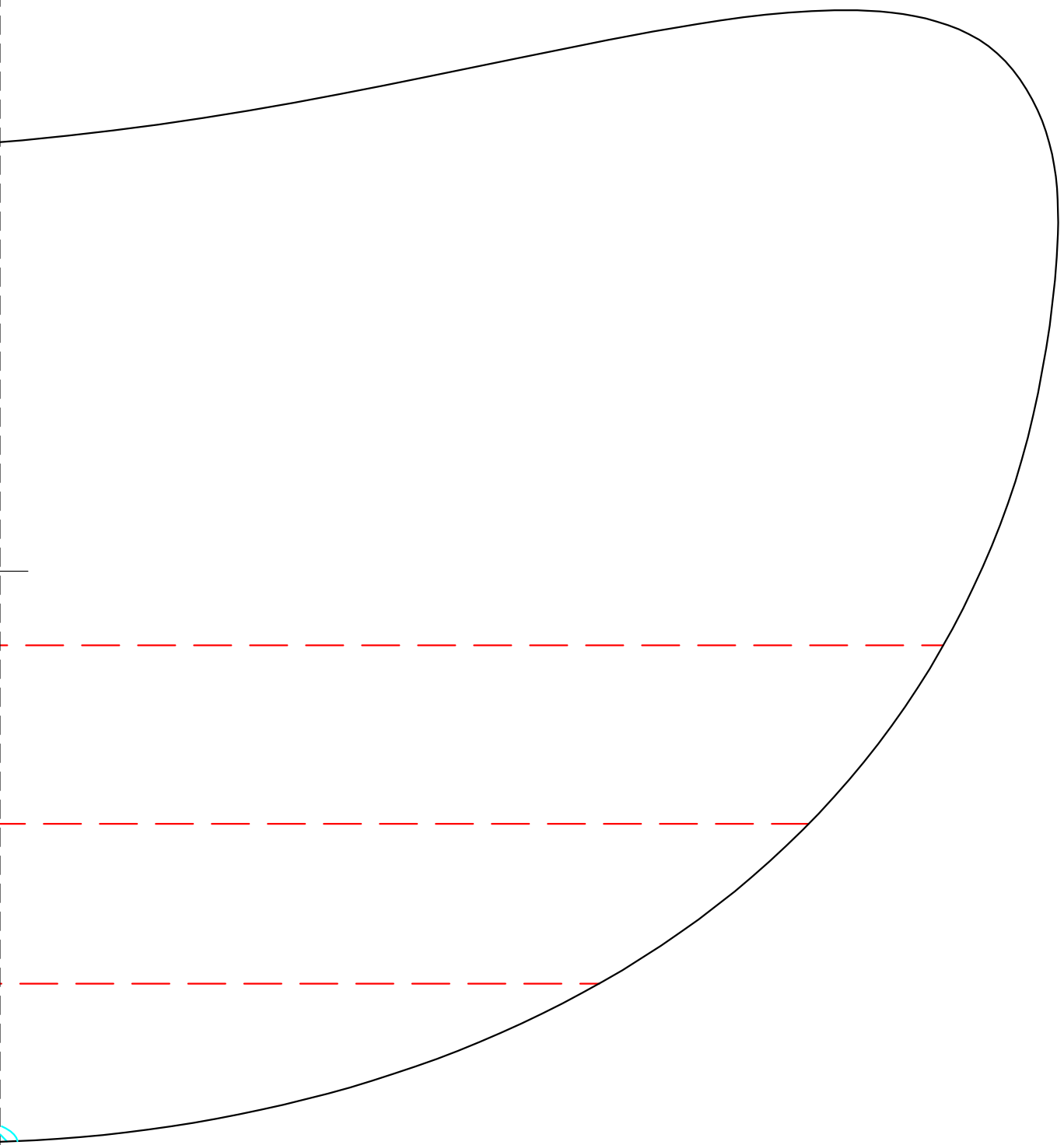

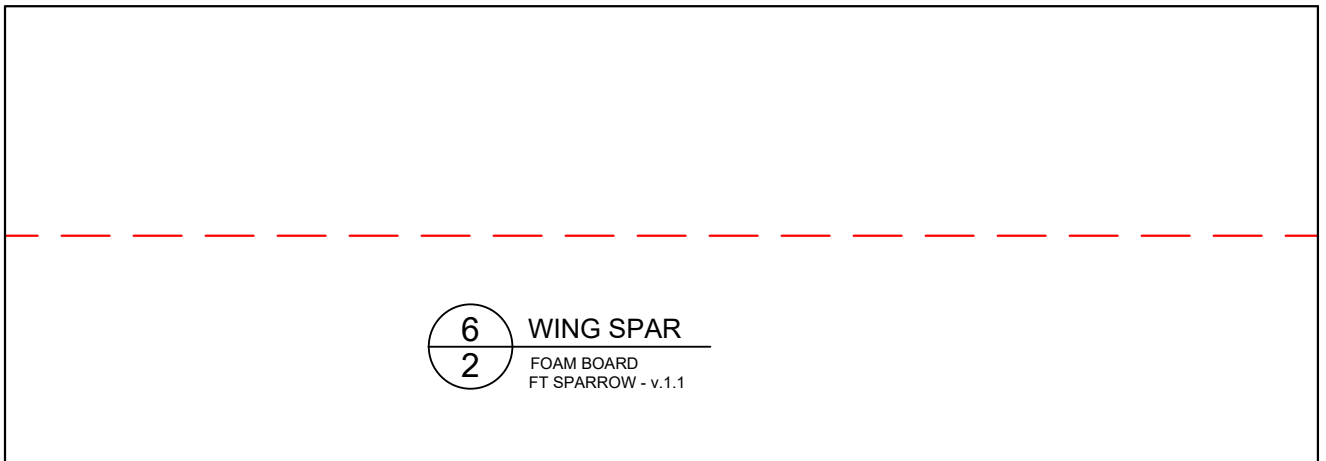
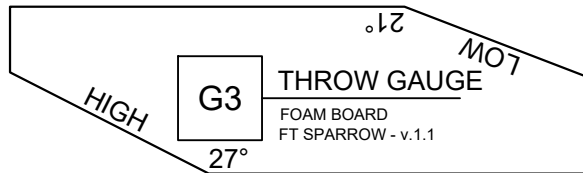
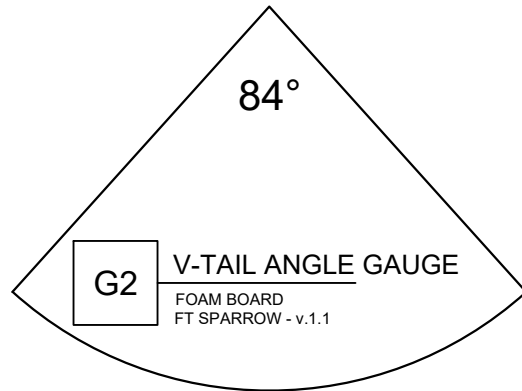
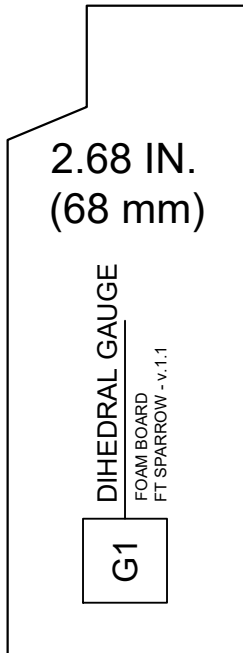
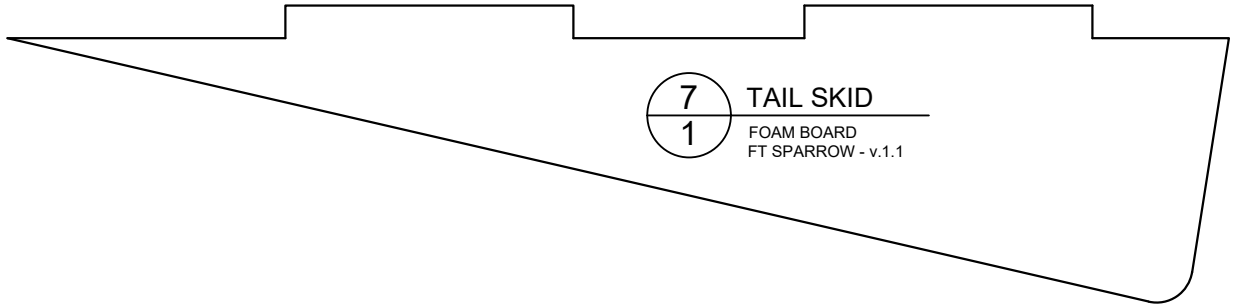



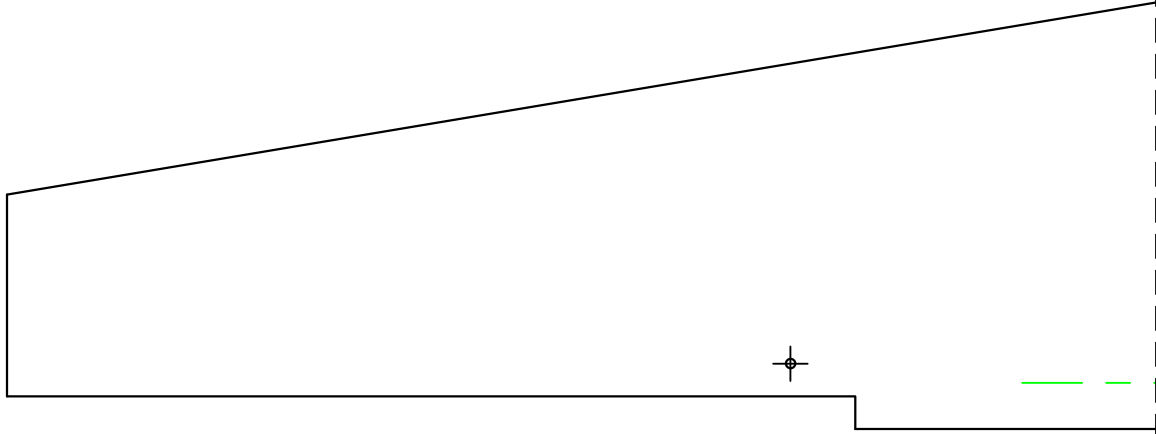
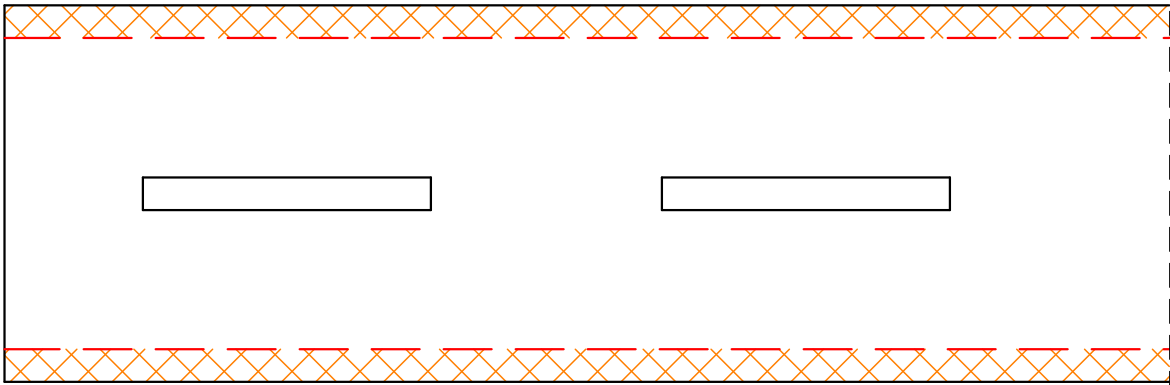
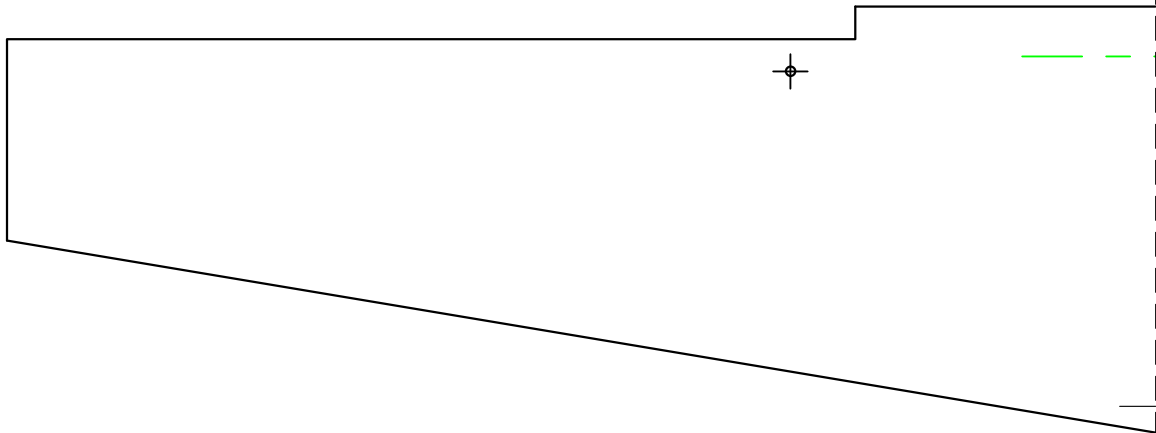
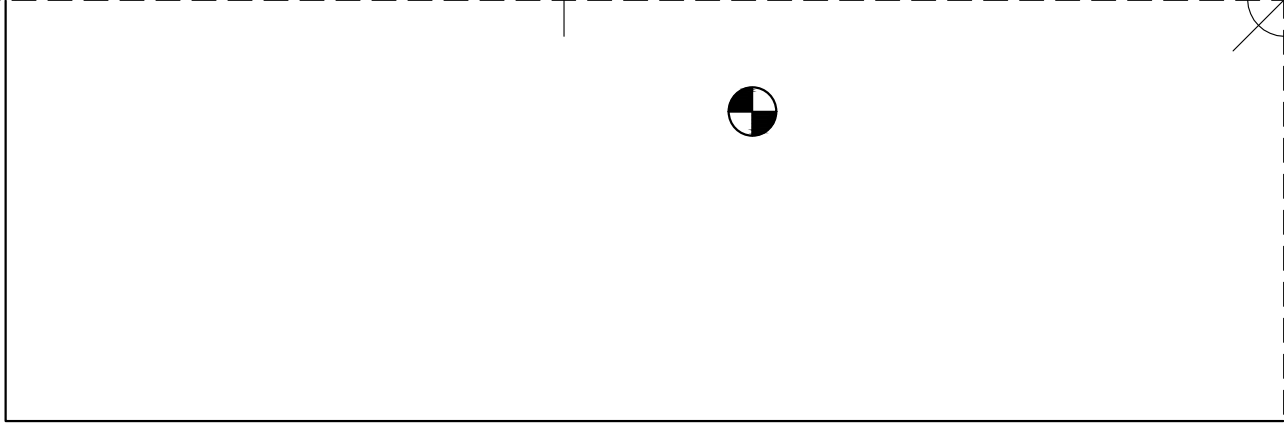



FUSELAGE

FOAM BOARD  
FT SPARROW - v.1.1

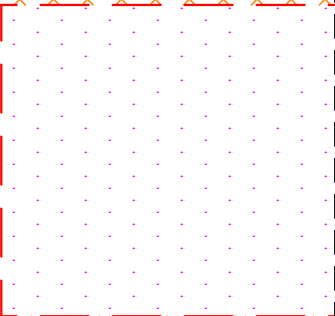
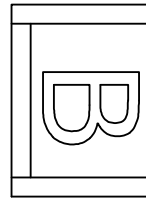
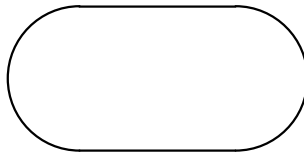

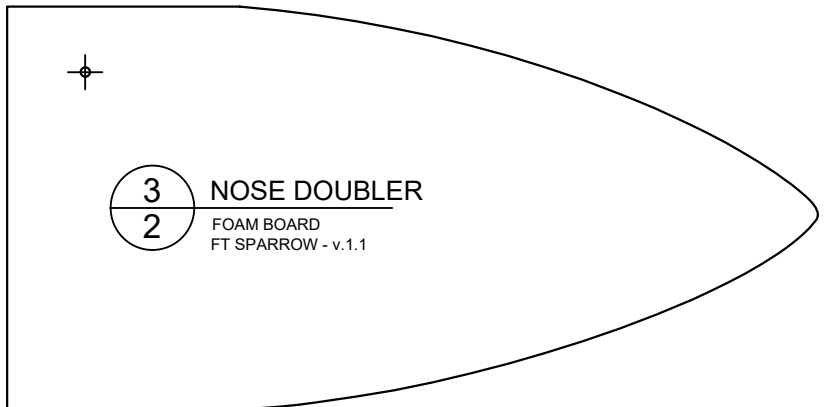
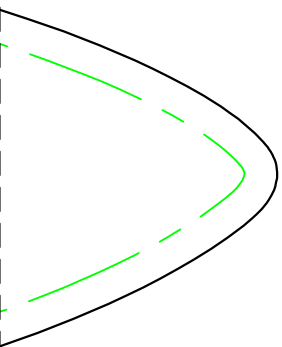
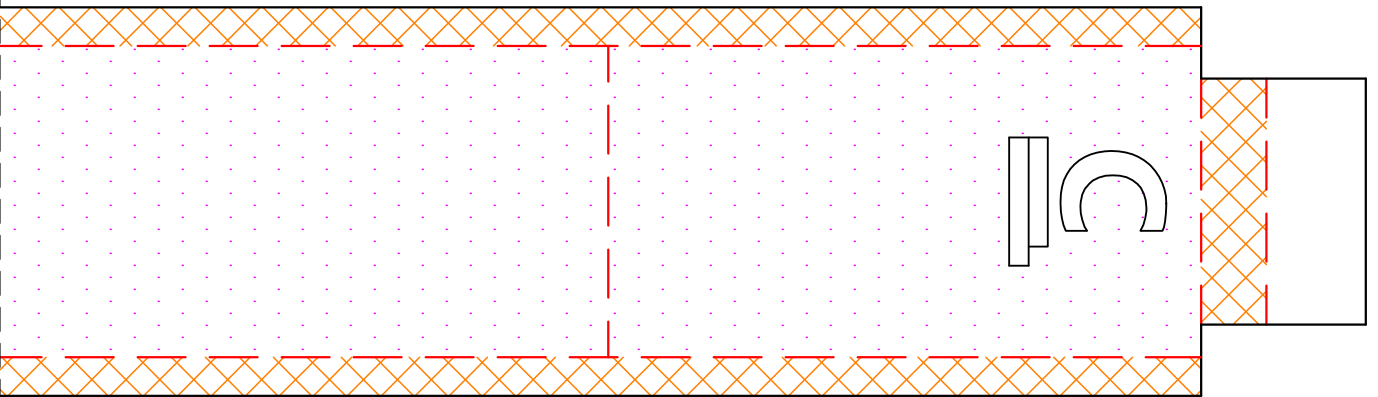
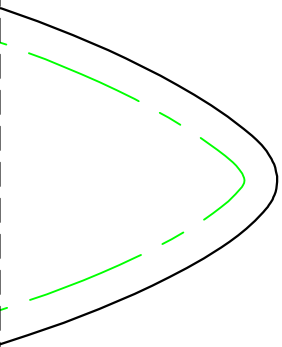
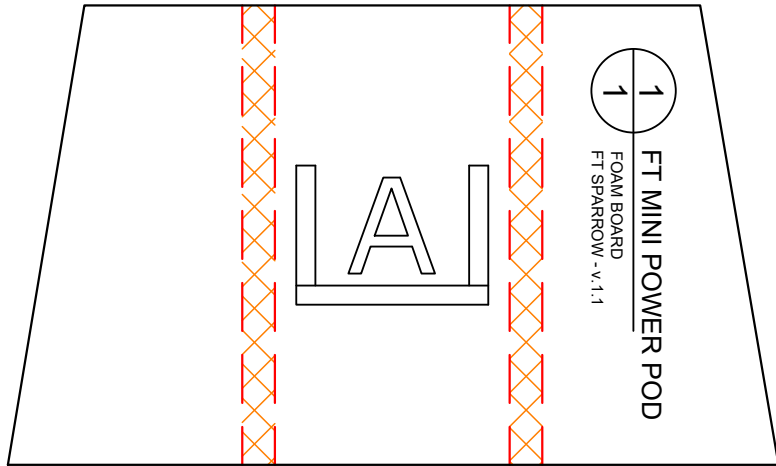



**FT MINI FIREWALL**

**HOBBY GRADE PLYWOOD**  
1/16" (1.6 mm) THICK

**4A**  
**1** **TAIL RIGHT**  
FOAM BOARD  
FT SPARROW - v.1.1



**FT MINI CONTROL HORN**



**HOBBY GRADE PLYWOOD**  
1/16" (1.6 mm) THICK

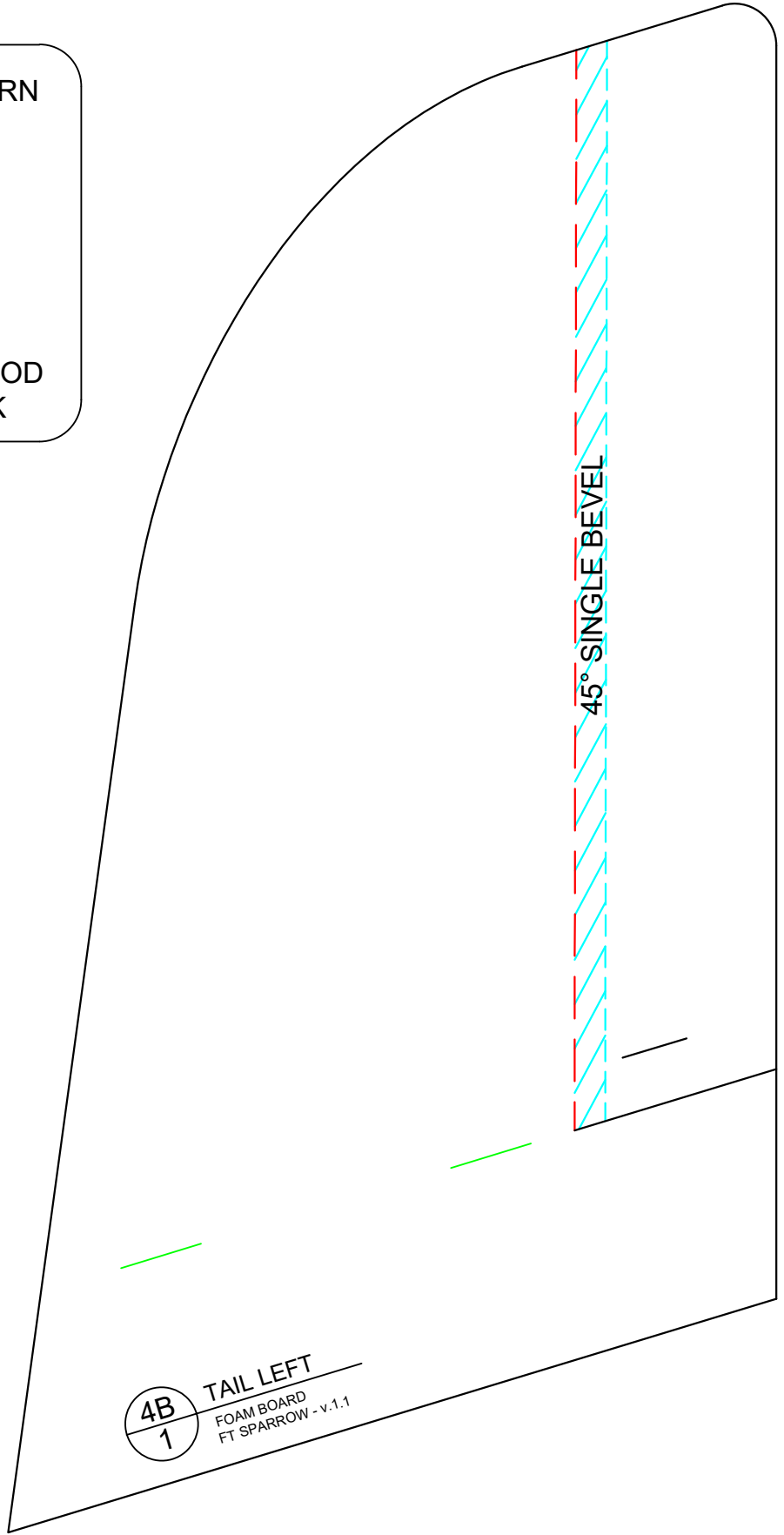

**4B**  
**1**

**TAIL LEFT**  
FOAM BOARD  
FT SPARROW - v.1.1