



www.flitetest.com

FT X-29

Designed By: Andres Lu
Drawing By: Dan Sponholz
Version: 1.0
Date: 2017.09.20



SPECIFICATIONS

DESCRIPTION		IMPERIAL	METRIC
LENGTH		45.5 in	1155.7 mm
CENTER OF GRAVITY	CG	22.75 in	577.85 mm
WING SPAN		27.5 in	698.50 mm
WING AREA		237.89 in ²	15.35 dm ²
DRY WEIGHT		26.4 oz	748.4 g
ALL UP WEIGHT	AUW	35.2 oz	998.4 g
WING LOADING	WL	21.3 oz/ft ²	65.2 g/dm ²
WING CUBIC LOADING	WCL	16.6	

RECOMMENDED SETTINGS

	THROW	EXPO
AILERON	12°	30%
ELEVATOR	12°	30%
RUDDER	12°	30%



Build Skill Level :



Pilot Skill Level :





FT X-29: Sheet & Tile Key



A1 B1 A2	A3 B2 A4	S1
A5 B3 A6	A7 B4 A8	

A9 B5 A10	A11 B6 A12	S2
A13 B7 A14	A15 B8 A16	

A17 B9 A18	A19 B10 A20	S3
A21 B11 A22	A23 B12 A24	

A25 B13 A26	A27 B14 A28	S4
A29 B15 A30	A31 B16 A32	

A33 B17 A34	A35 B18 A36	S5
A37 B19 A38	A39 B20 A40	

A41 B21 A42	A43 B22 A44	S6
A45 B23 A46	A47 B24 A48	

A49 B25 A50	A51 B26 A52	S7
A53 B27 A54	A55 B28 A56	

A57 B29 A58	A59 B30 A60	S8
A61 B31 A62	A63 B32 A64	

A65 B33 A66	A67 B34 A68	S9
A69 B35 A70	A71 B36 A72	



Drawing Key



FOLD TYPES



A - FOLD (ABOVE)

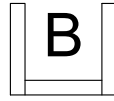

B - FOLD (BESIDE)

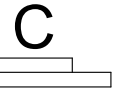
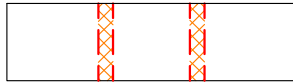

C - FOLD (COVER)

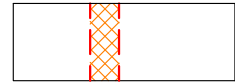

LINE TYPE/COLOR

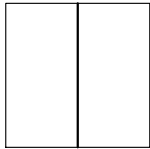

CUT

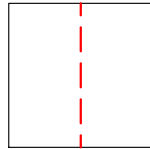

50% SCORE

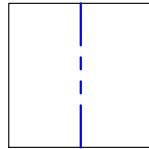
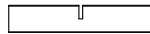

CREASE

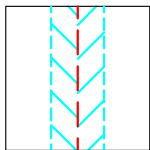
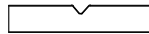

45° DOUBLE BEVEL

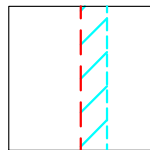

45° SINGLE BEVEL

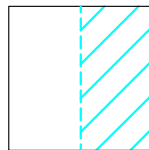

EDGE BEVEL

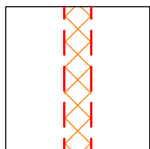

CAVITY

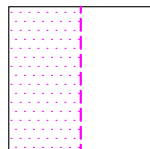

REMOVE PAPER

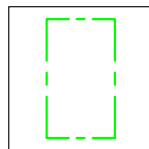
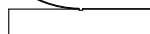

REFERENCE/
OPTIONAL

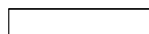

SYMBOLS

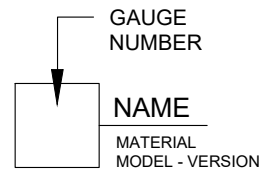
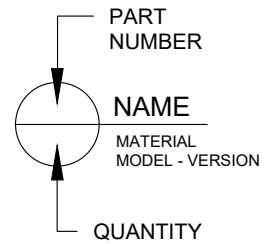

CENTER OF GRAVITY (CG)

FT X-29

Designed By: Andres Lu
Drawing By: Dan Sponholz
Version: 1.0
Date: 2017.09.20



www.flitetest.com

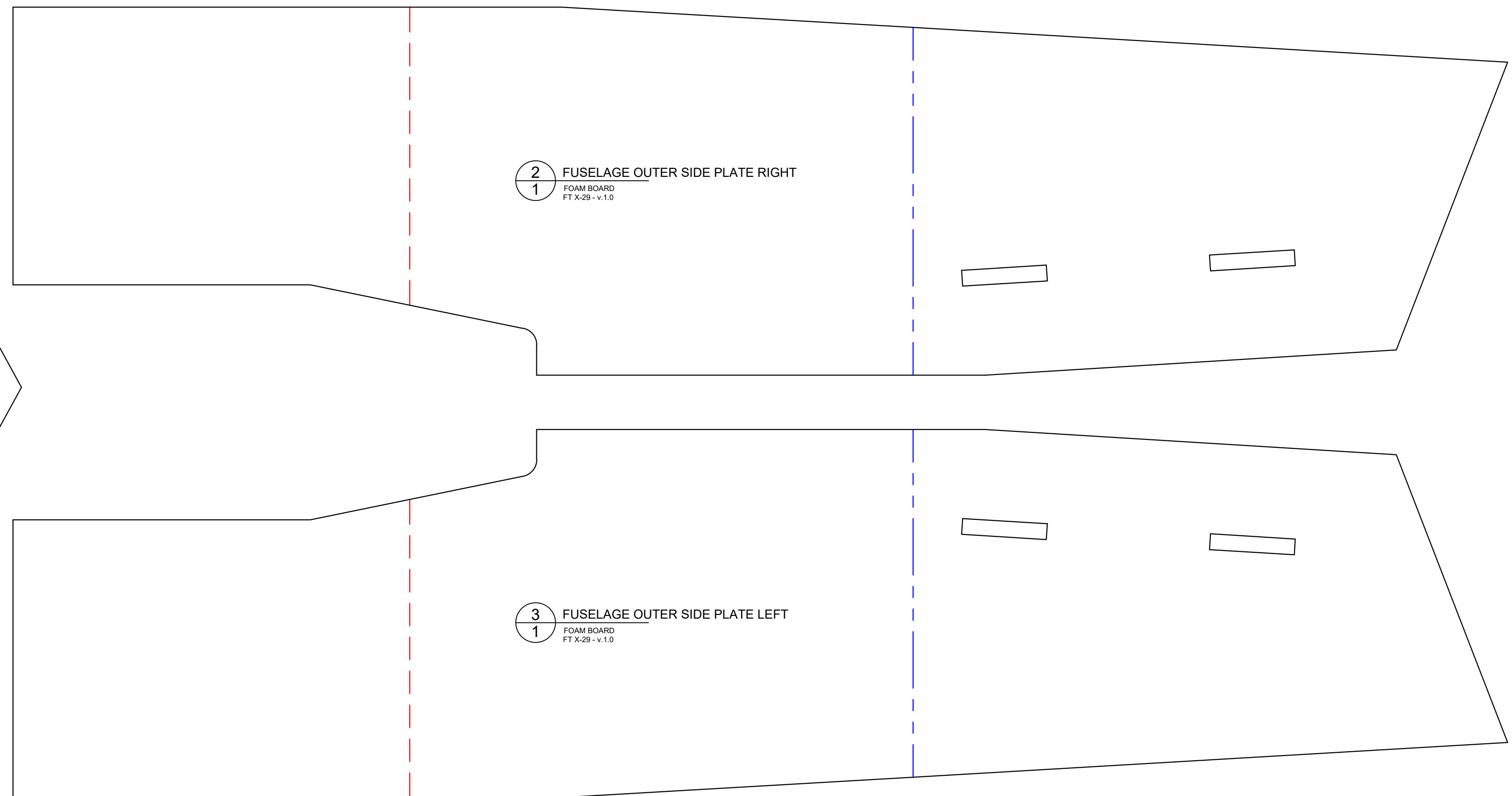
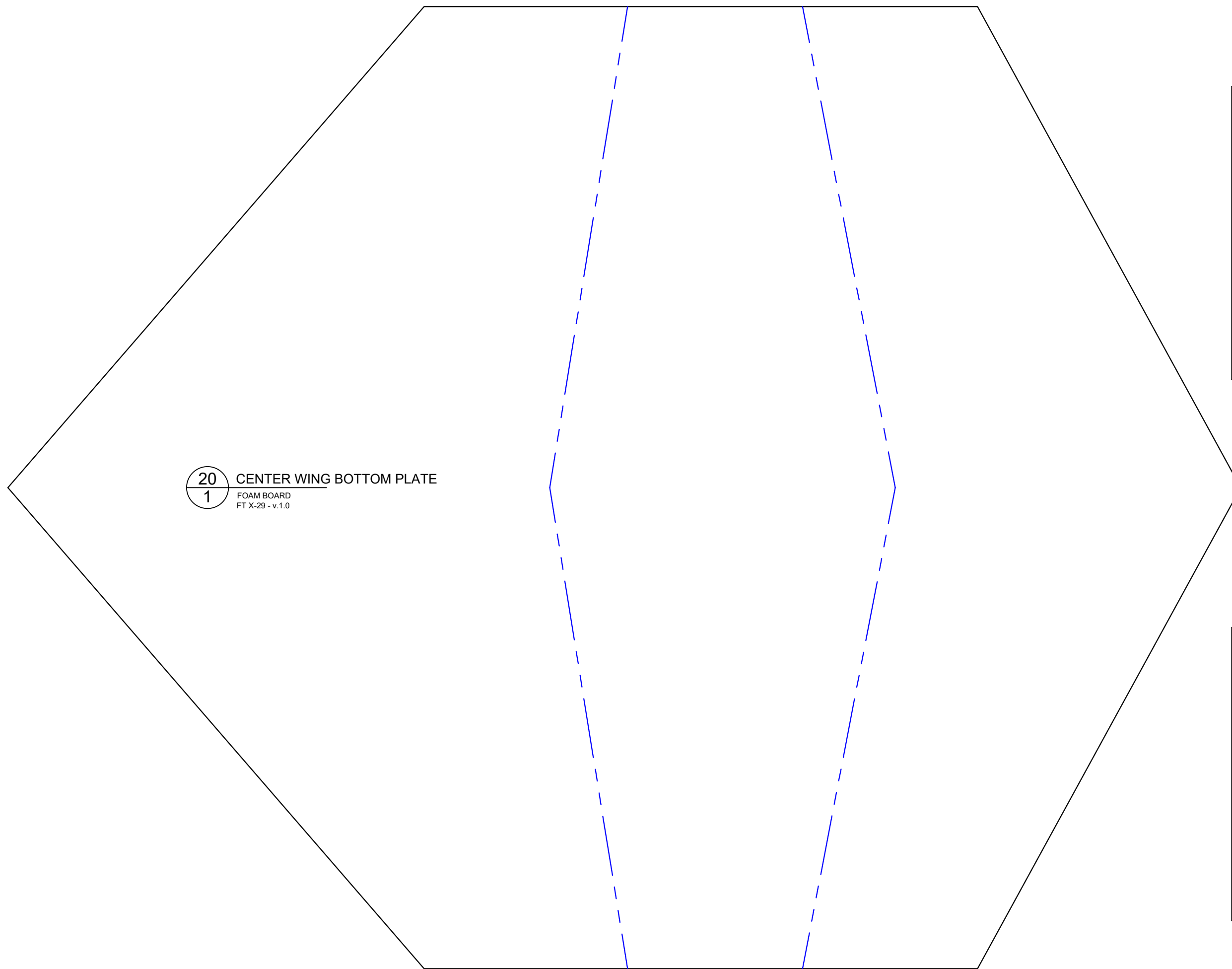
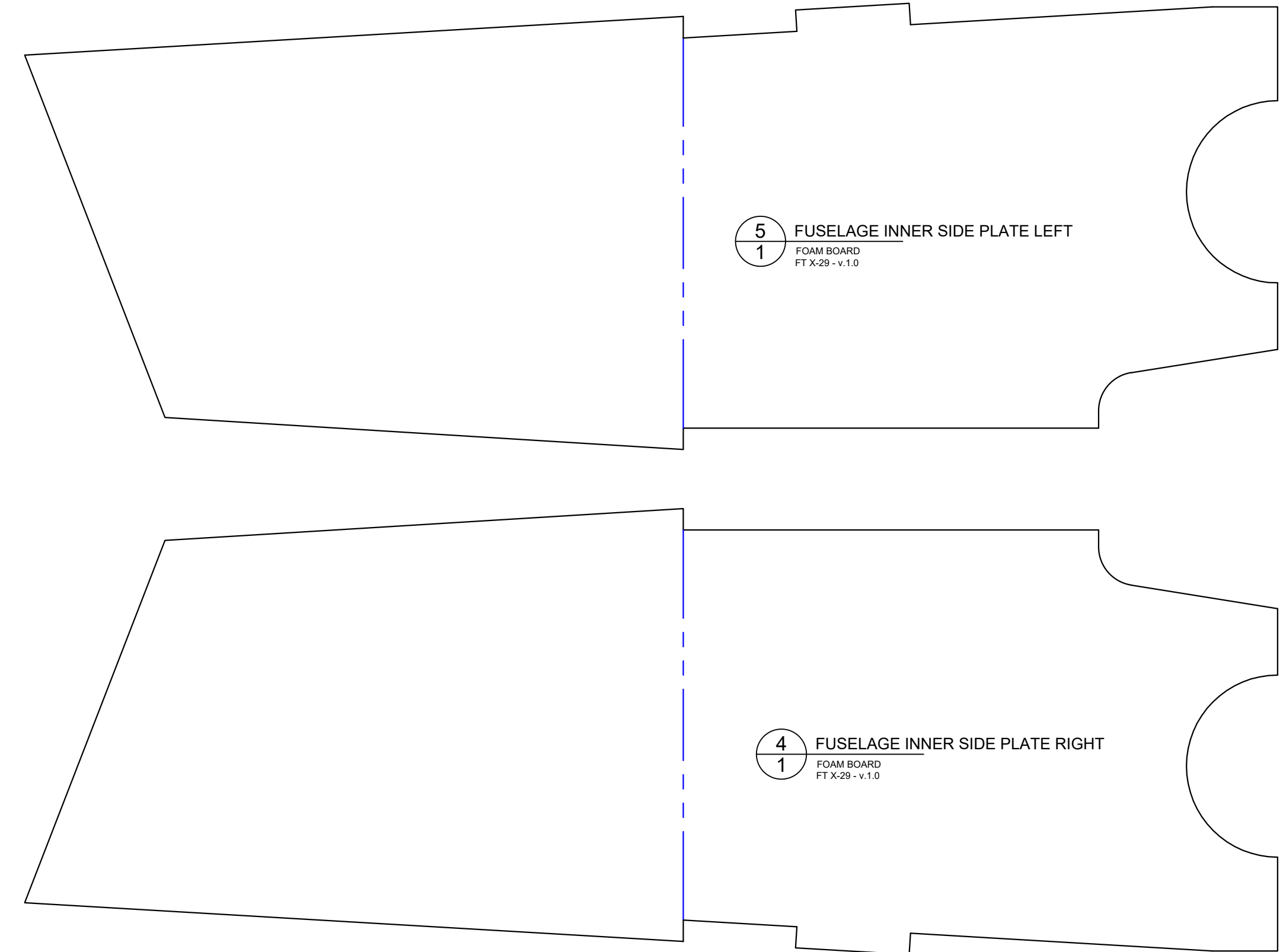
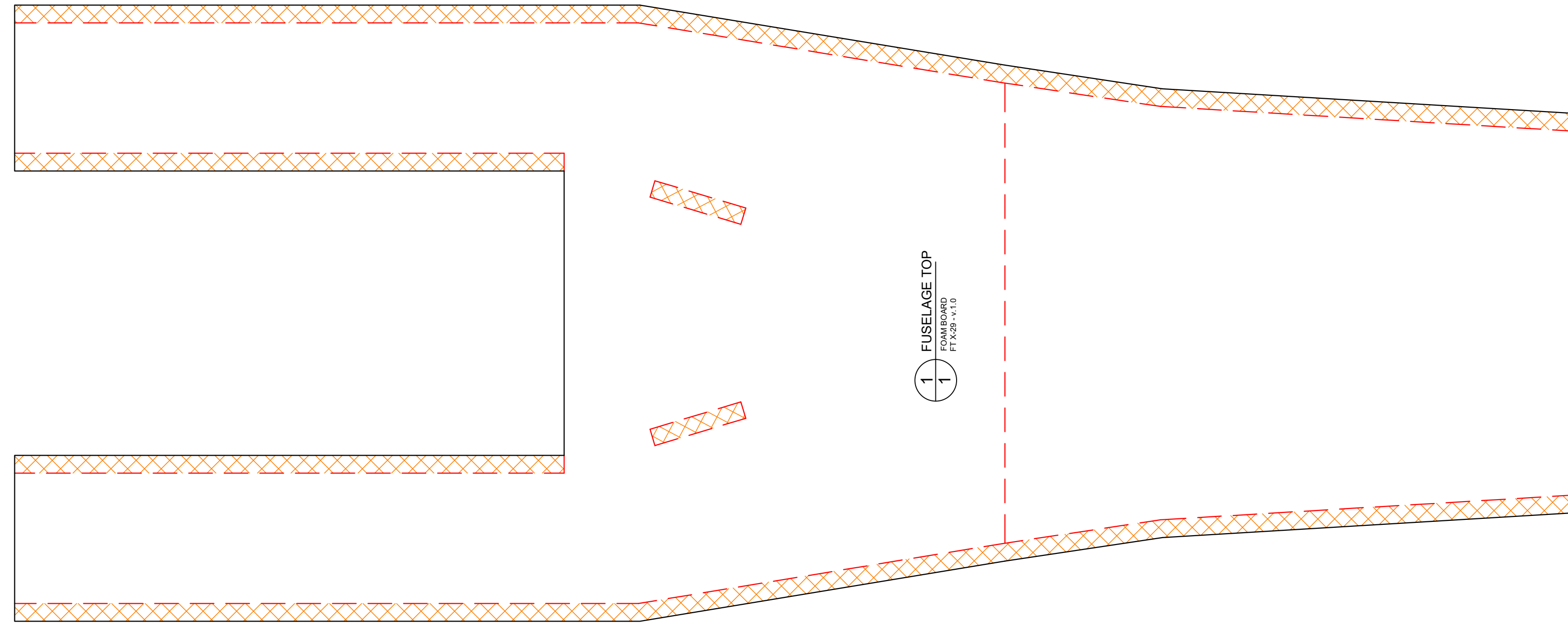

FT X-29

Designed By: Andres Lu
Drawing By: Dan Sponholz
Version: 1.0
Date: 2017.09.20

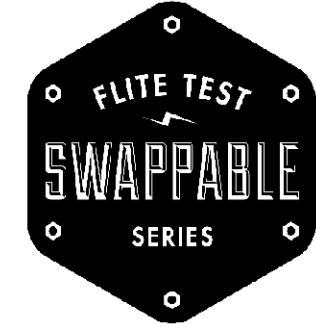

www.flitetest.com

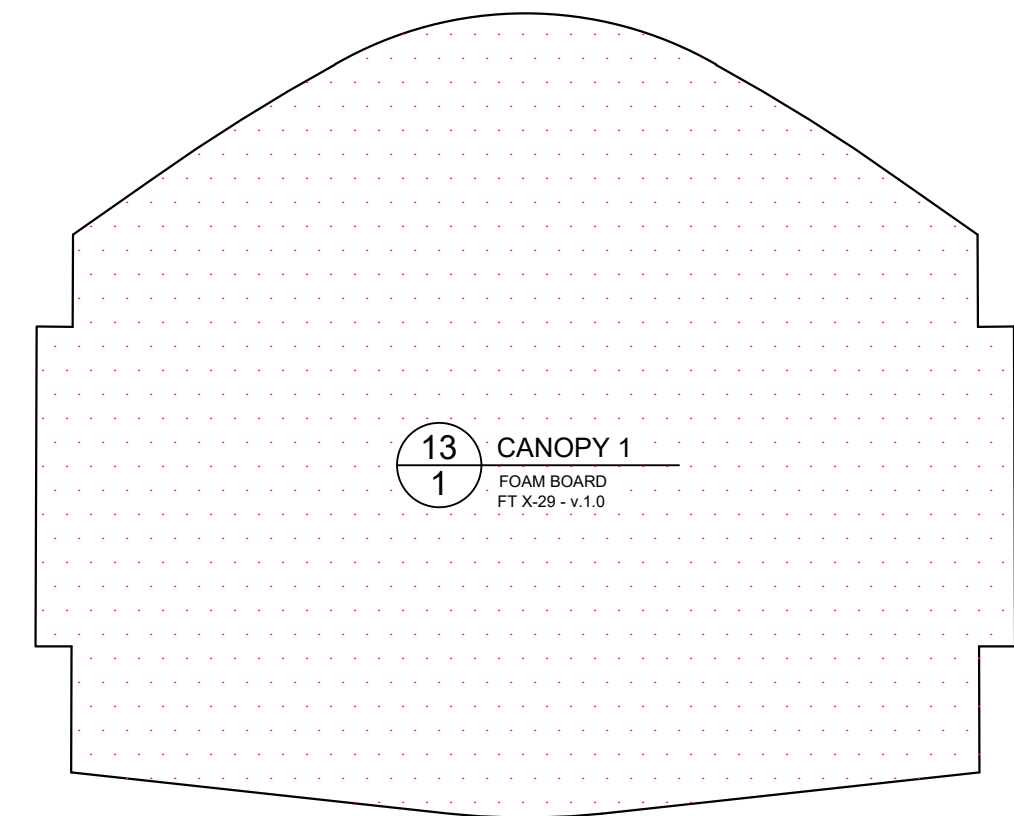

13 CANOPY 1
1
FOAM BOARD
FT X-29 - v.1.0

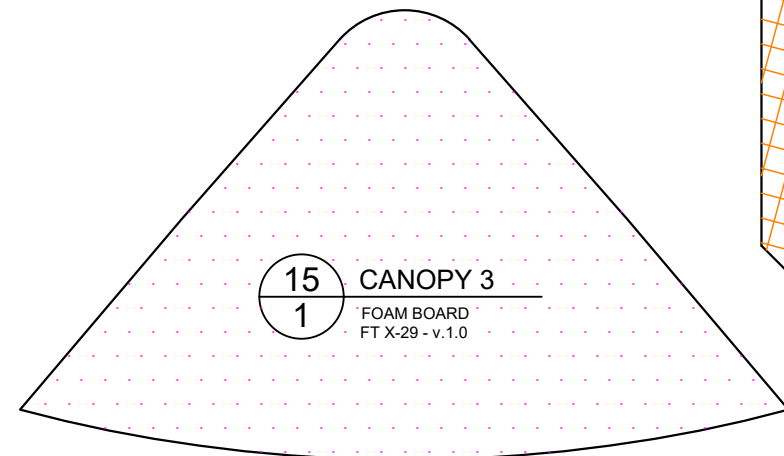

15 CANOPY 3
1
FOAM BOARD
FT X-29 - v.1.0

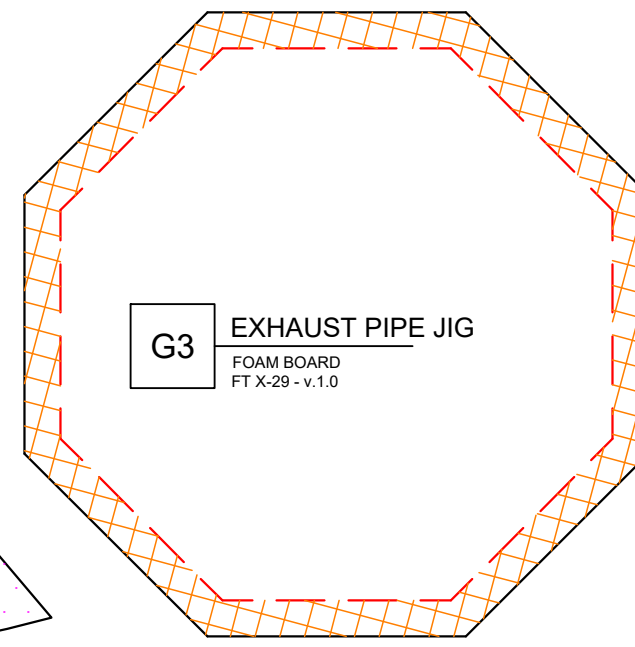

G3 EXHAUST PIPE JIG
FOAM BOARD
FT X-29 - v.1.0

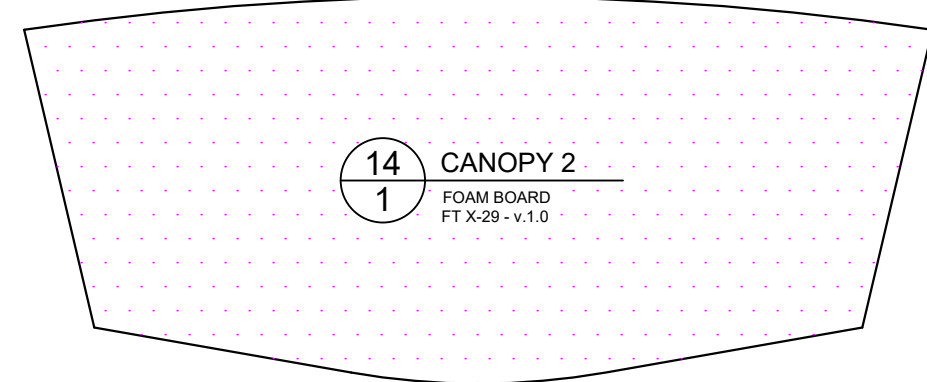

14 CANOPY 2
1
FOAM BOARD
FT X-29 - v.1.0

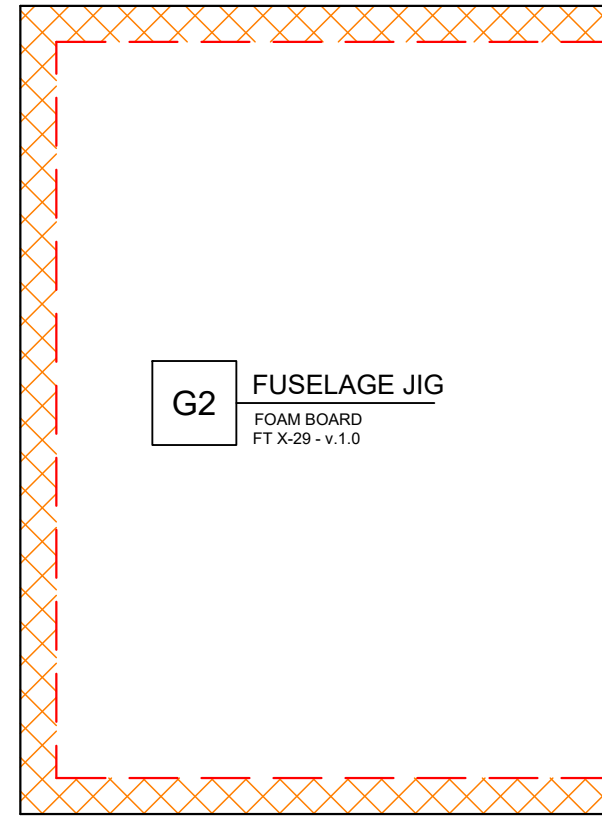

G2 FUSELAGE JIG
FOAM BOARD
FT X-29 - v.1.0

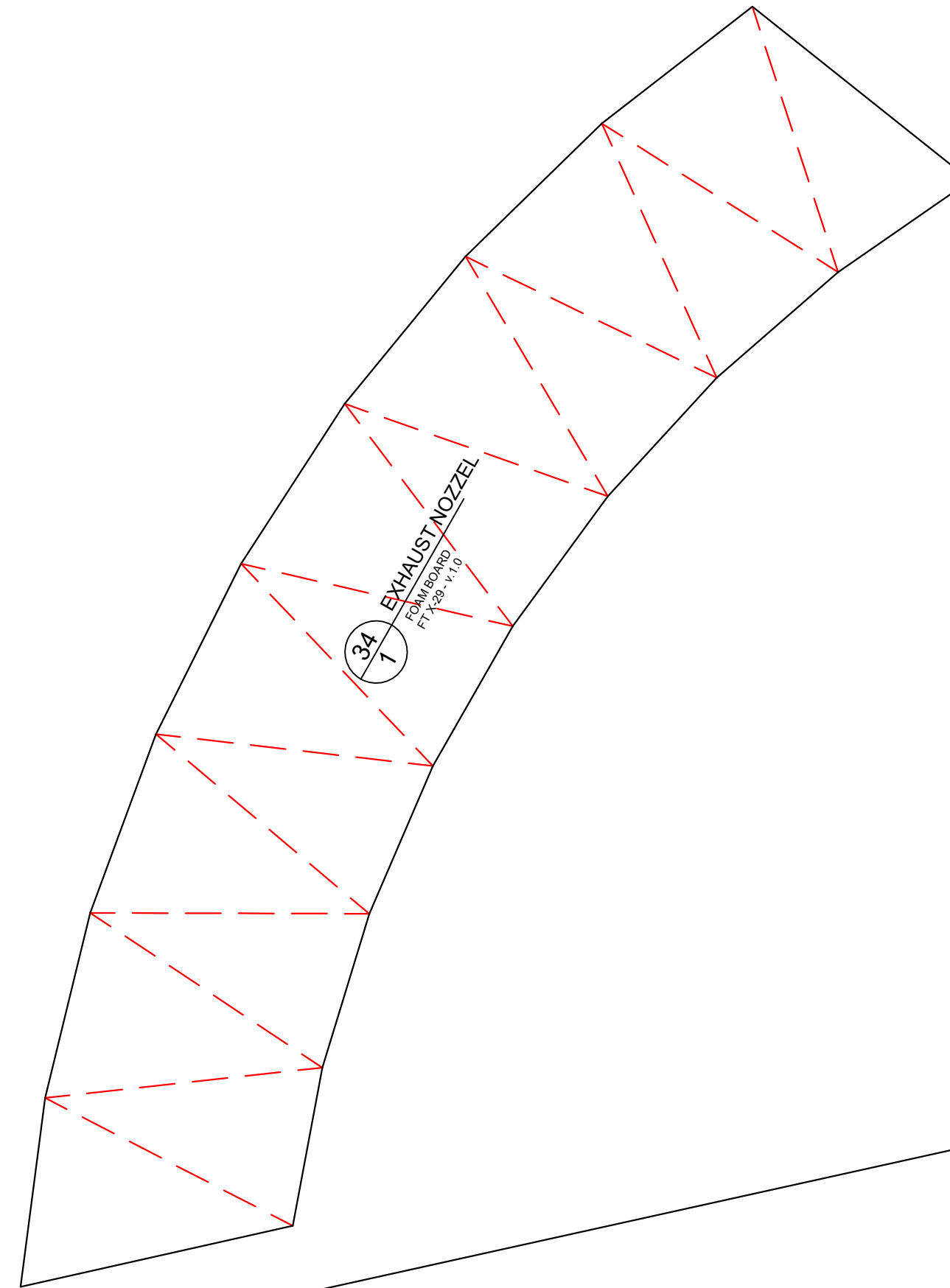

34 EXHAUST NOZZEL
1
FOAM BOARD
FT X-29 - v.1.0

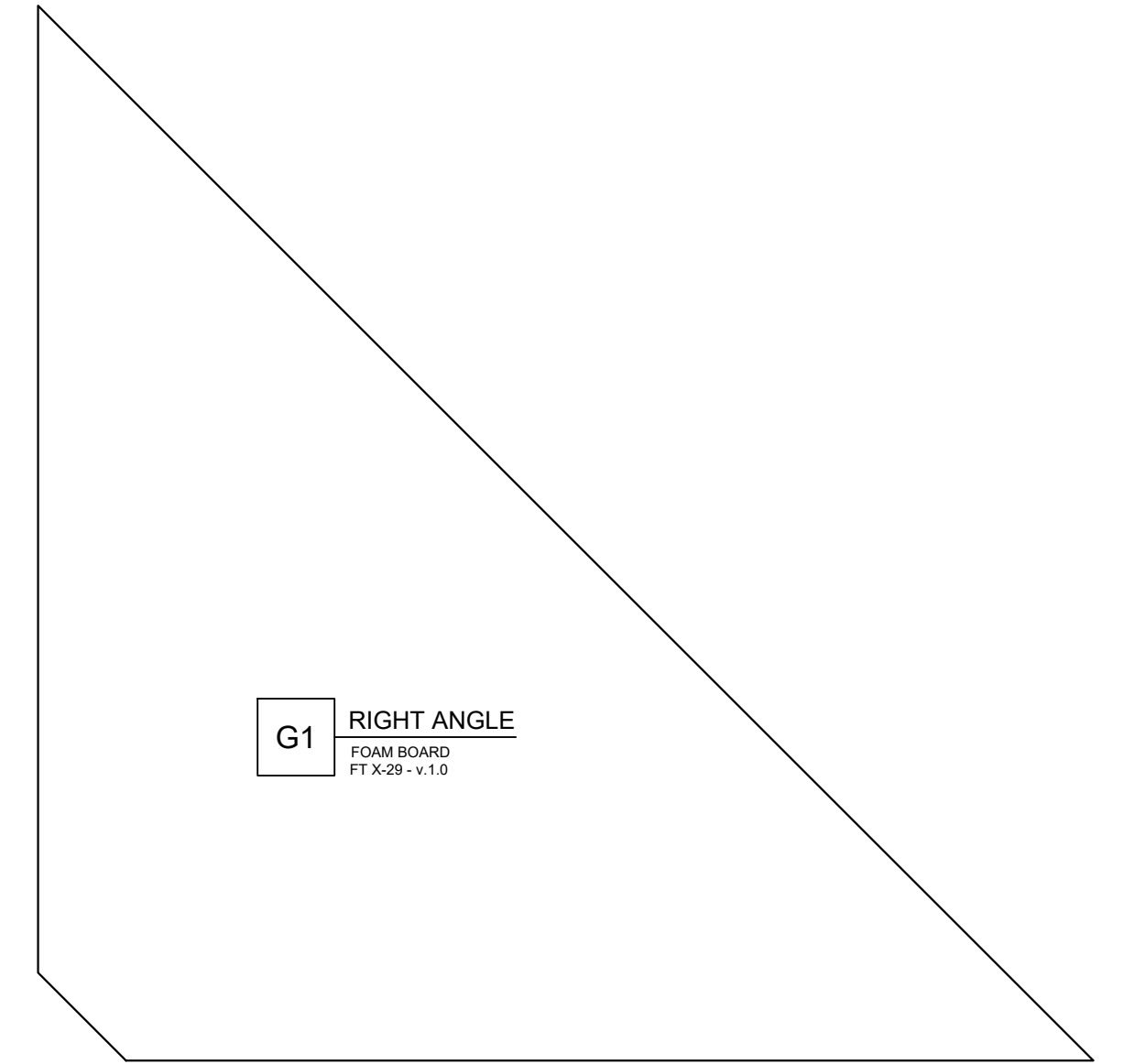

G1 RIGHT ANGLE
FOAM BOARD
FT X-29 - v.1.0

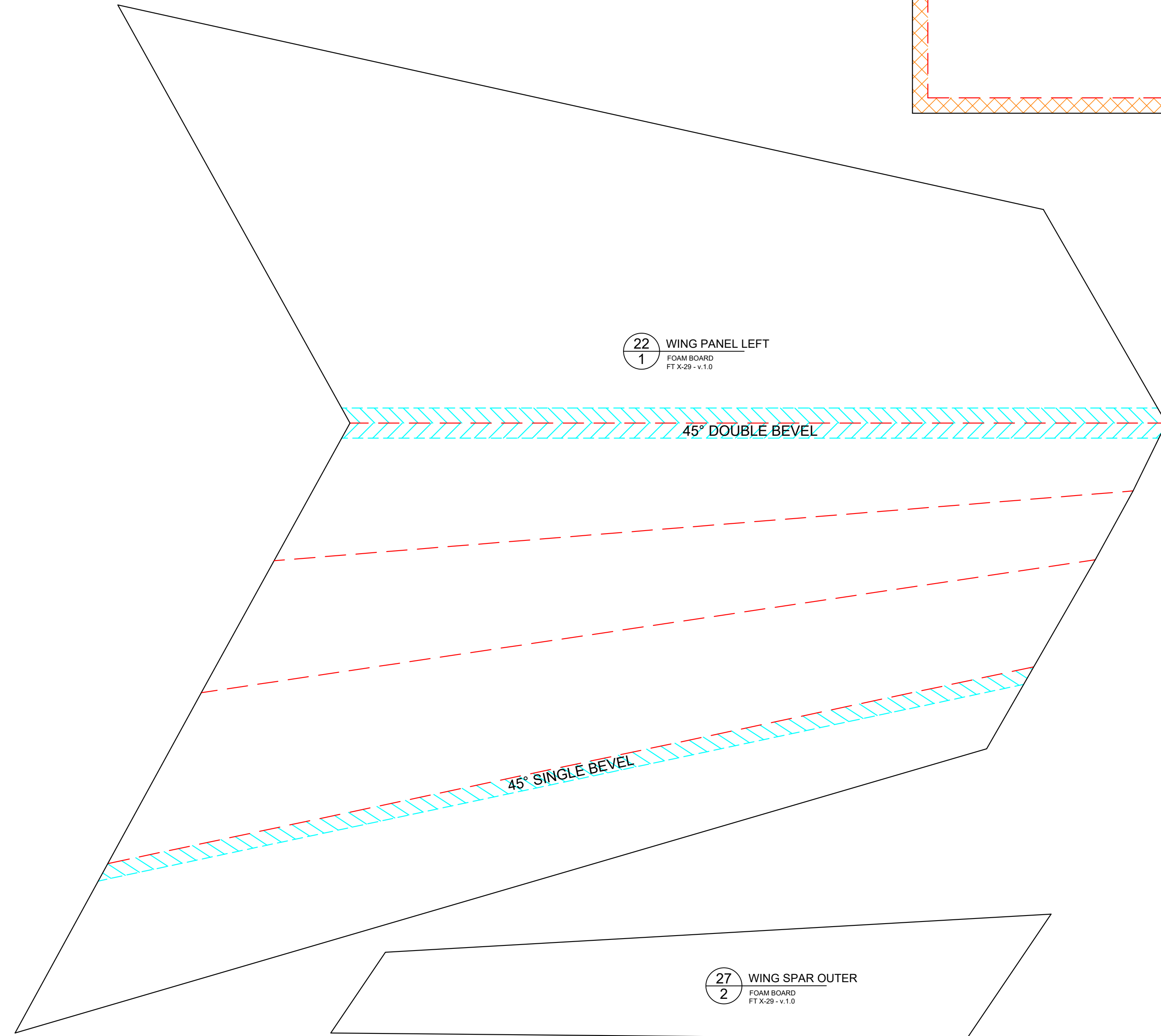

22 WING PANEL LEFT
1
FOAM BOARD
FT X-29 - v.1.0

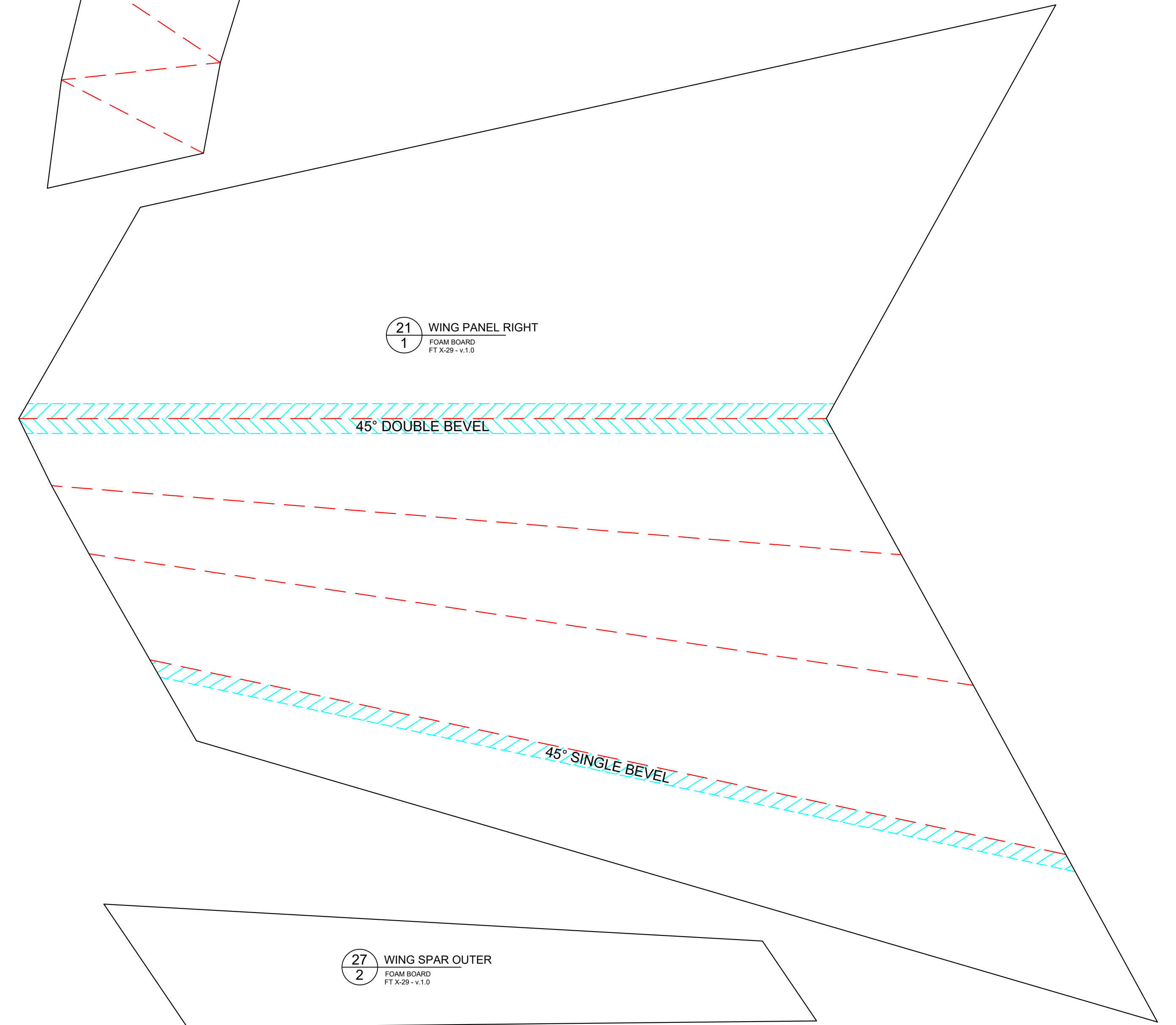

21 WING PANEL RIGHT
1
FOAM BOARD
FT X-29 - v.1.0

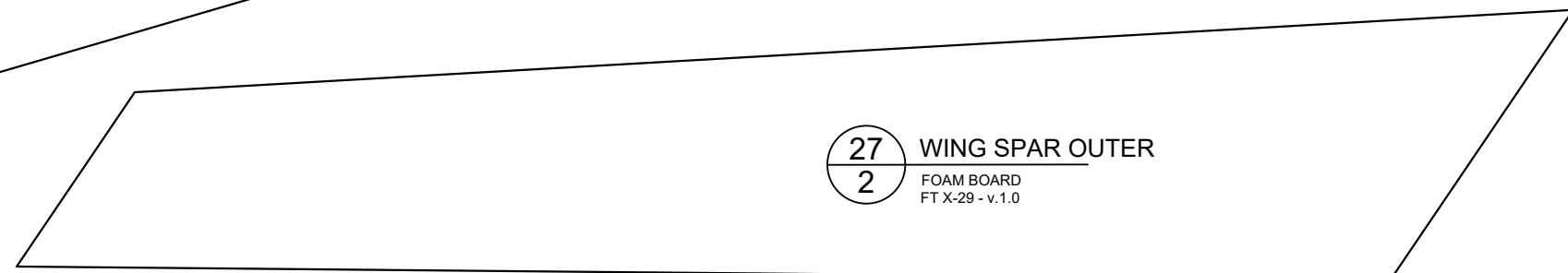

27 WING SPAR OUTER
2
FOAM BOARD
FT X-29 - v.1.0

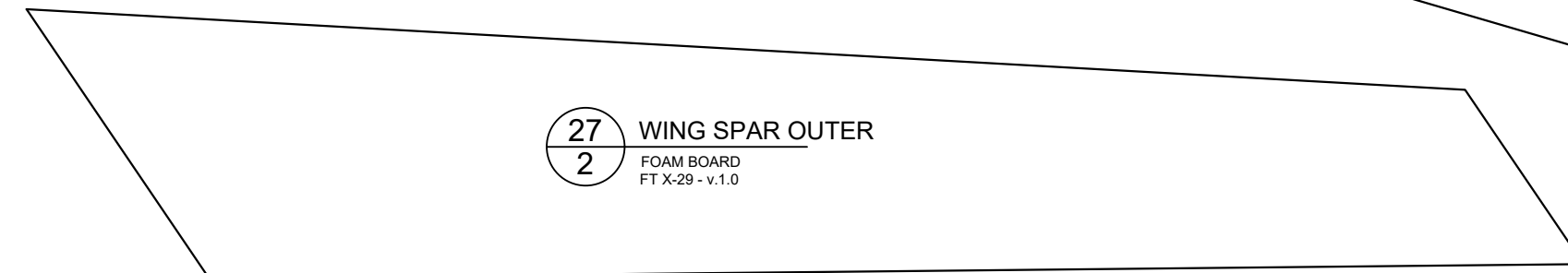

27 WING SPAR OUTER
2
FOAM BOARD
FT X-29 - v.1.0

FT X-29

Designed By: Andres Lu
Drawing By: Dan Sponholz
Version: 1.0
Date: 2017.09.20

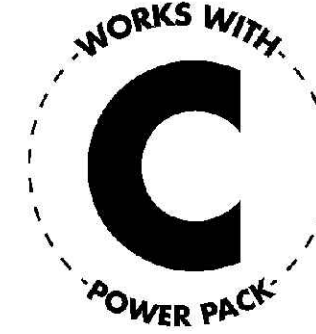

www.flitetest.com

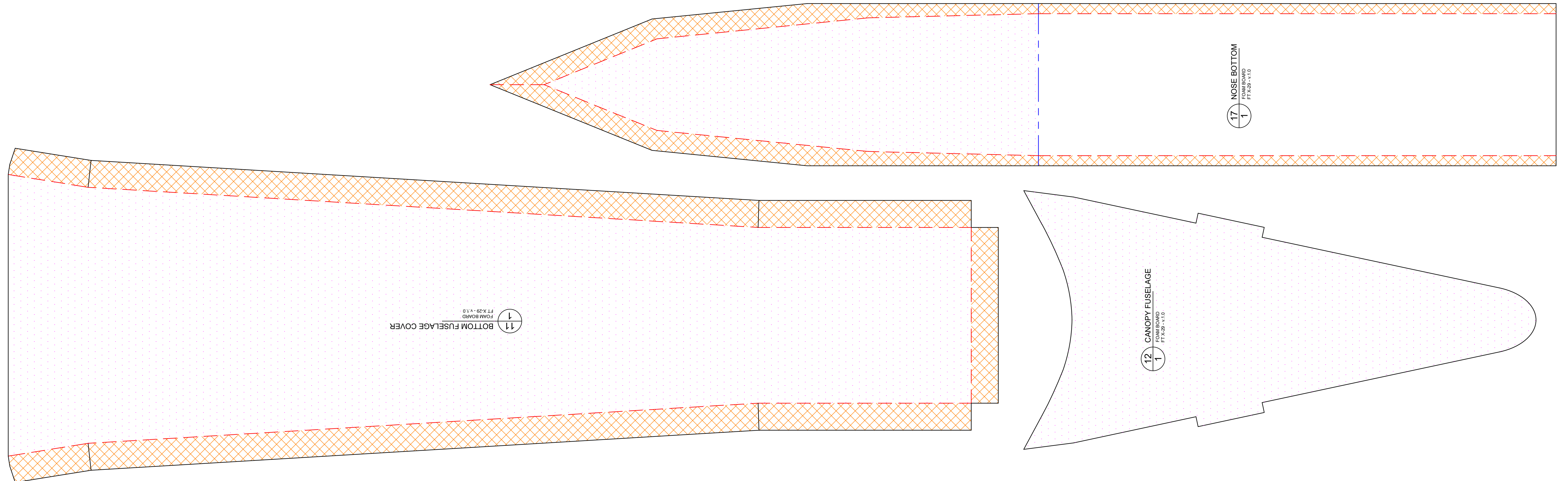
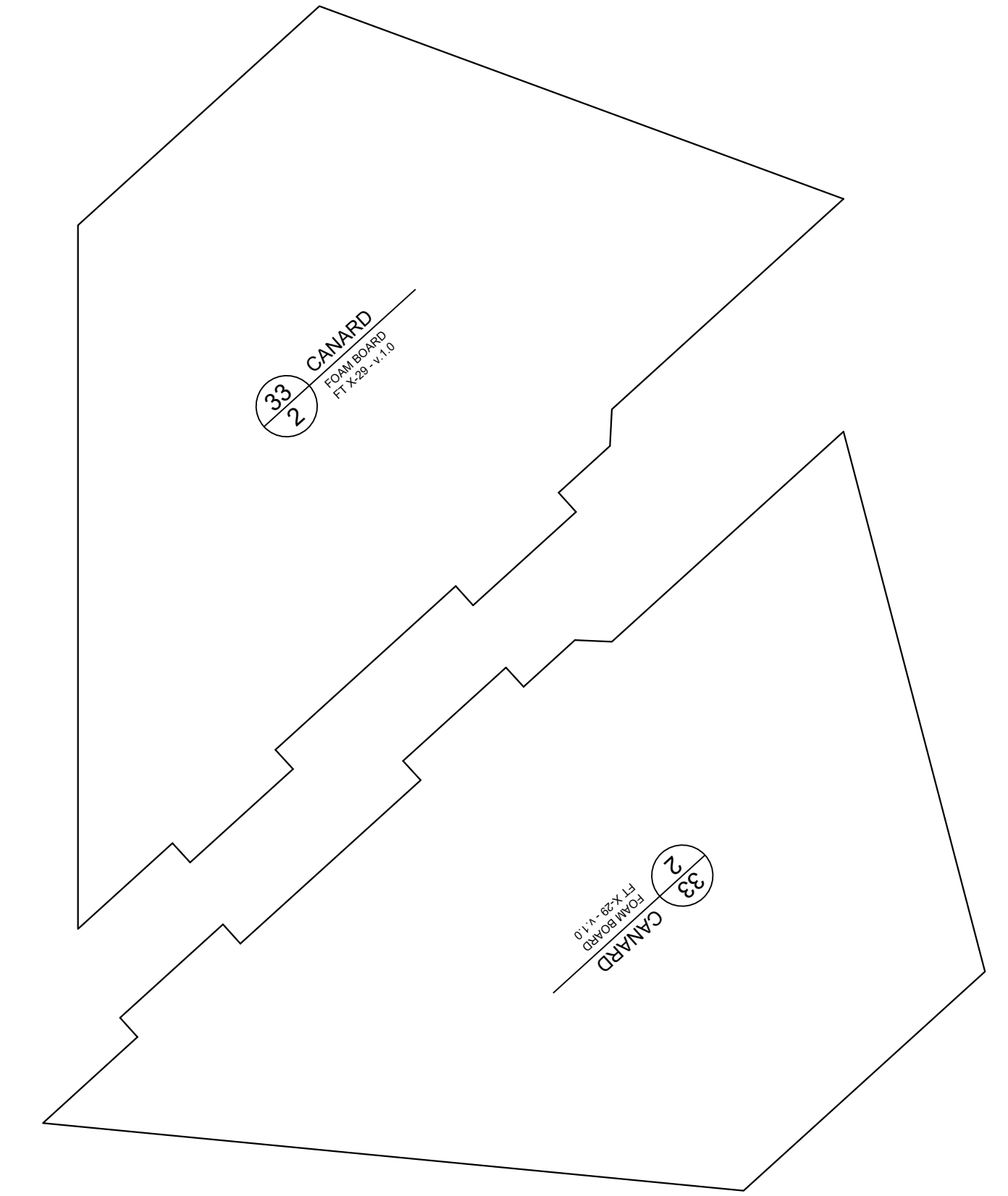
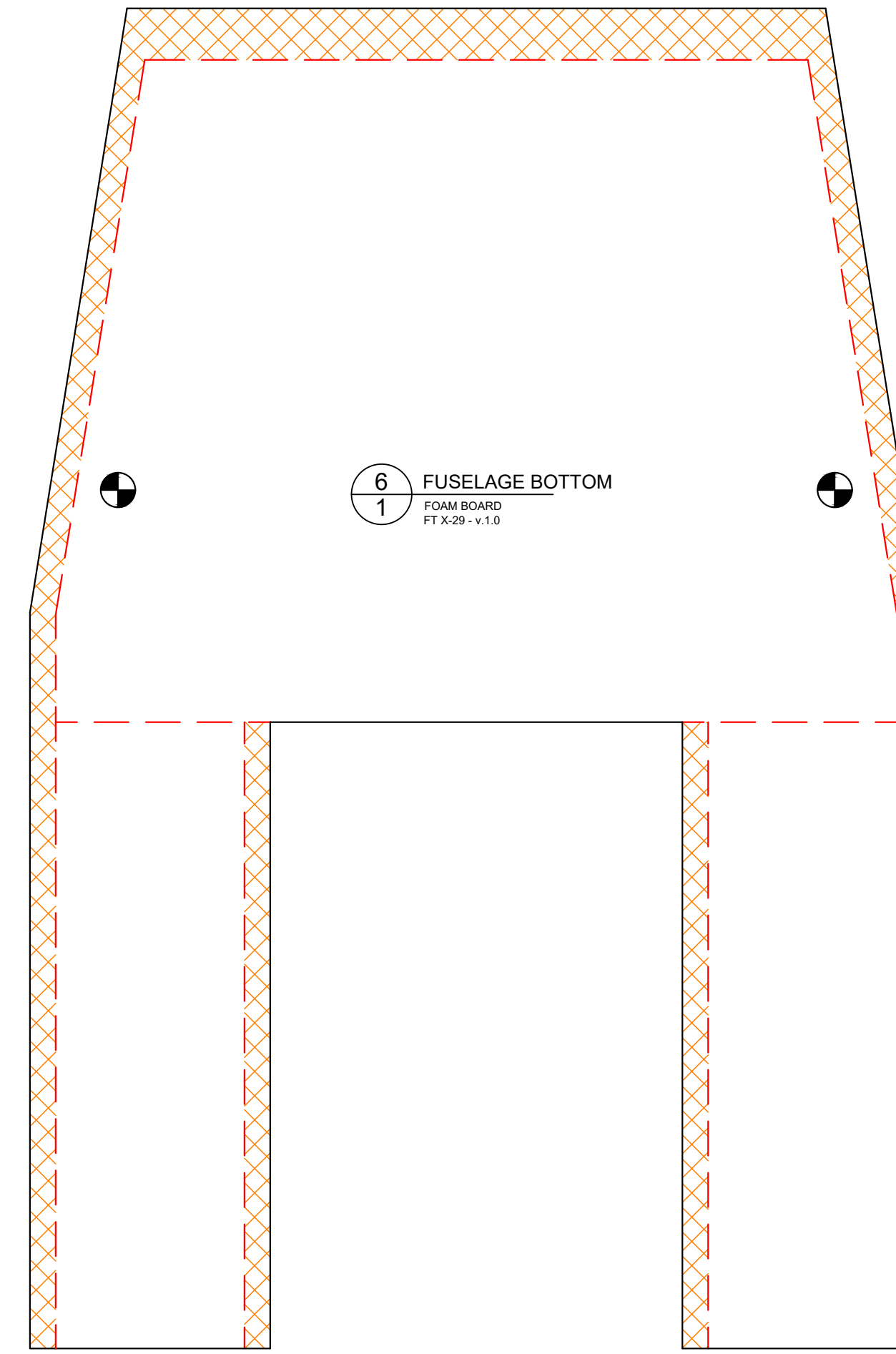
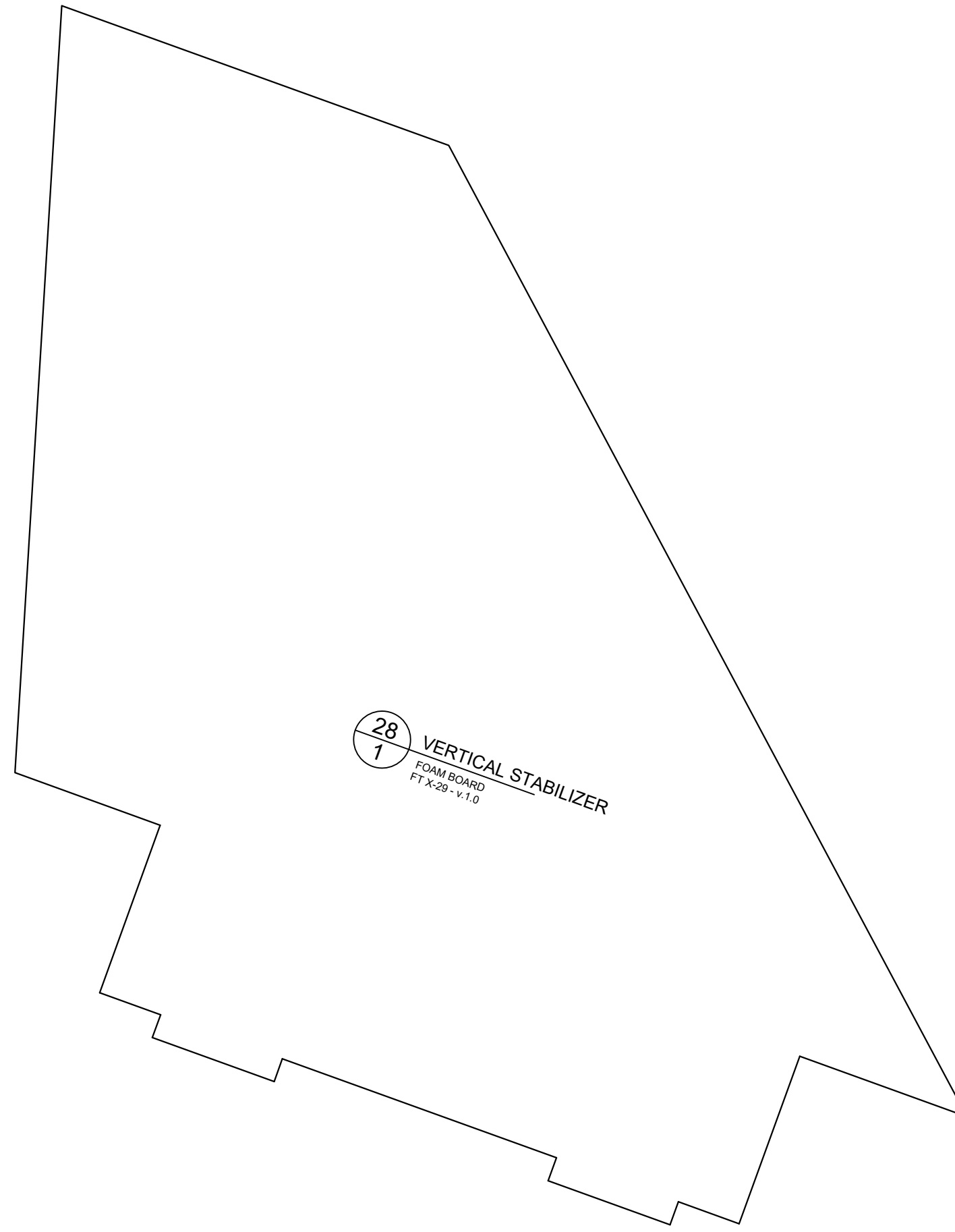
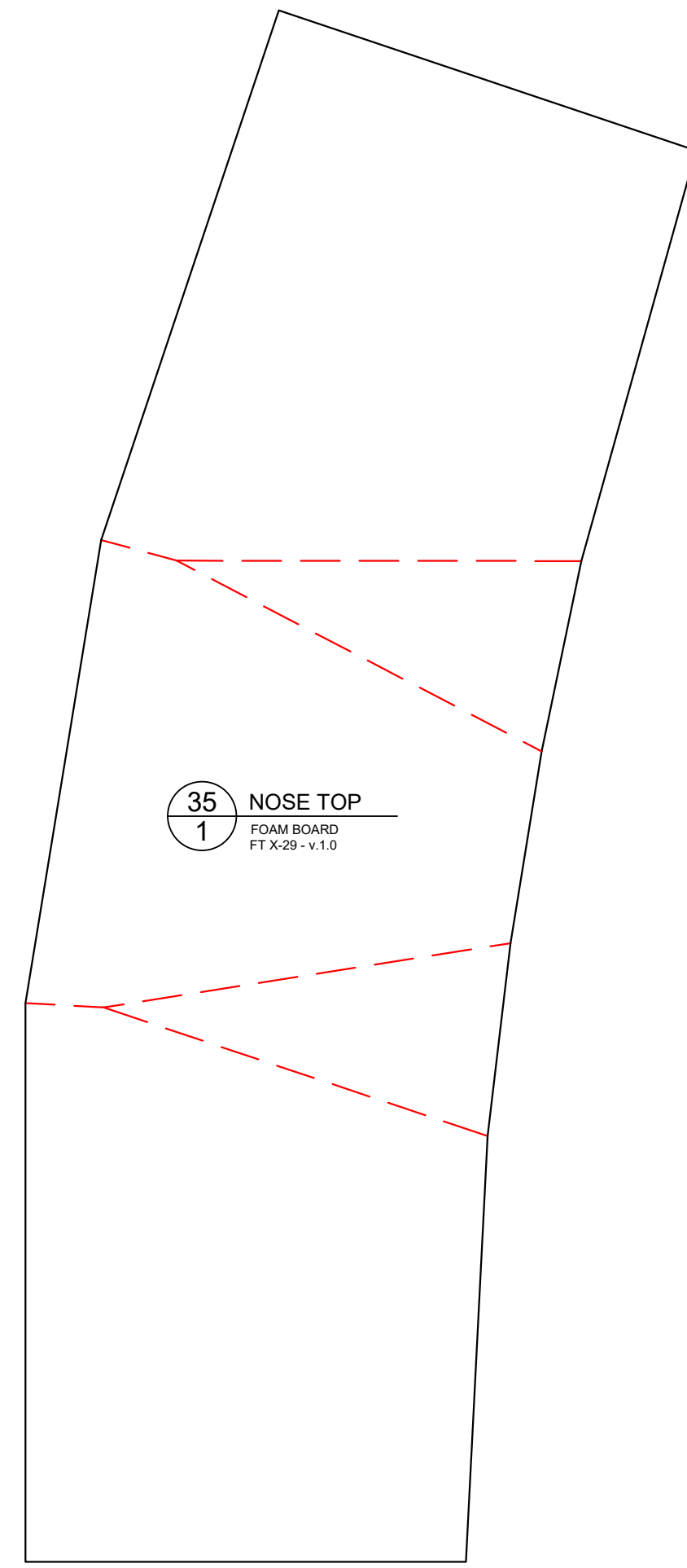

FT X-29

Designed By: Andres Lu
Drawing By: Dan Sponholz
Version: 1.0
Date: 2017.09.20



www.flitetest.com

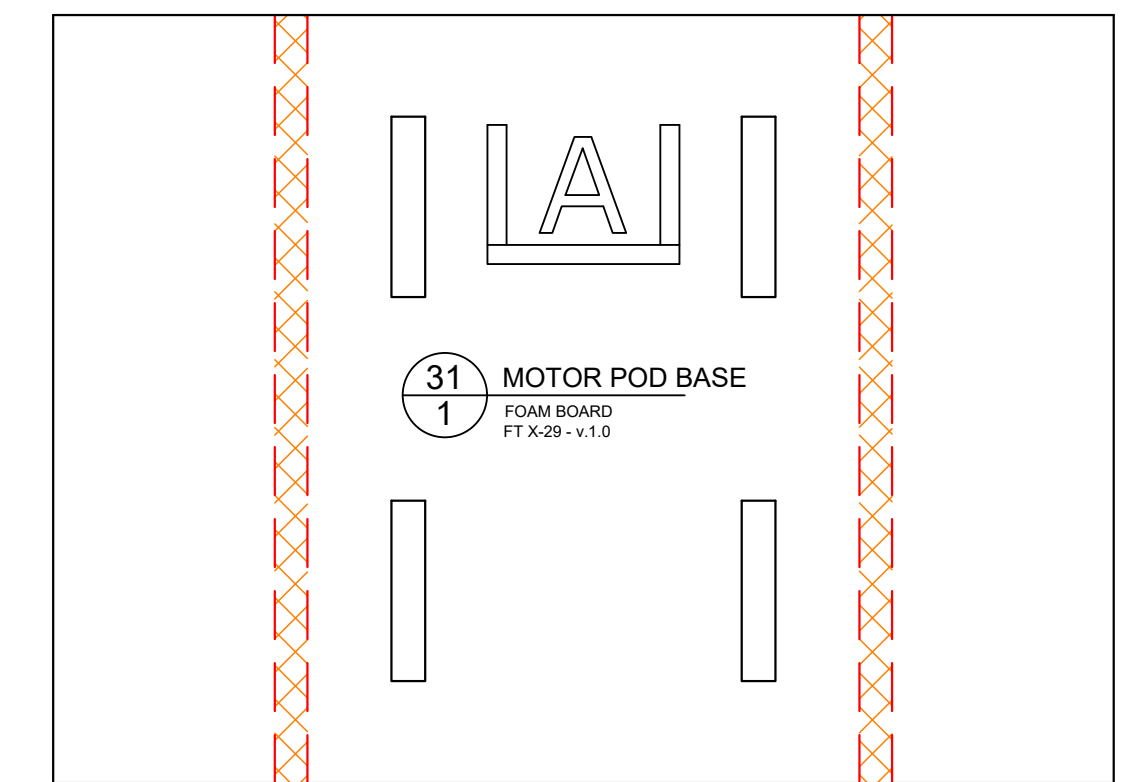
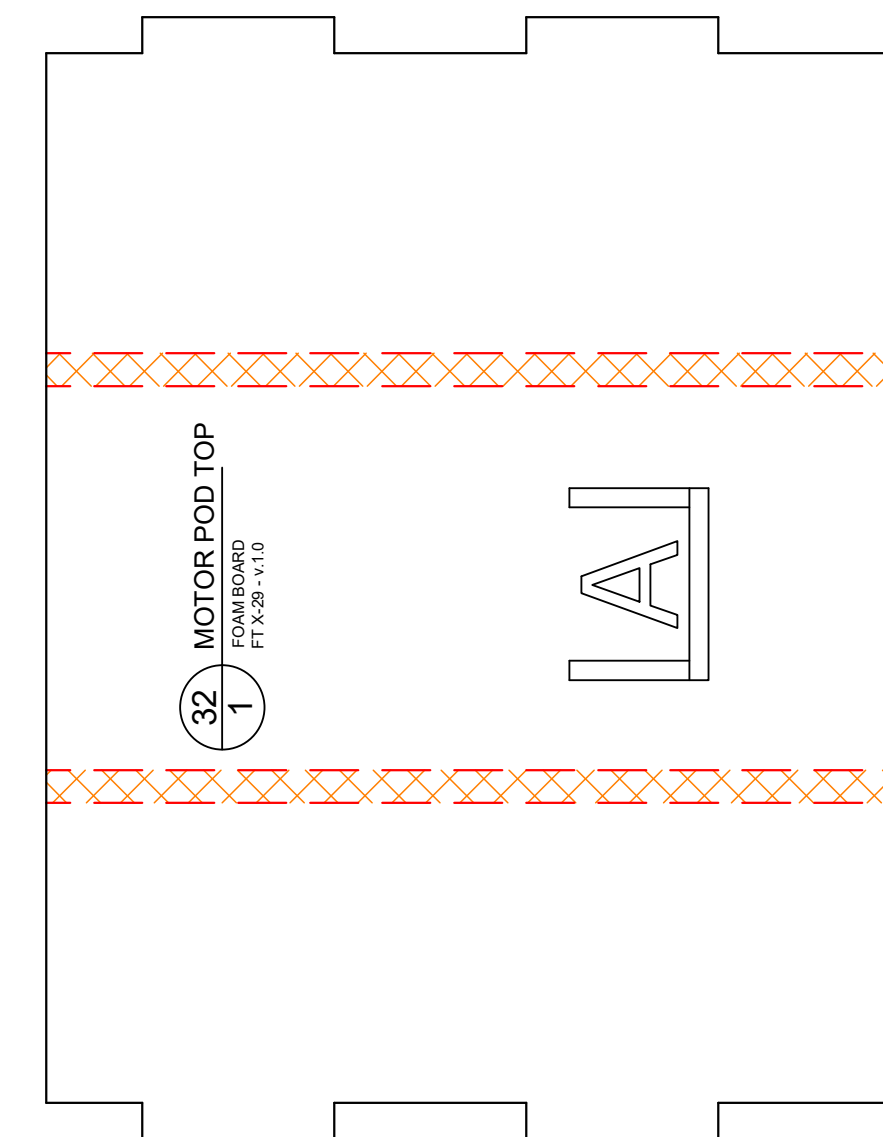
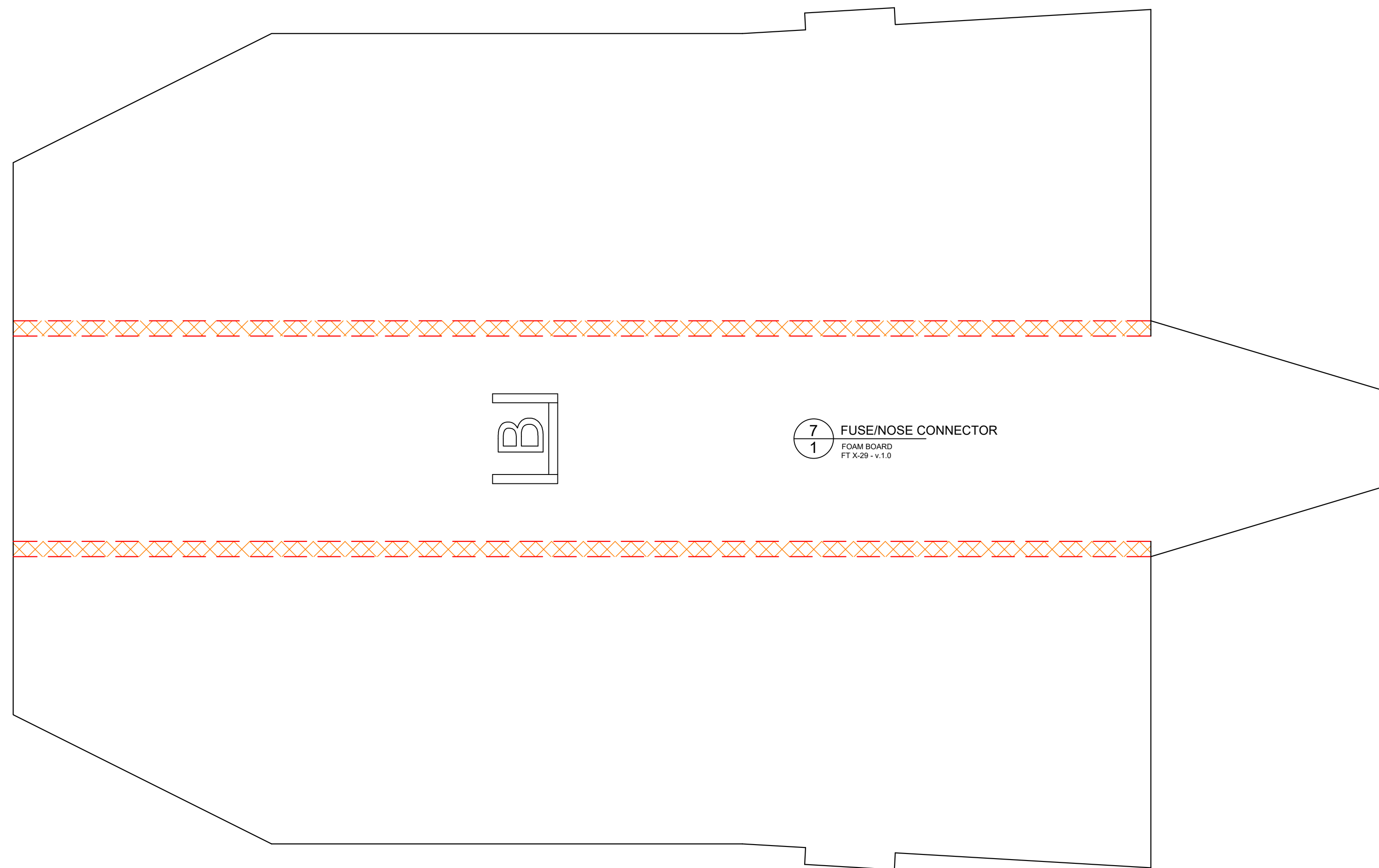
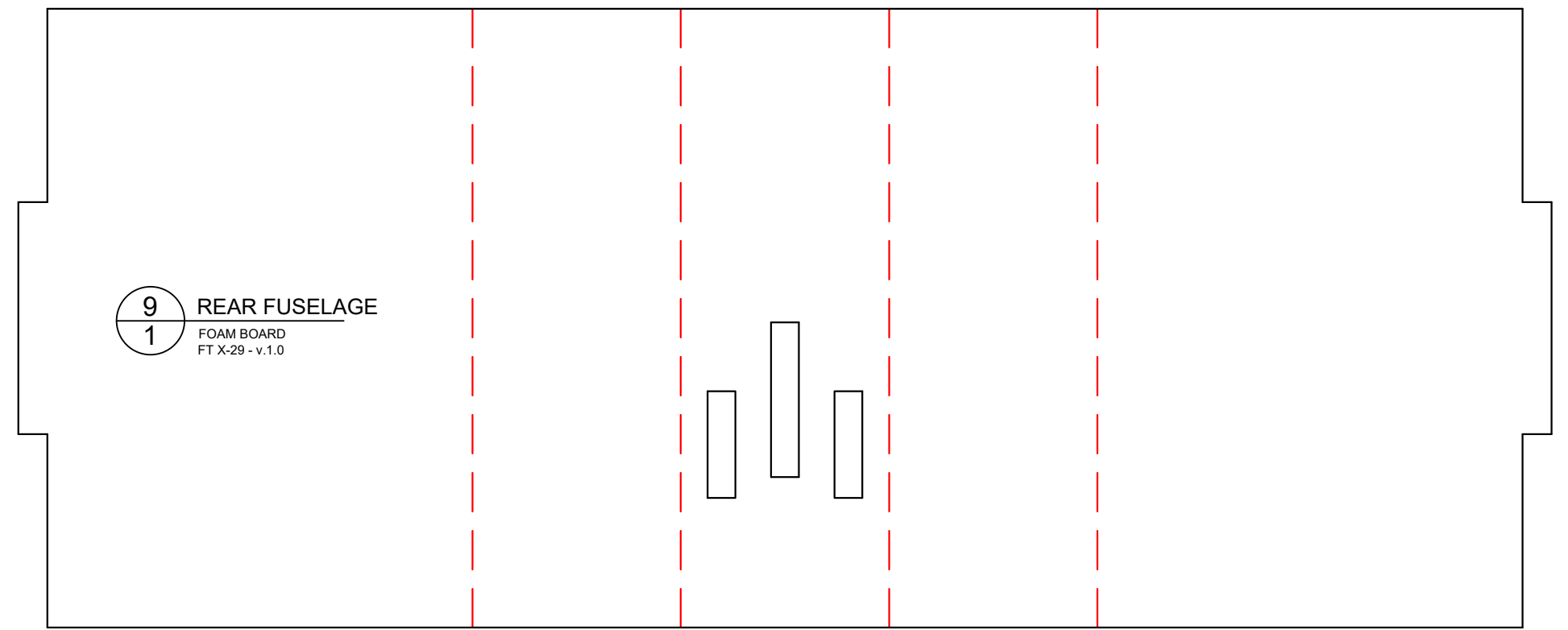
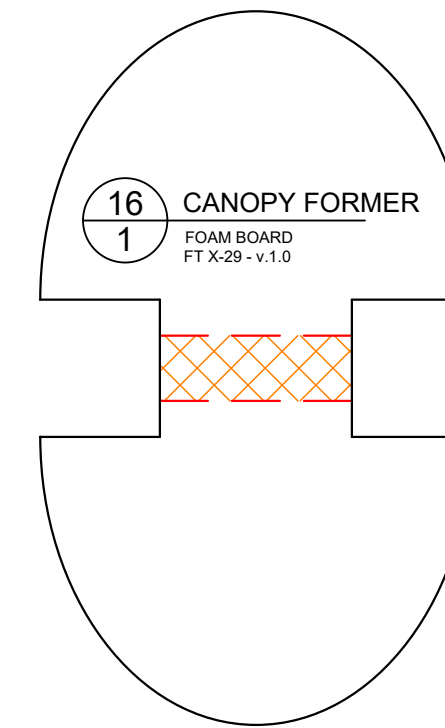
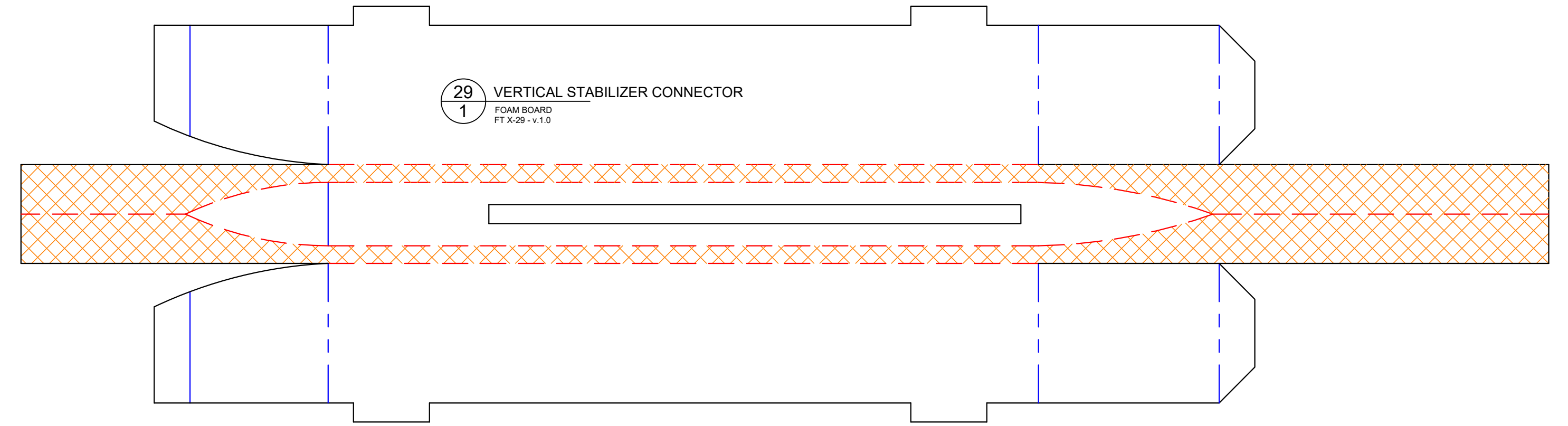
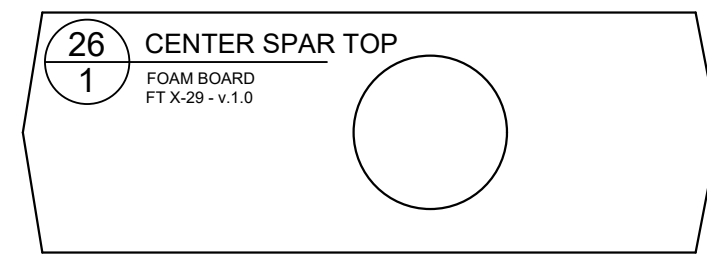
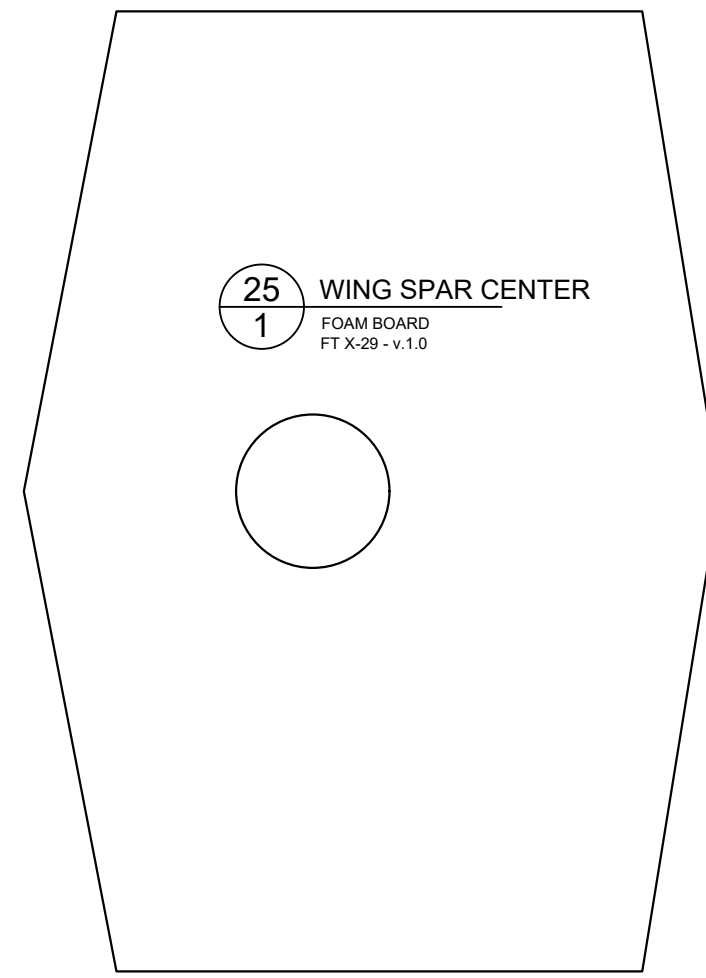
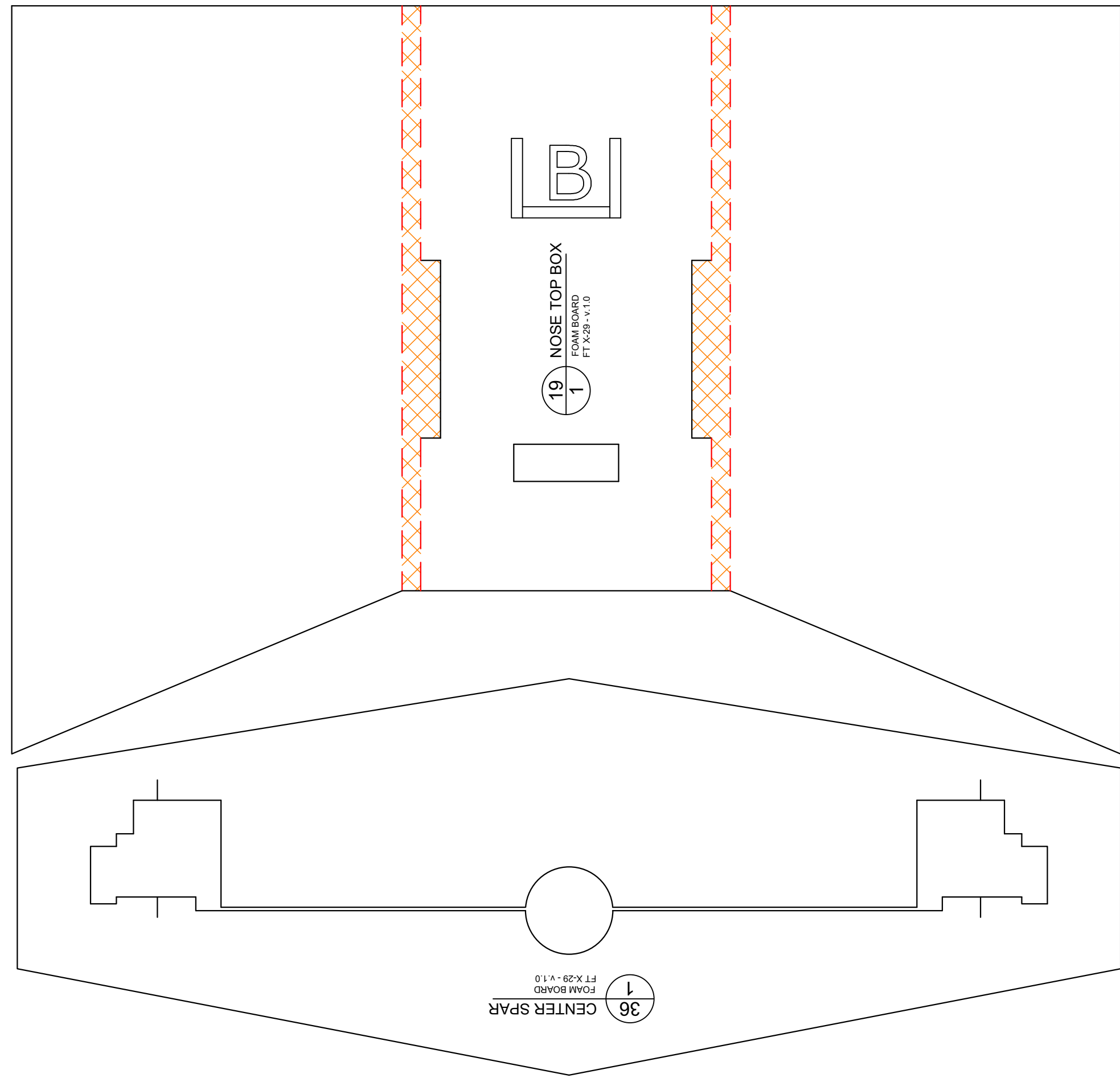

FT X-29

Designed By: Andres Lu
Drawing By: Dan Sponholz
Version: 1.0
Date: 2017.09.20

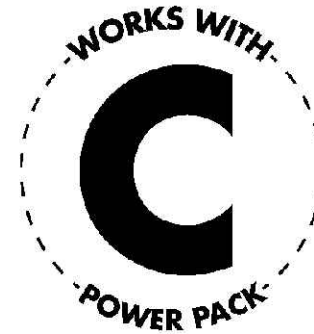

www.flitetest.com

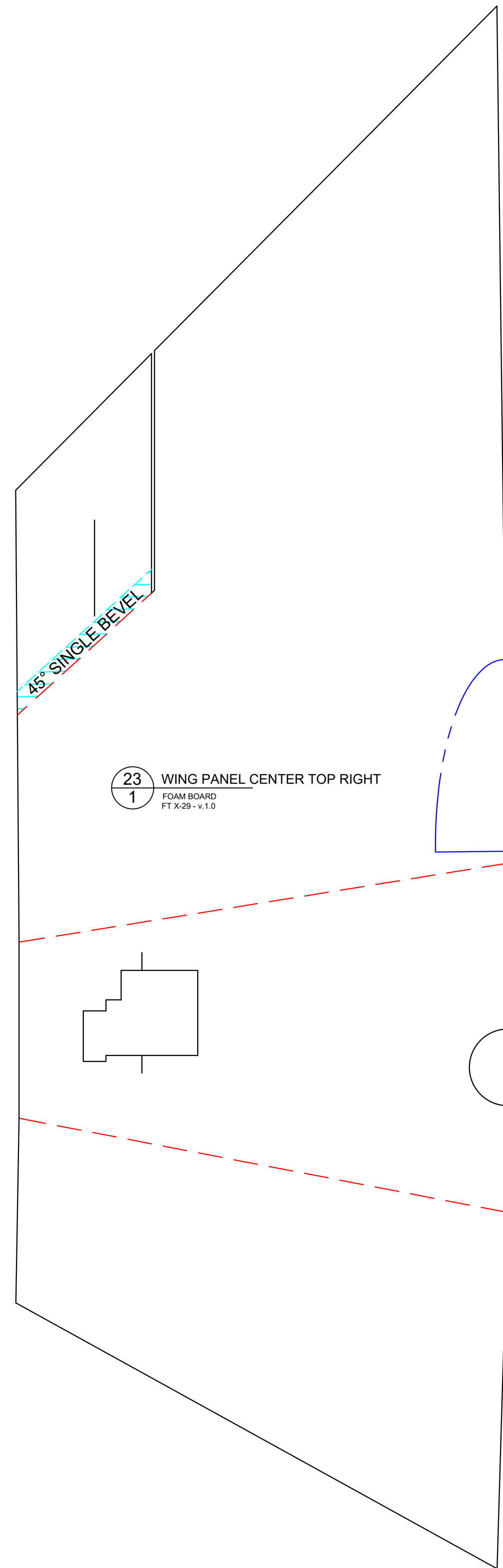

23 WING PANEL CENTER TOP RIGHT
FOAM BOARD
FT X-29 - v1.0

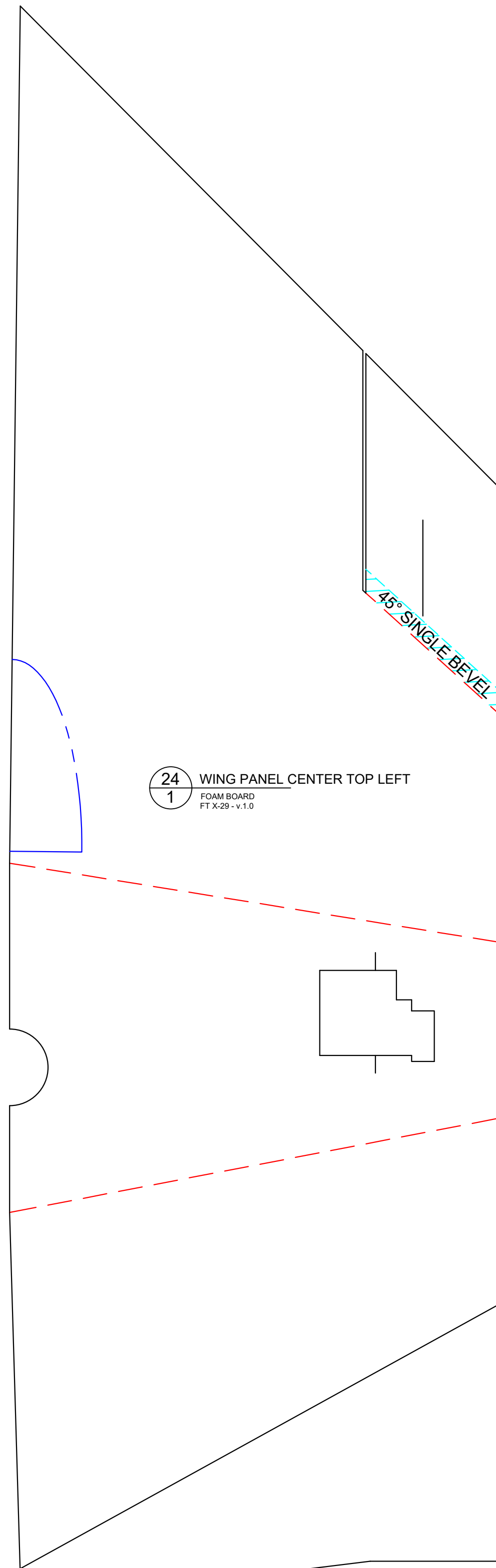

24 WING PANEL CENTER TOP LEFT
FOAM BOARD
FT X-29 - v1.0

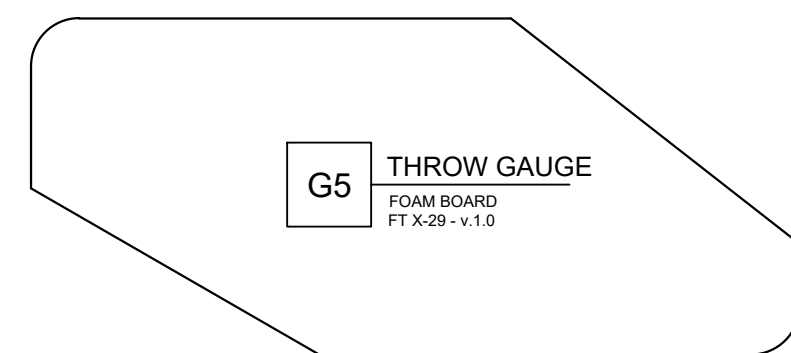

G5 THROW GAUGE
FOAM BOARD
FT X-29 - v1.0

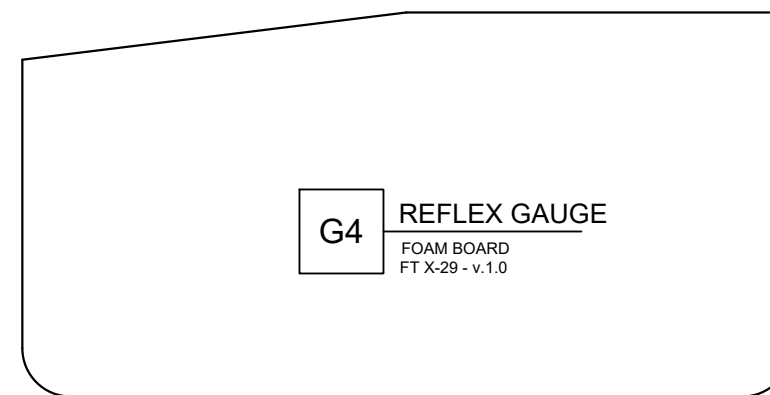

G4 REFLEX GAUGE
FOAM BOARD
FT X-29 - v1.0

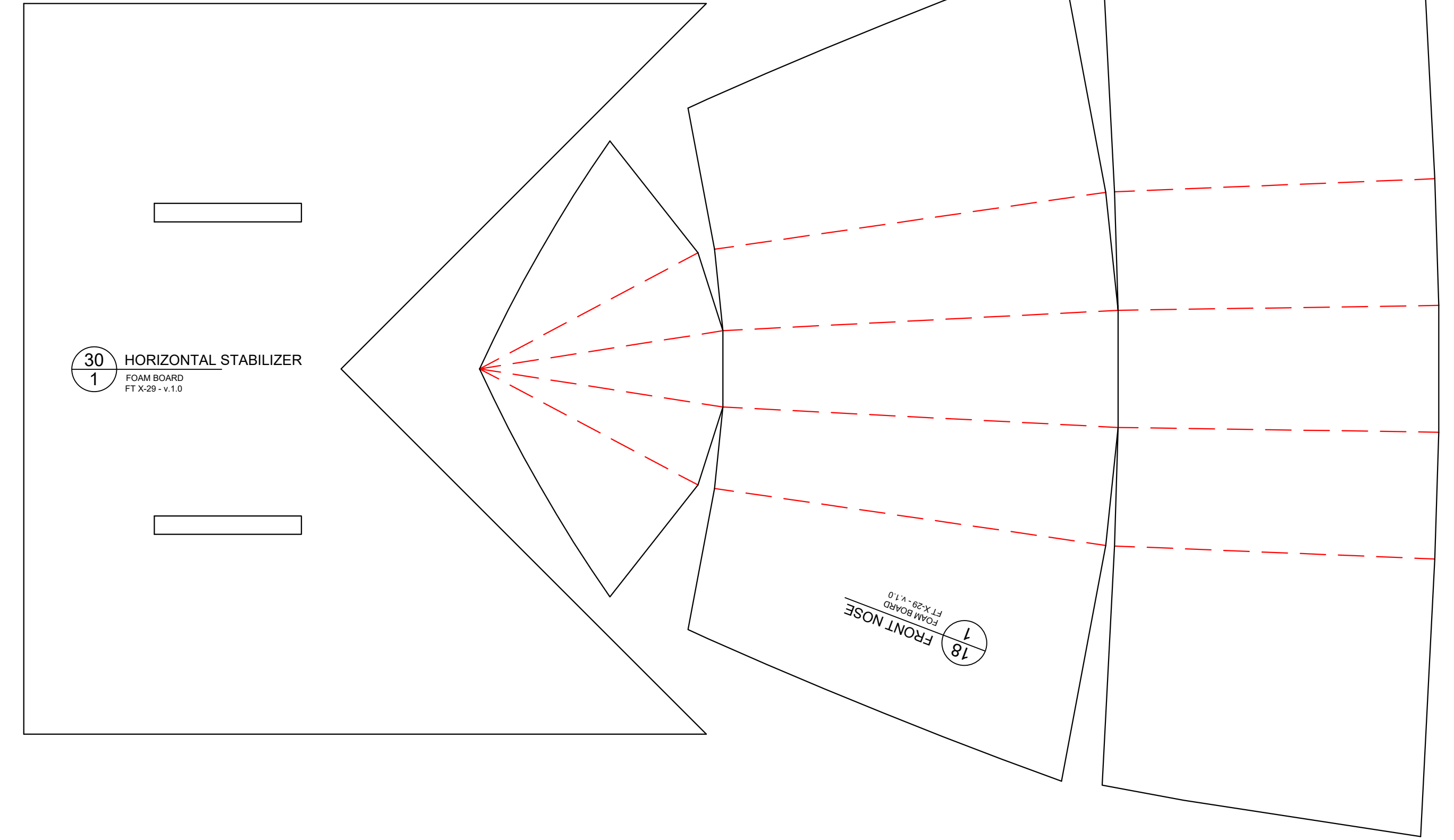

30 HORIZONTAL STABILIZER
FOAM BOARD
FT X-29 - v1.0

18 FRONT NOSE
FOAM BOARD
FT X-29 - v1.0

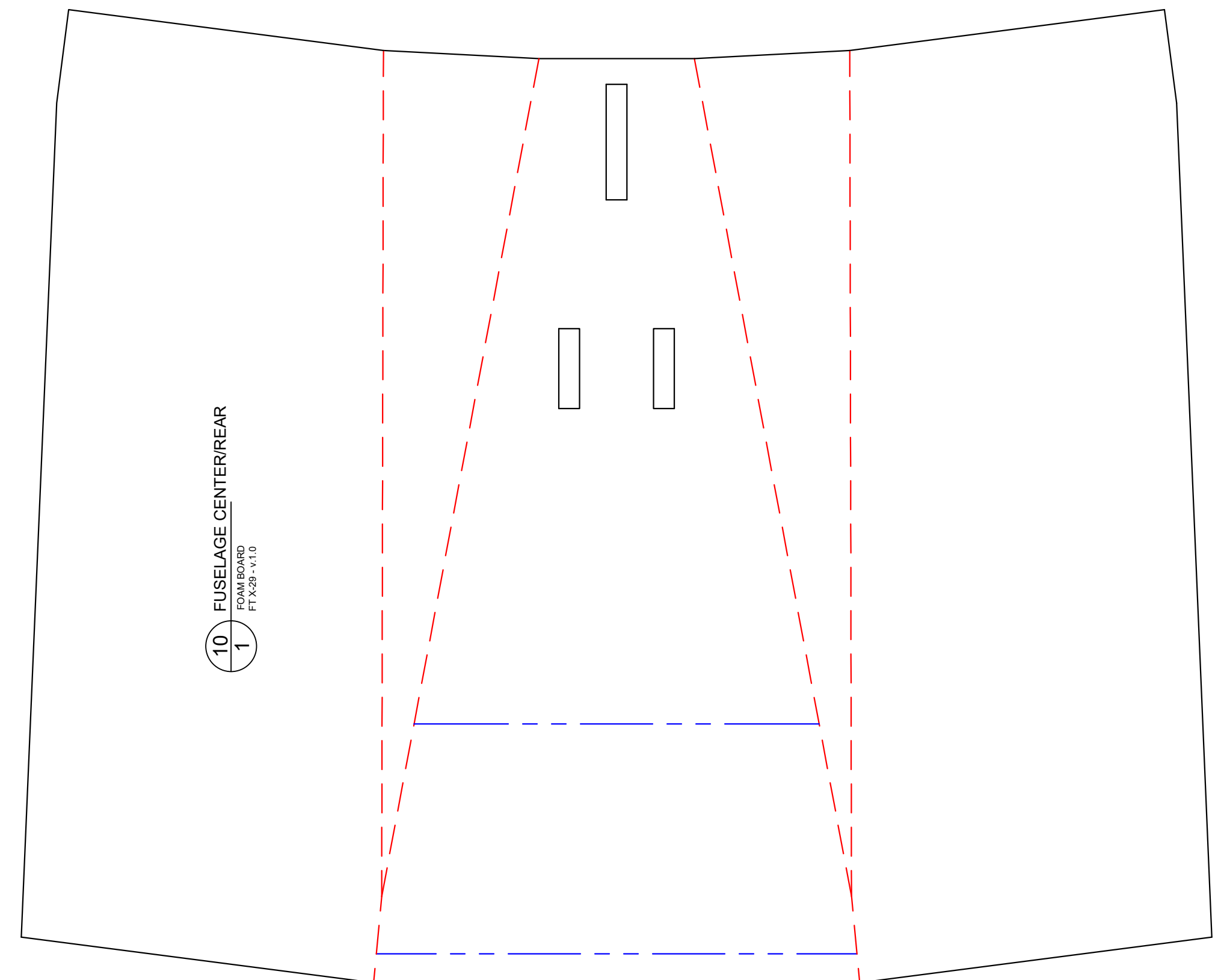

10 FUSELAGE CENTER REAR
FOAM BOARD
FT X-29 - v1.0

FT X-29

Designed By: Andres Lu
Drawing By: Dan Sponholz
Version: 1.0
Date: 2017.09.20



www.flitetest.com

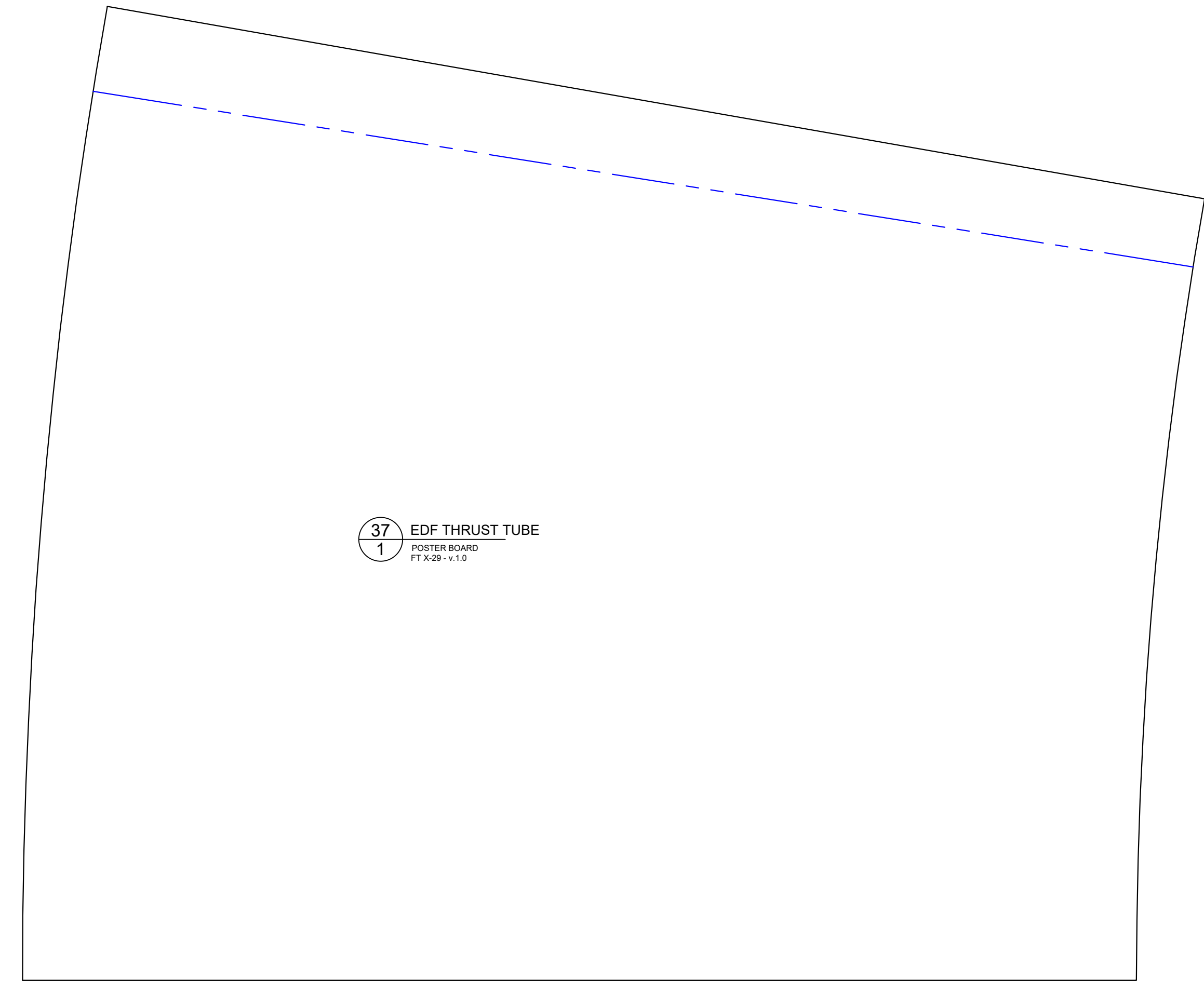
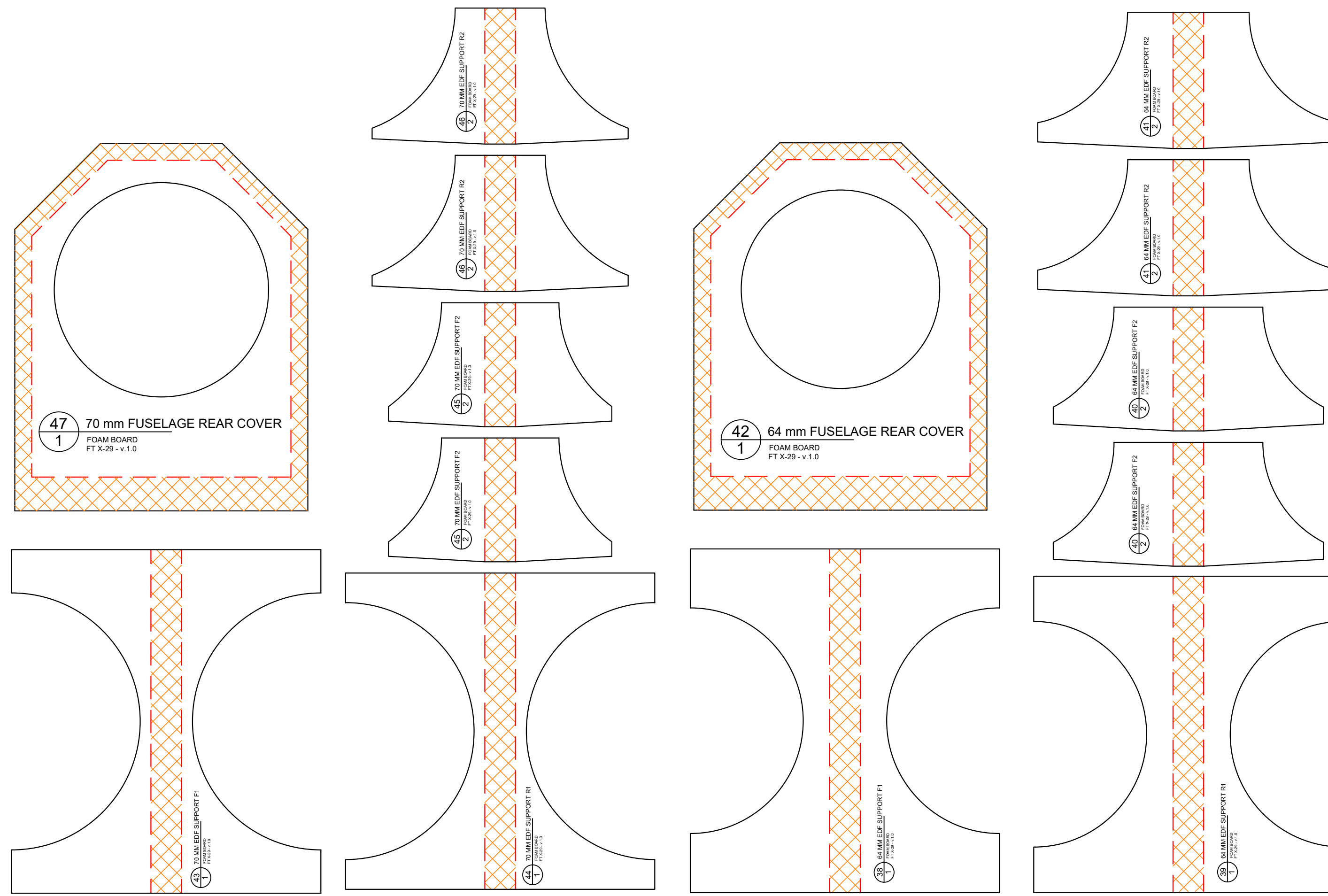



IN
CM

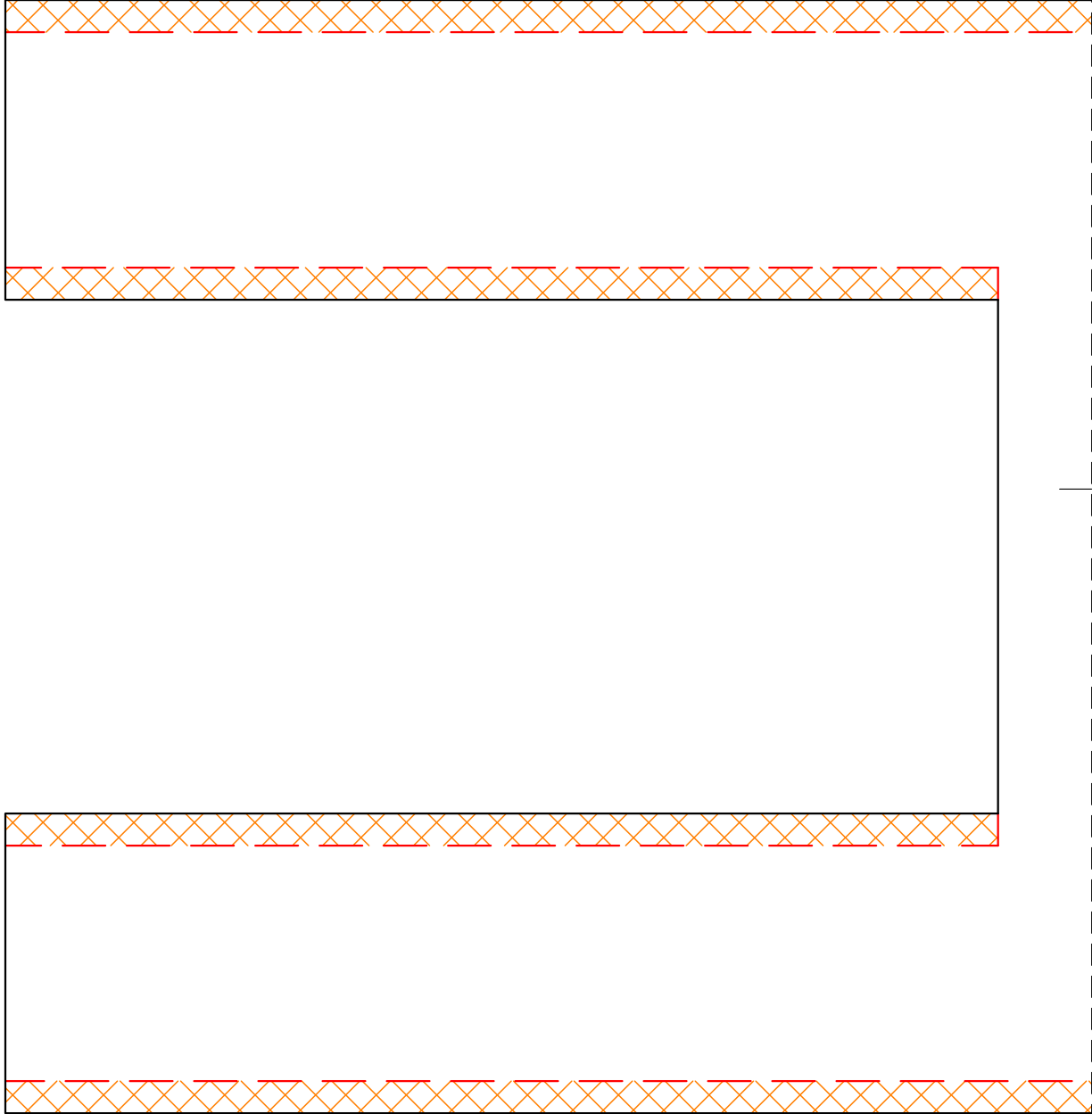

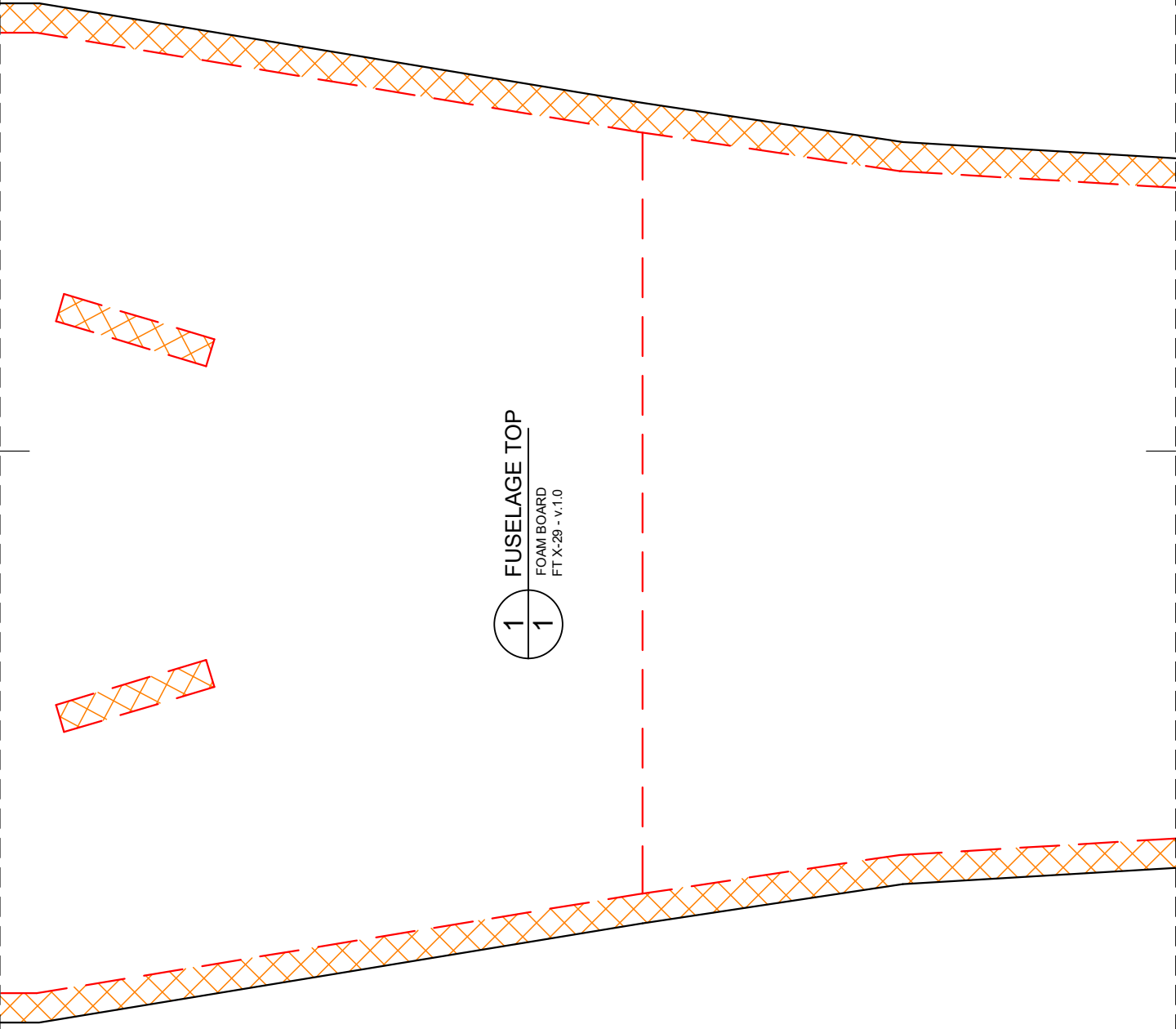

1 FUSELAGE TOP
1 FOAM BOARD
FT X-29 - v.1.0



IN
CM

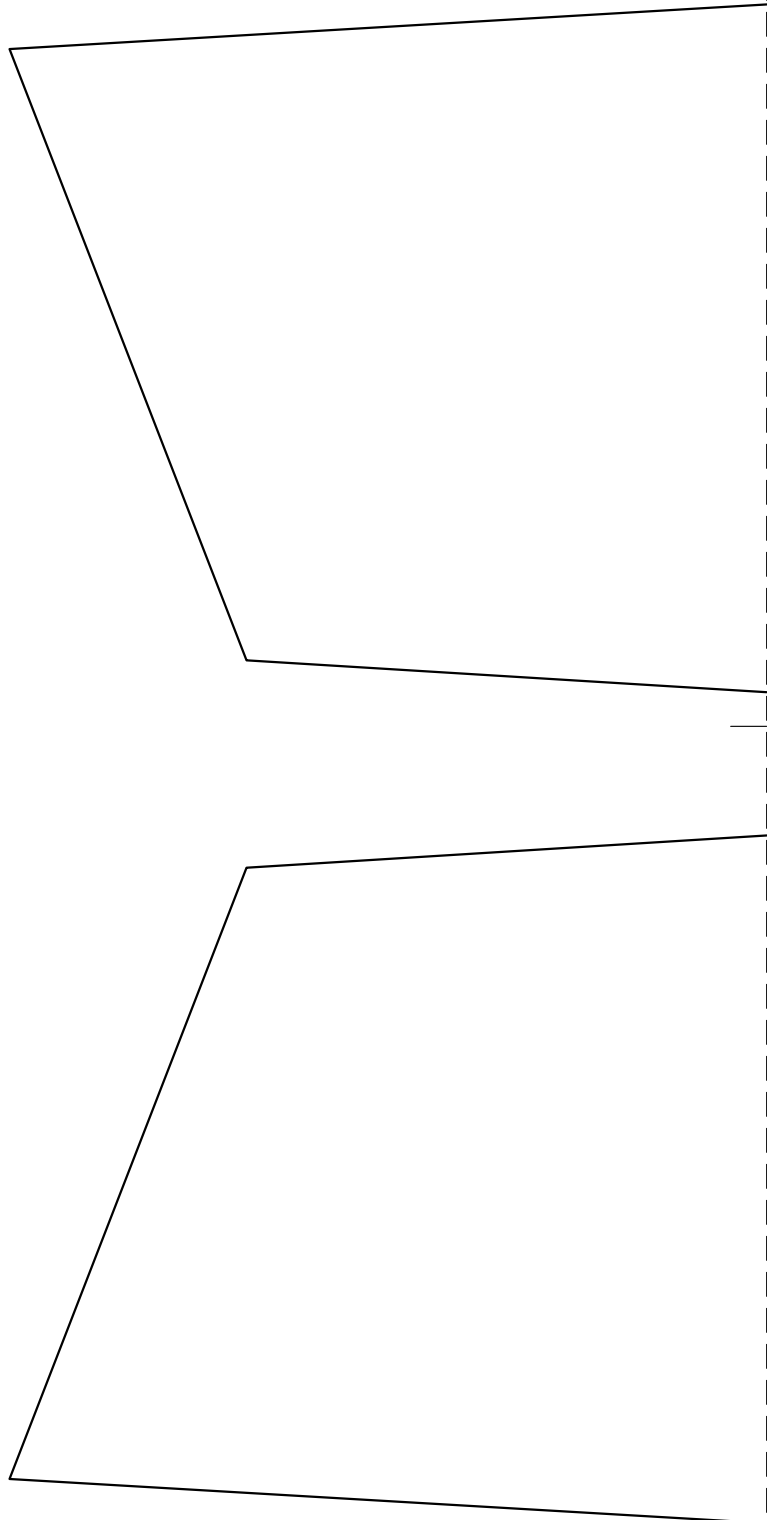
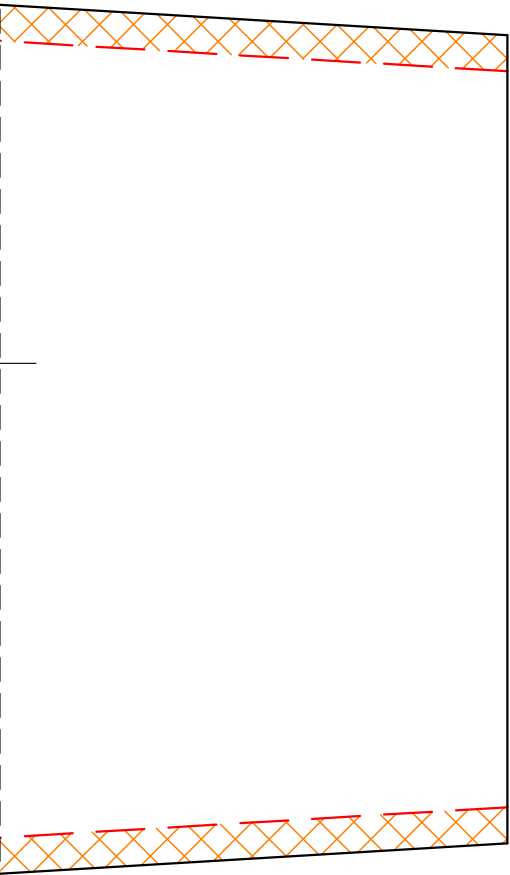

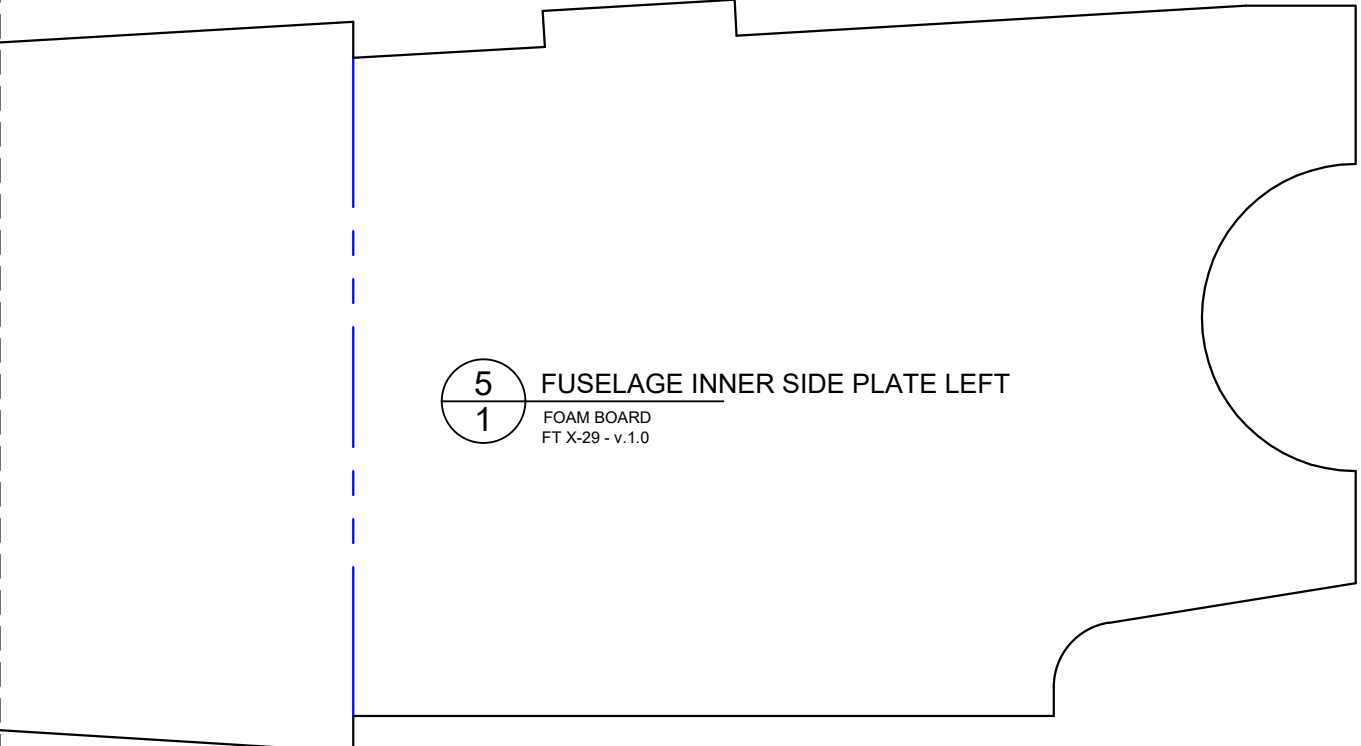

5
1

FUSELAGE INNER SIDE PLATE LEFT

FOAM BOARD
FT X-29 - v.1.0

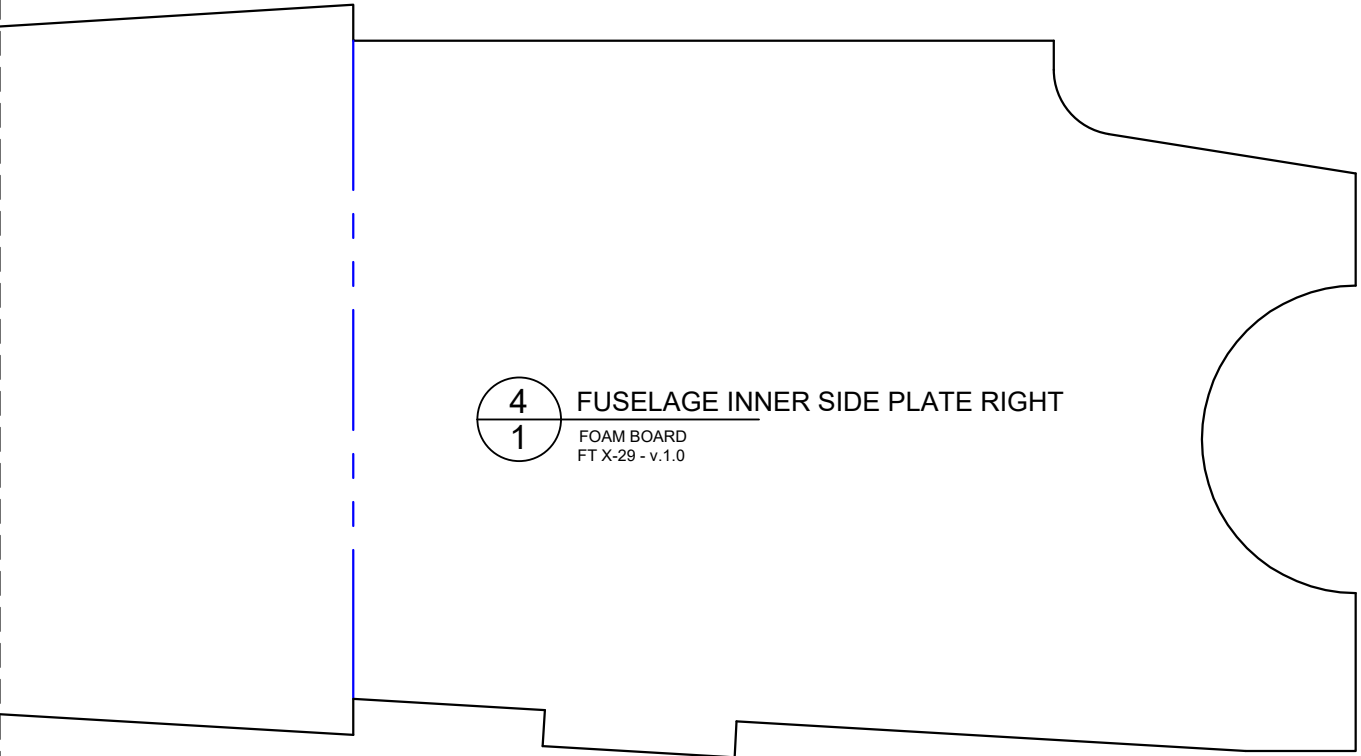

4
1

FUSELAGE INNER SIDE PLATE RIGHT

FOAM BOARD
FT X-29 - v.1.0

20
1

CENTER WING BOTTOM PLATE

FOAM BOARD
FT X-29 - v.1.0





IN
CM



2 FUSELAGE OUTER SIDE PLATE RIGHT
1 FOAM BOARD
FT X-29 - v.1.0

3 FUSELAGE OUTER SIDE PLATE LEFT
1 FOAM BOARD
FT X-29 - v.1.0

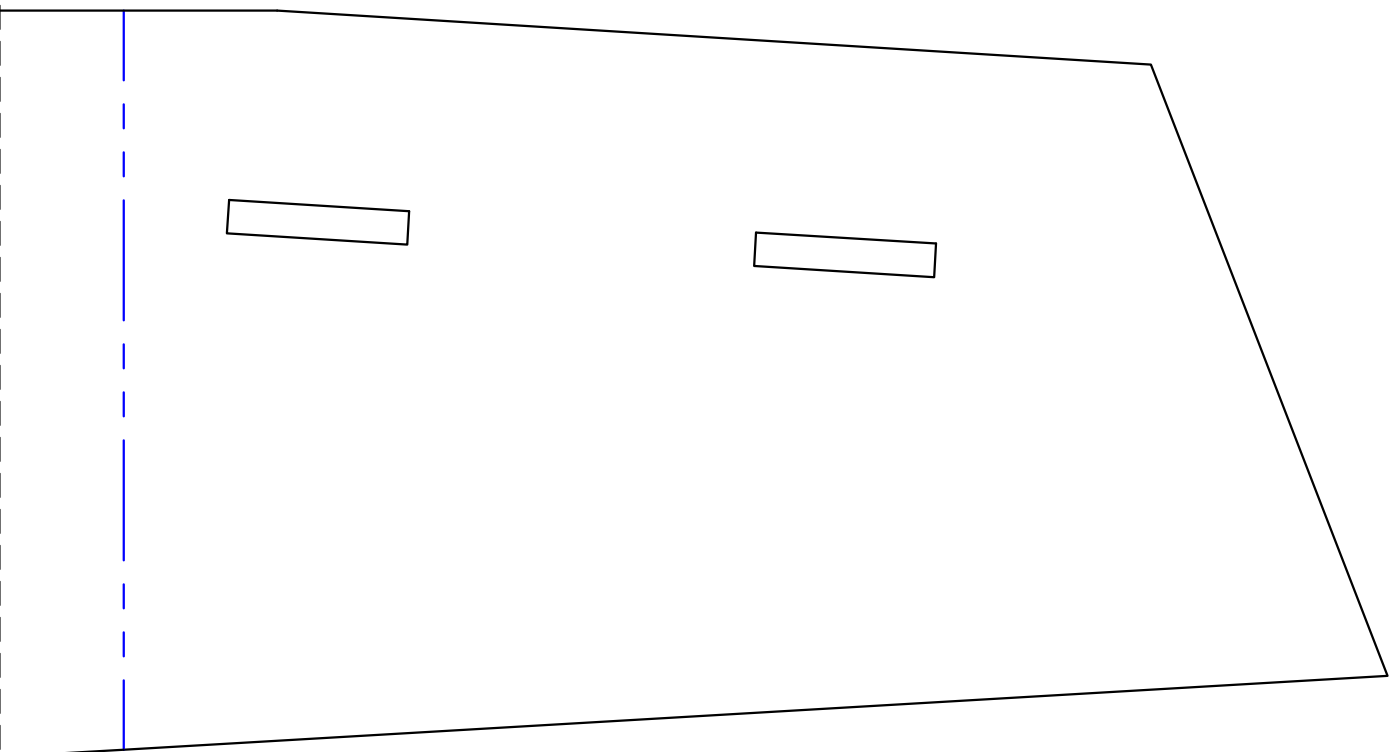
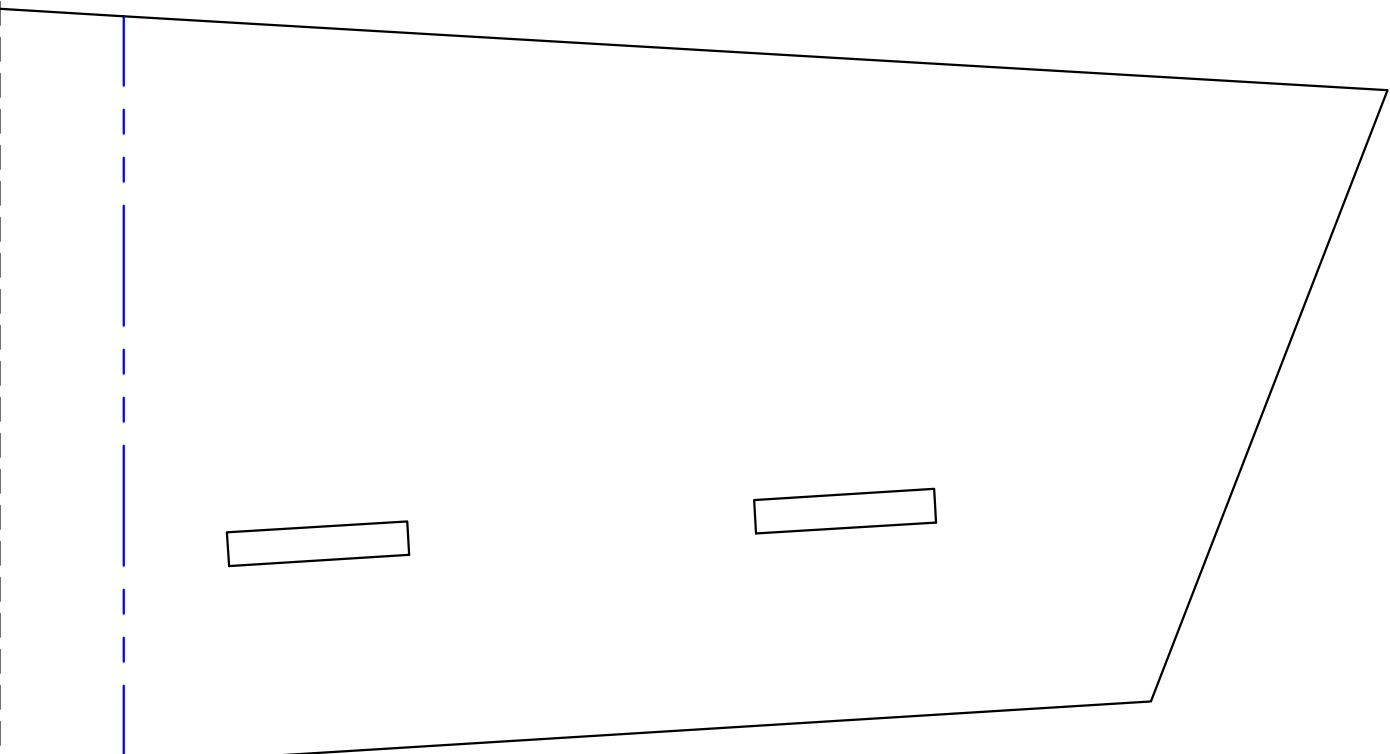

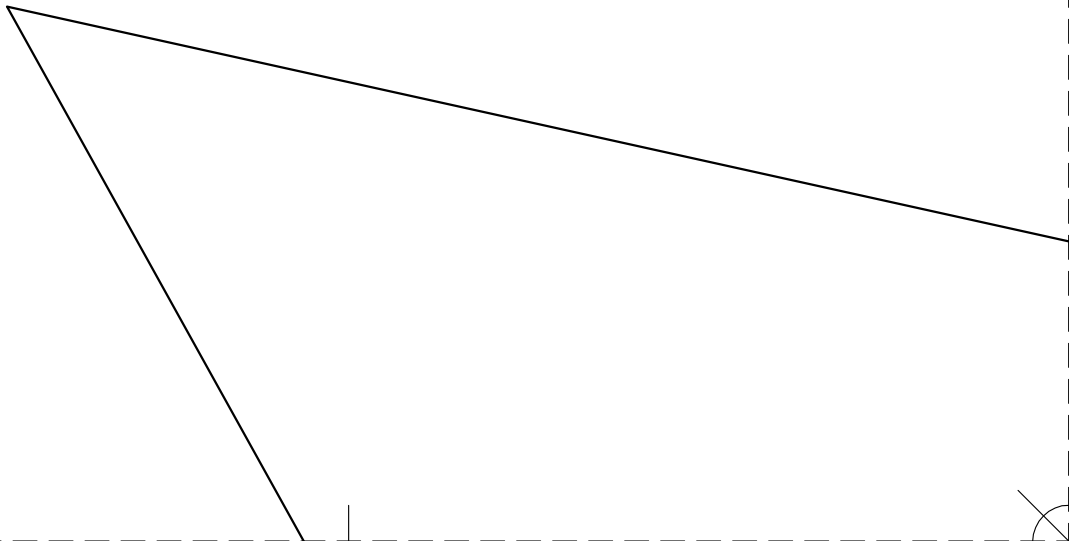
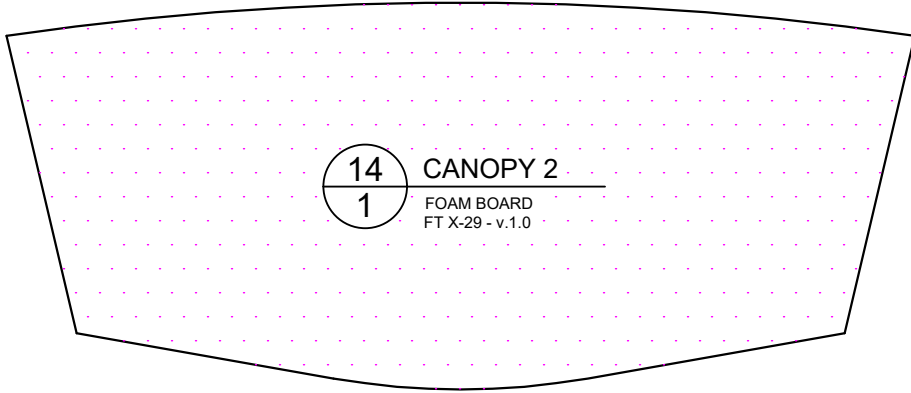
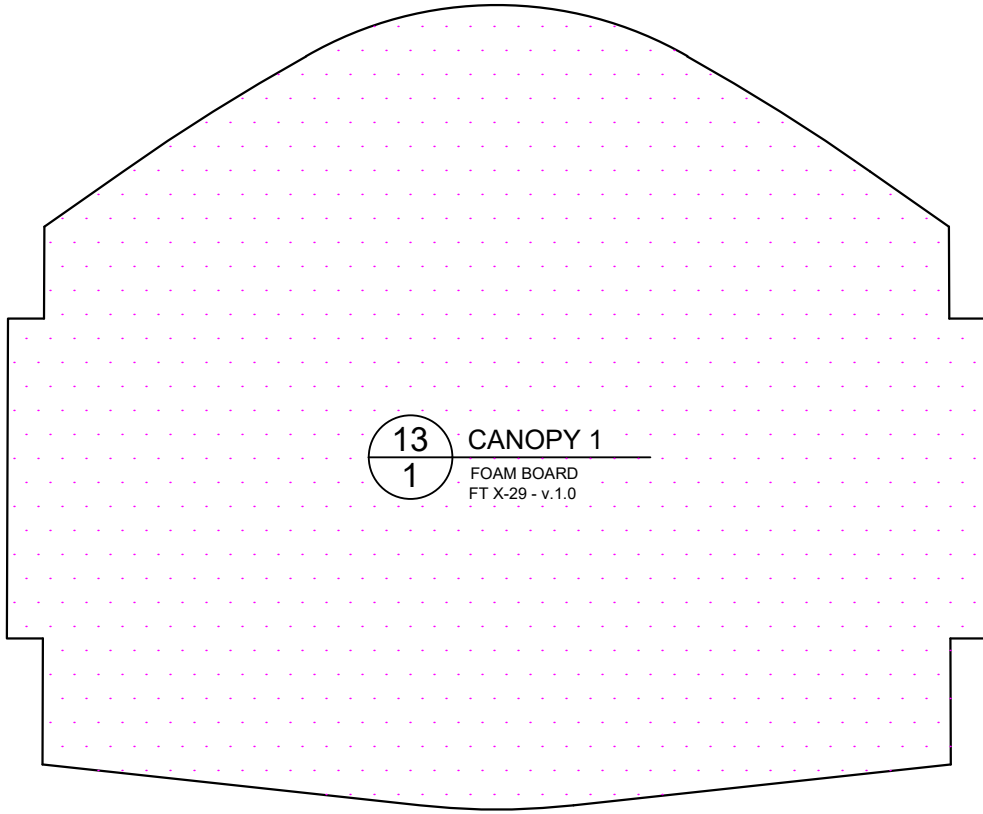

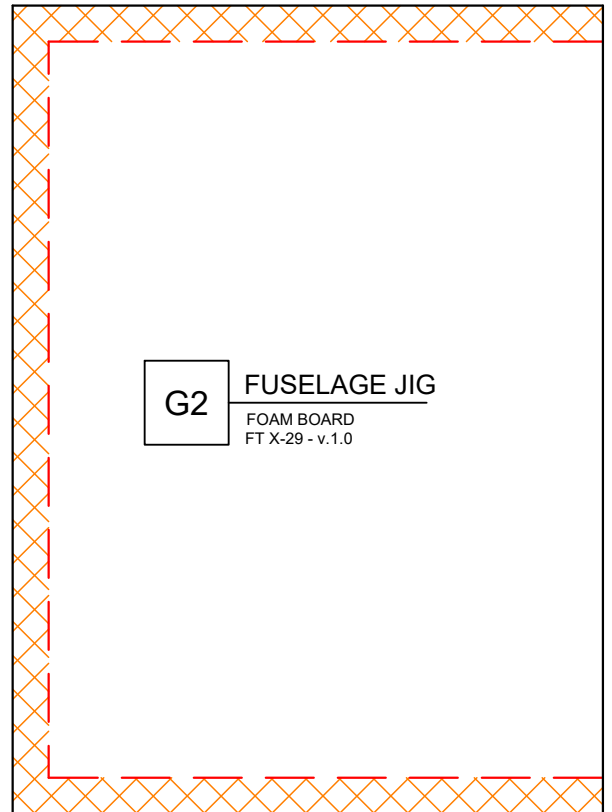
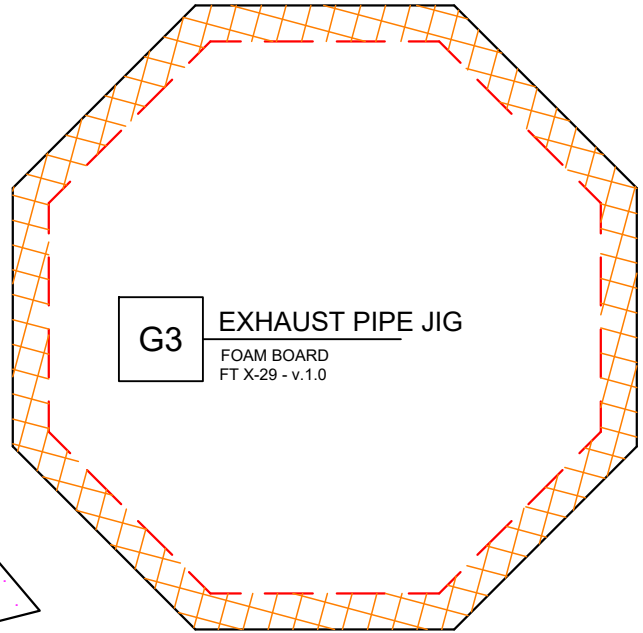
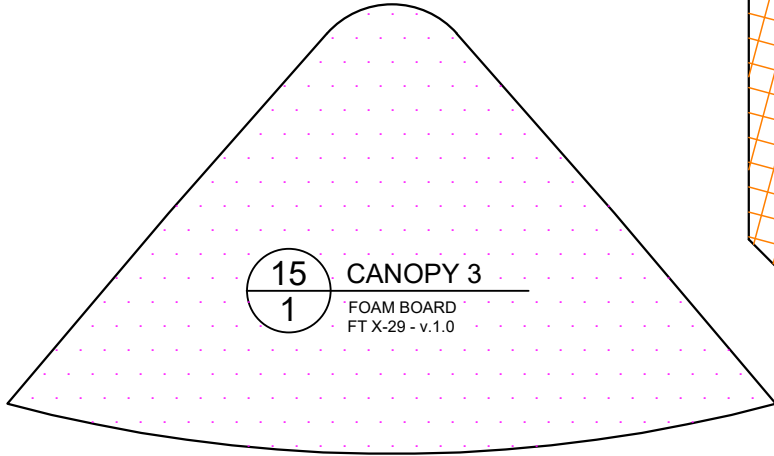



IN
CM

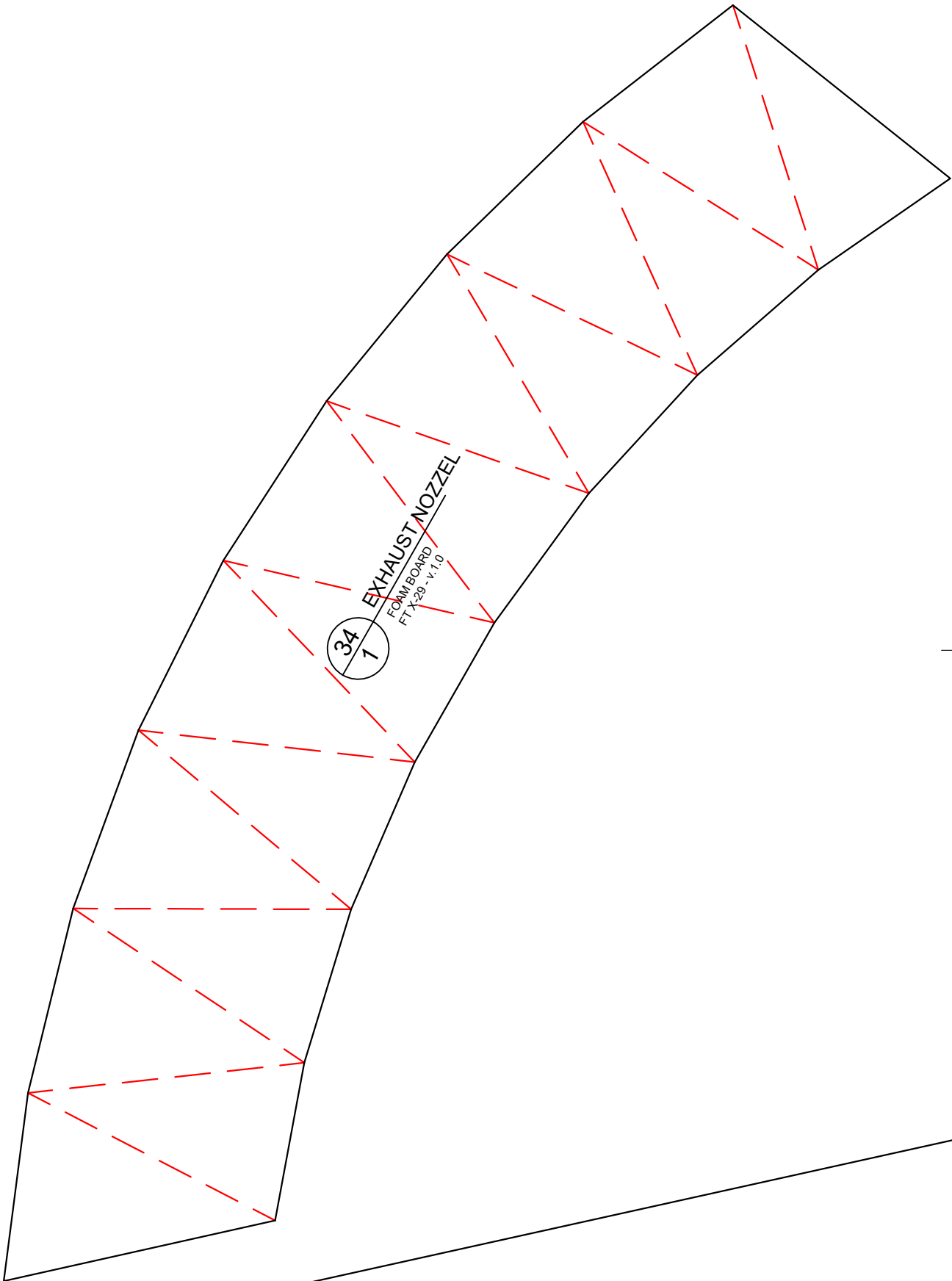

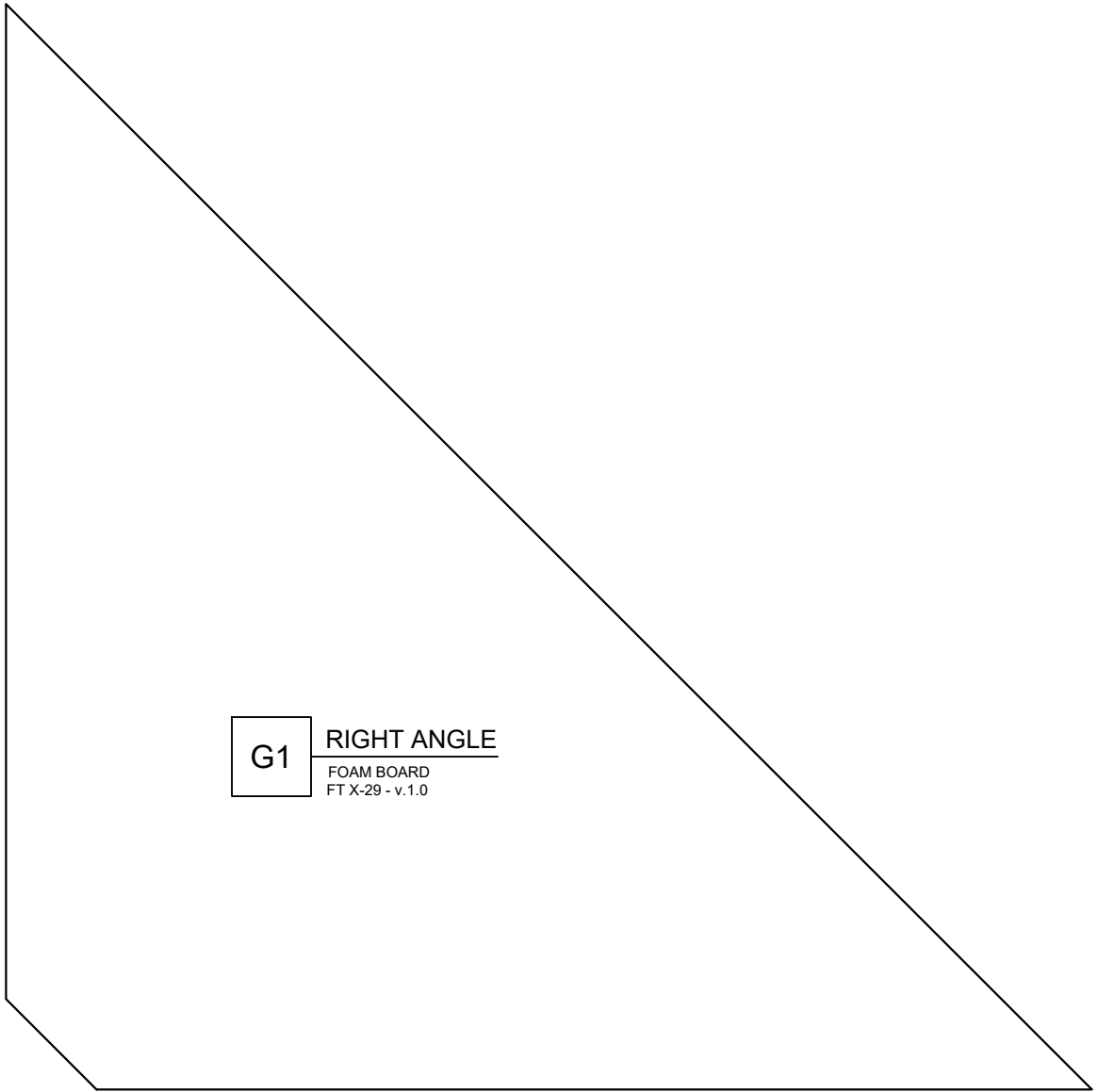

G1 RIGHT ANGLE
FOAM BOARD
FT X-29 - v.1.0

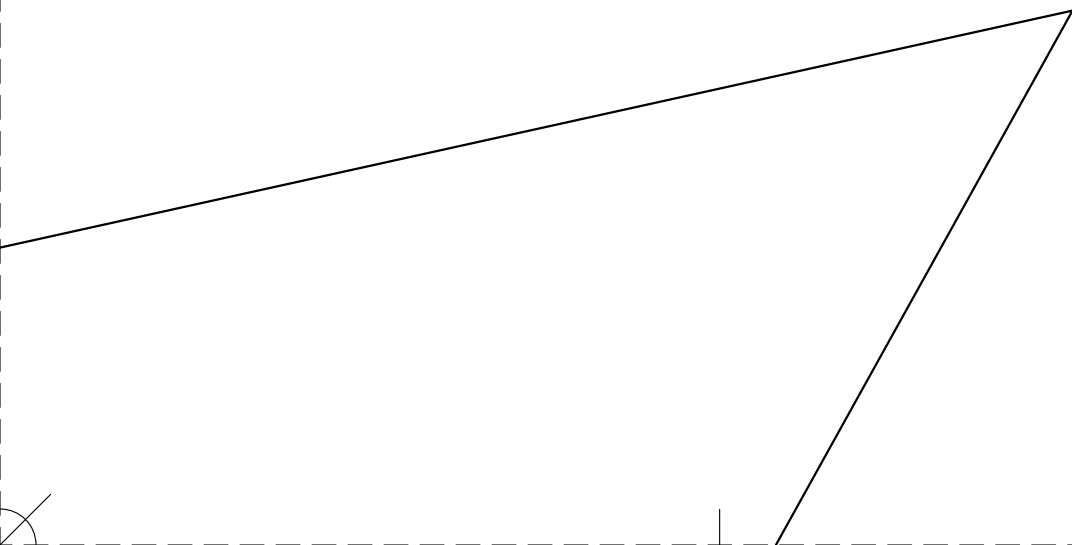



45° SINGLE

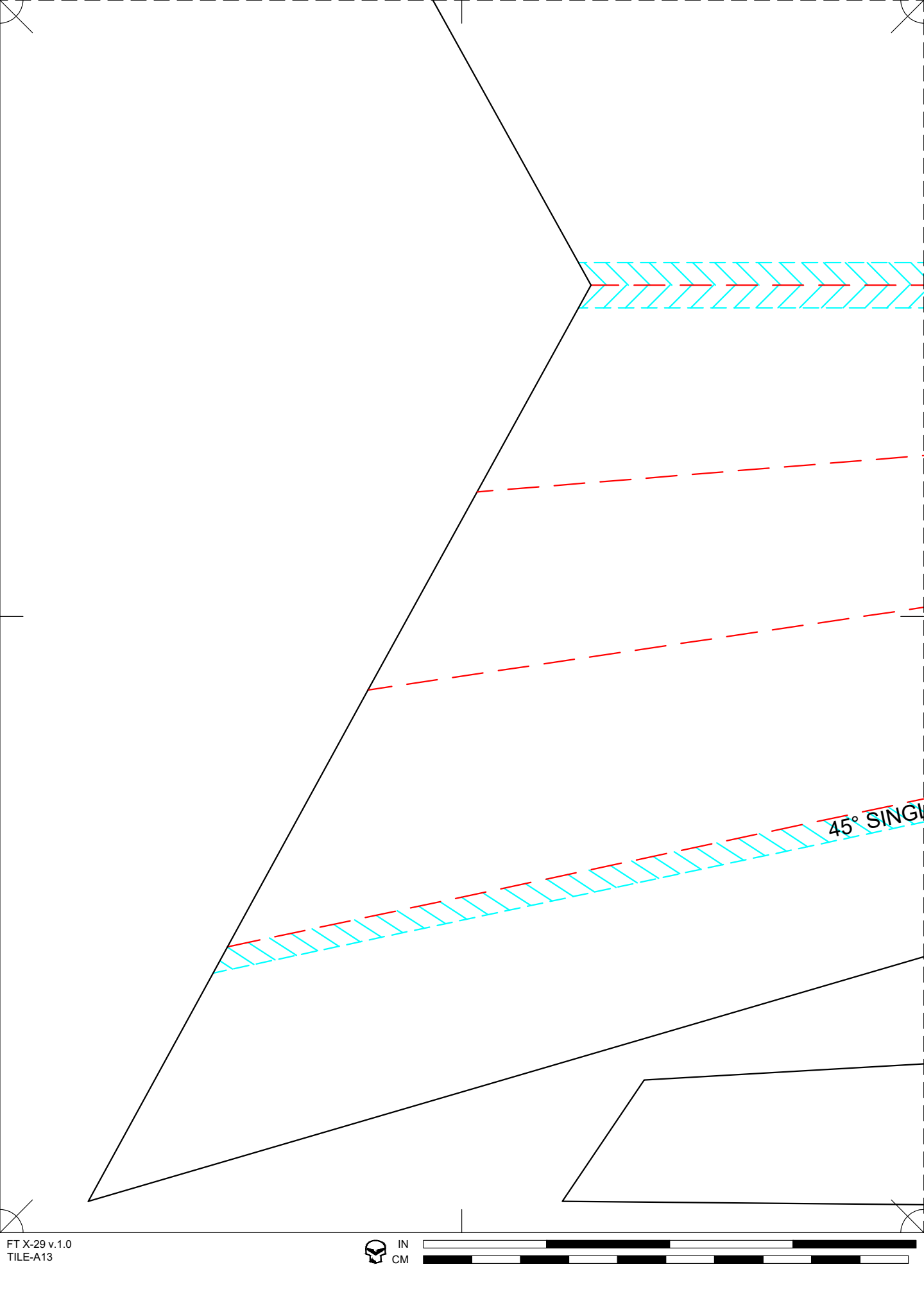

22
1

WING PANEL LEFT

FOAM BOARD
FT X-29 - v.1.0

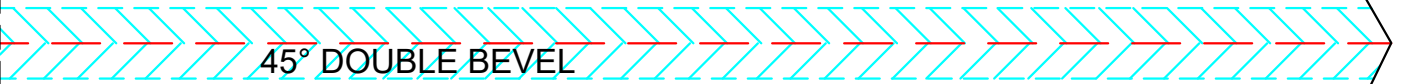

45° DOUBLE BEVEL

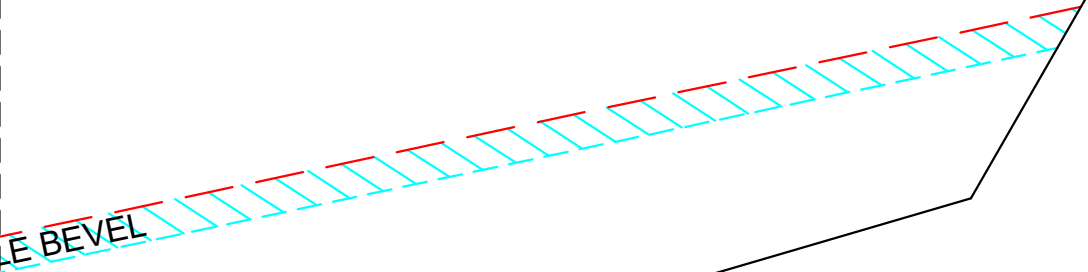
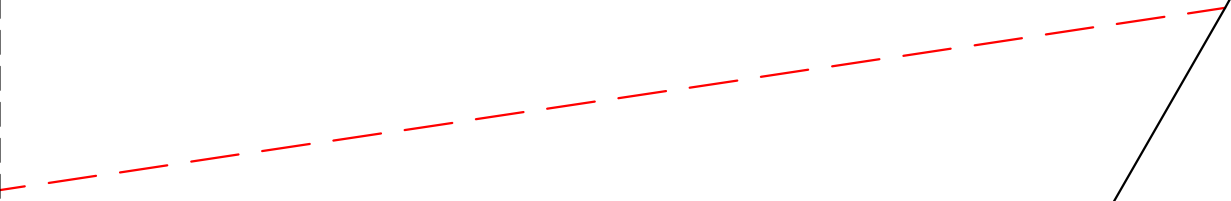
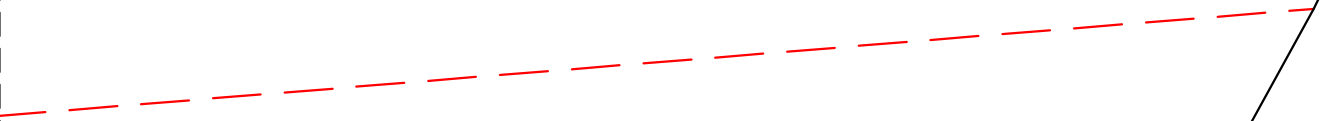

45° BEVEL

27
2

WING SPAR OUTER

FOAM BOARD
FT X-29 - v.1.0

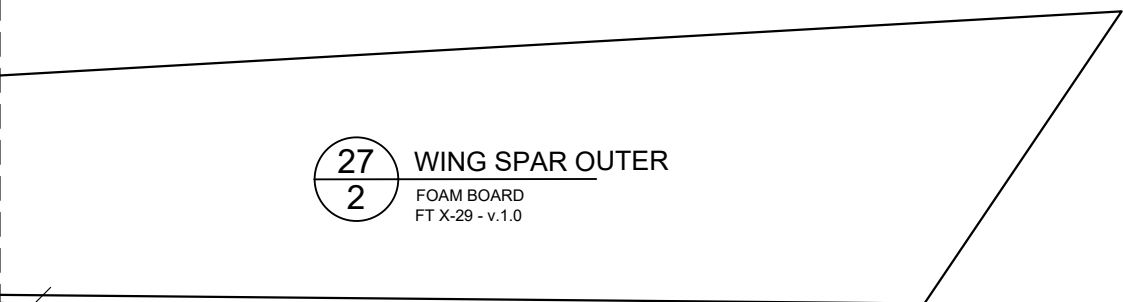

21
1

WING PANEL RIGHT

FOAM BOARD
FT X-29 - v.1.0

45° DOUBLE BEVEL

45° SINGLE BEVEL

27
2

WING SPAR OUTER

FOAM BOARD
FT X-29 - v.1.0



IN
CM



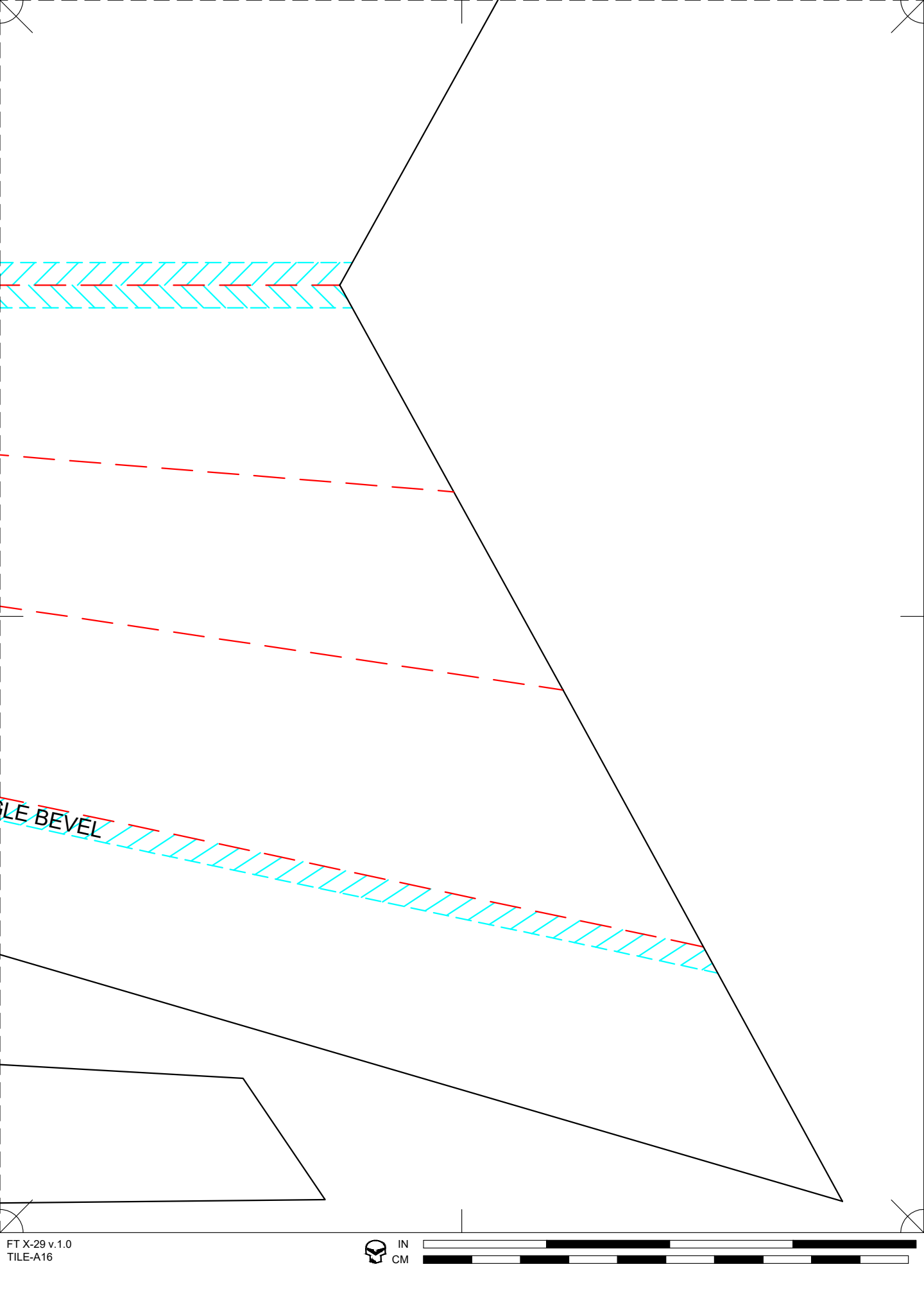



IN
CM

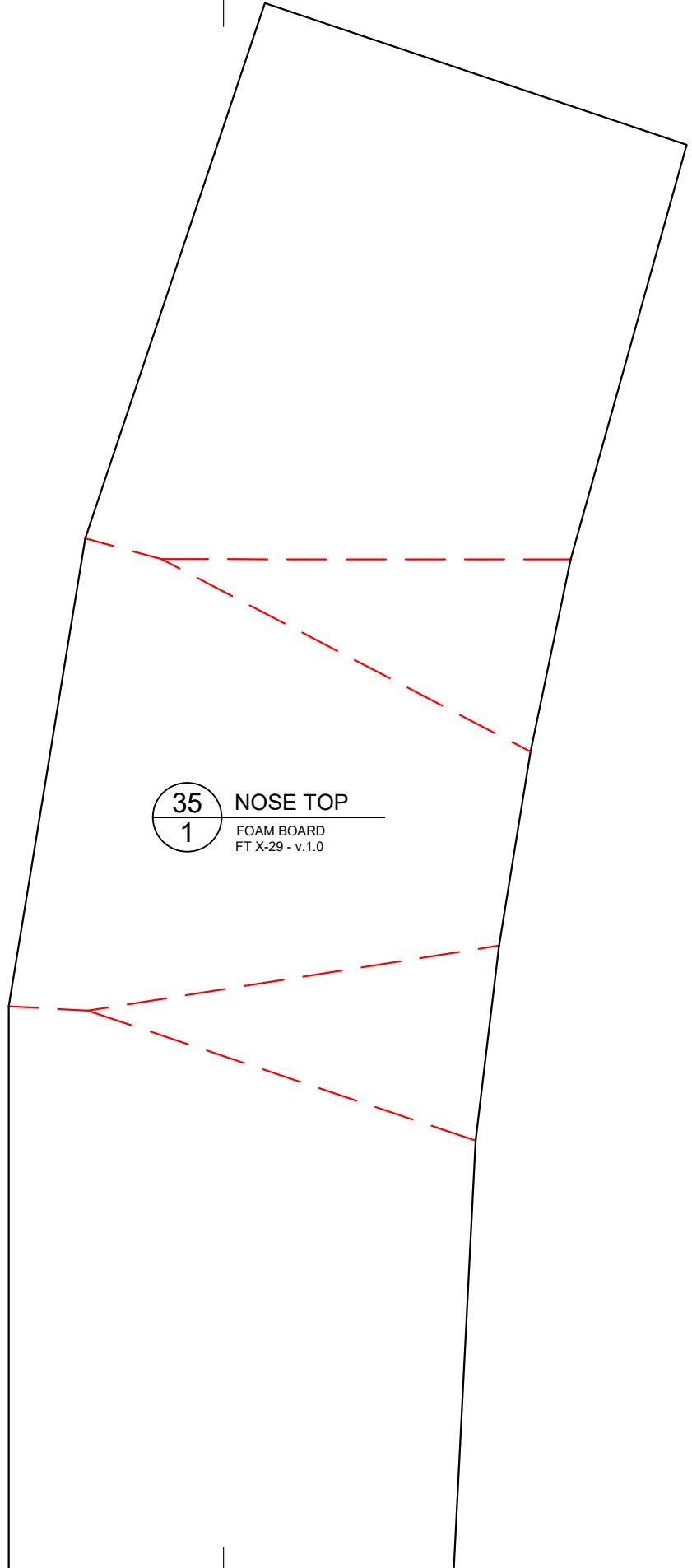

35
1

NOSE TOP

FOAM BOARD
FT X-29 - v.1.0



IN
CM



28
1 VERTICAL STABILIZER
FOAM BOARD
FT X-29 - v.1.0

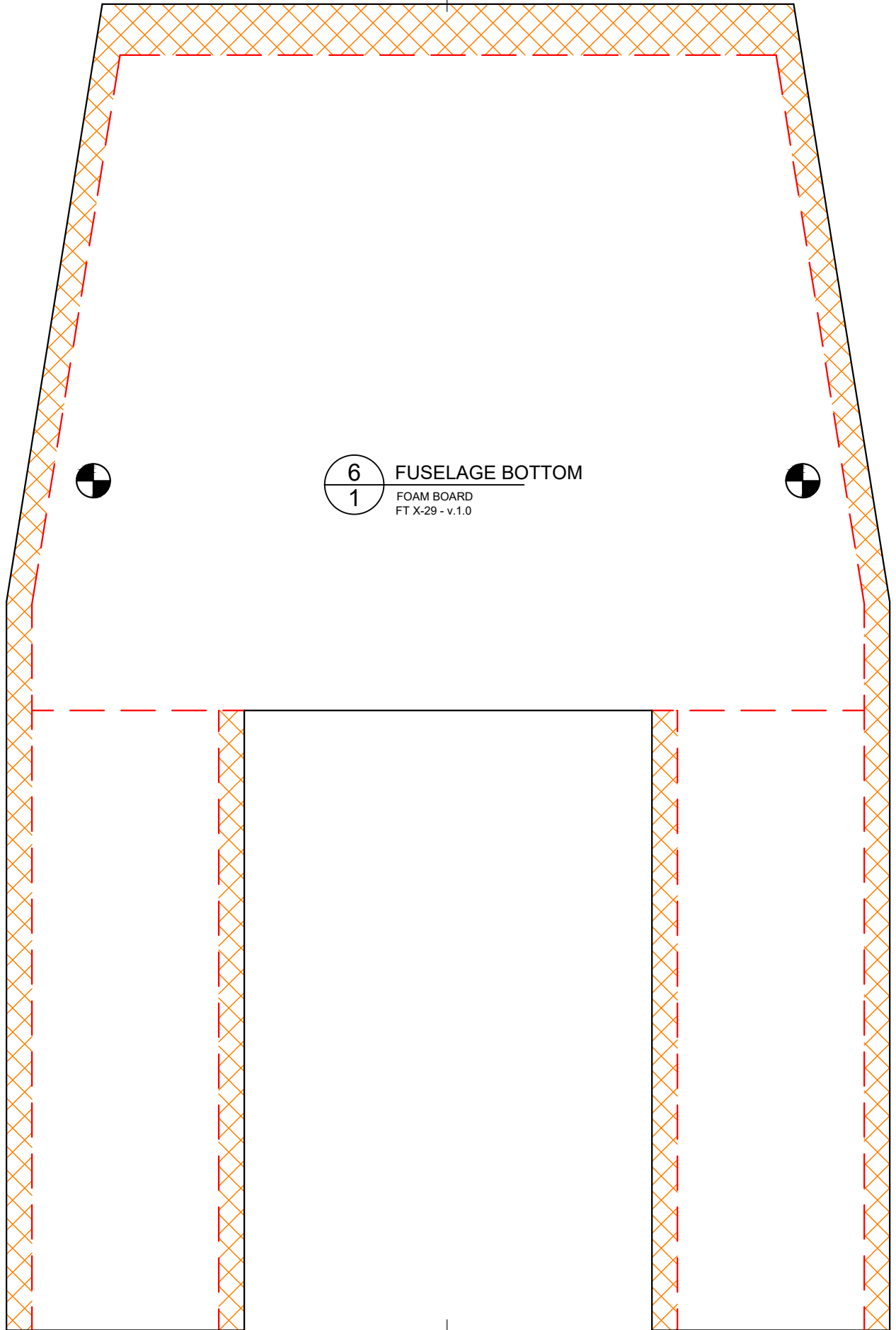

6
1

FUSELAGE BOTTOM

FOAM BOARD
FT X-29 - v.1.0

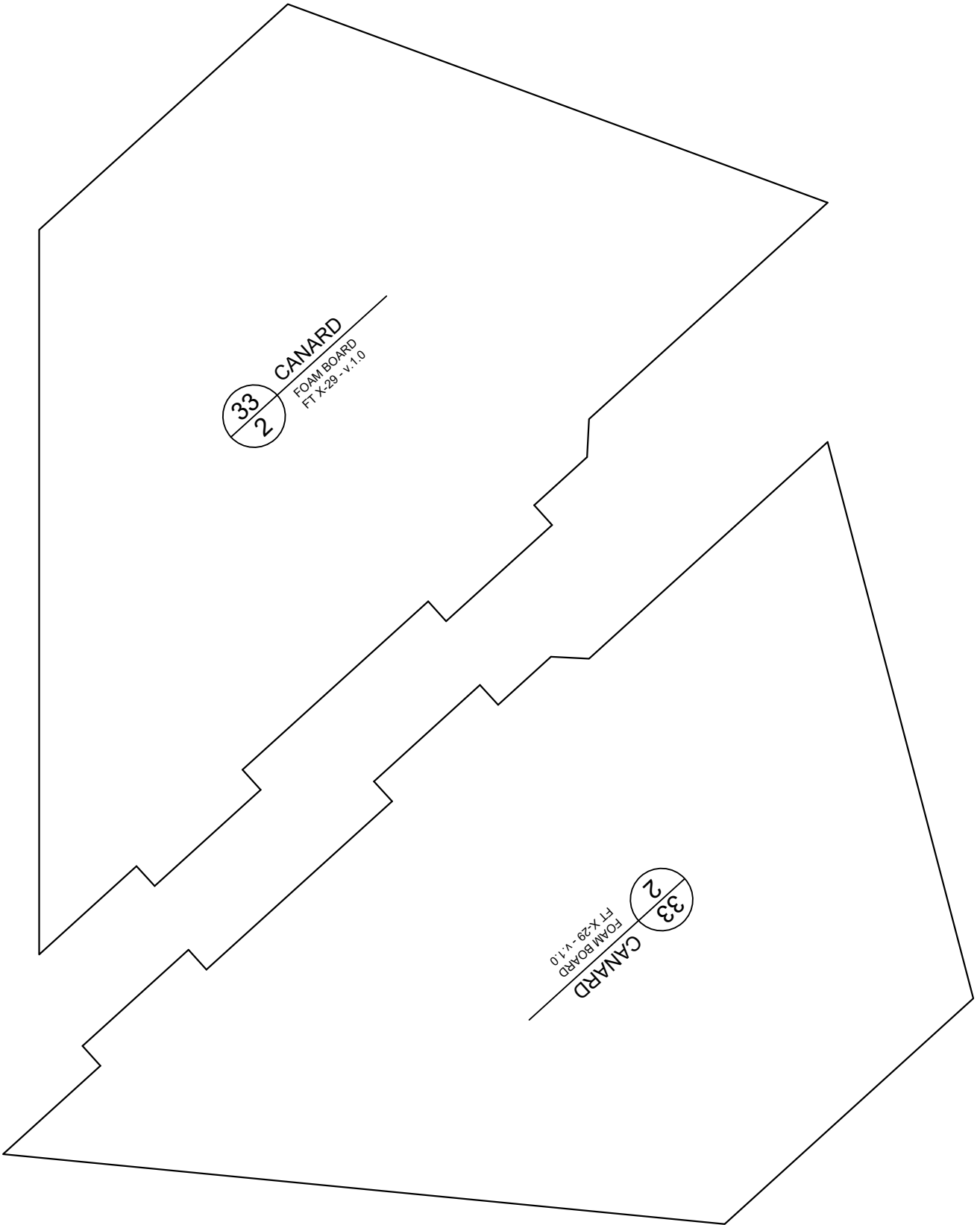

33
2
CAVARD
FOAM BOARD
FT X-29 - v.1.0

33
2
CAVARD
FOAM BOARD
FT X-29 - v.1.0

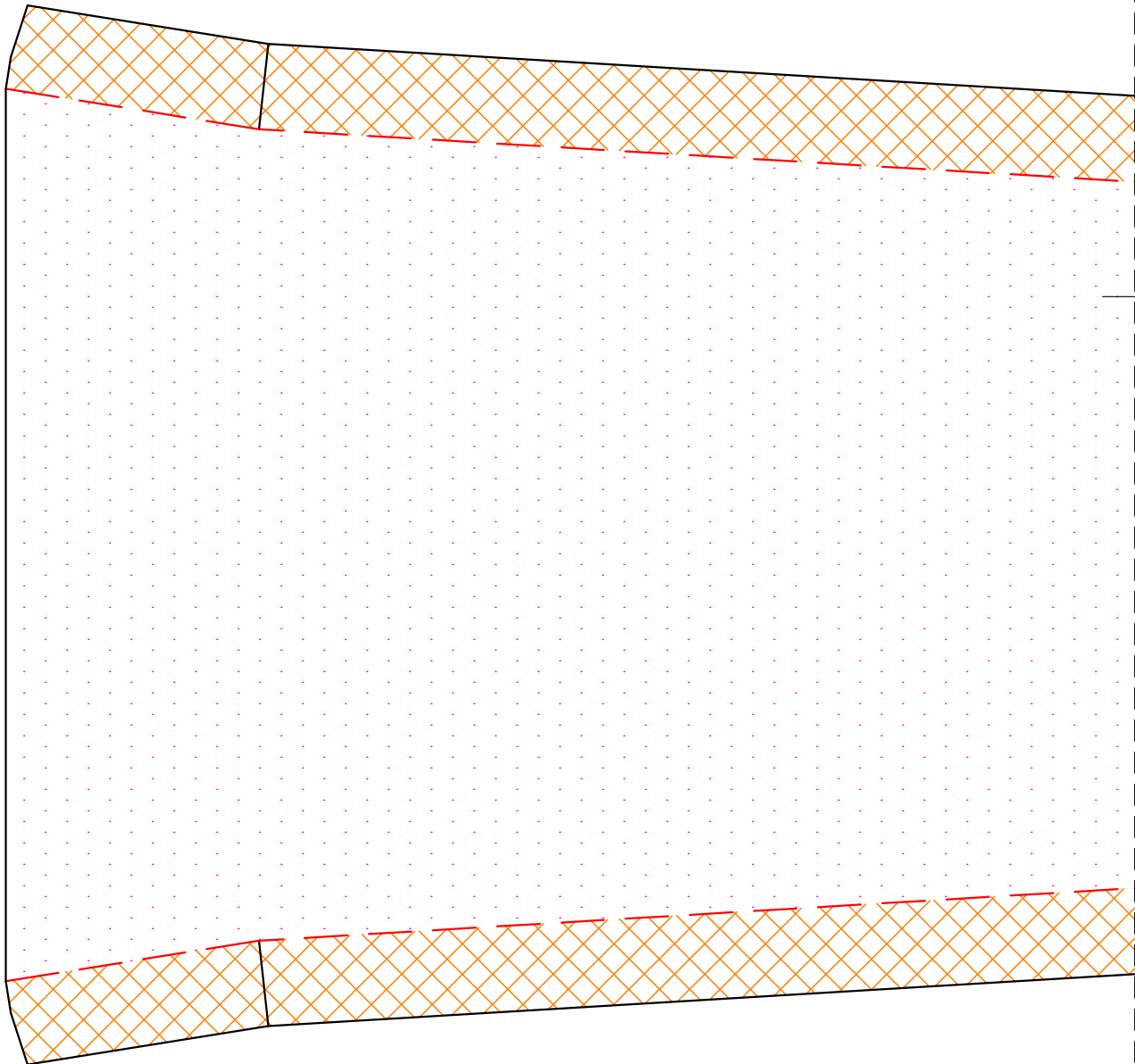

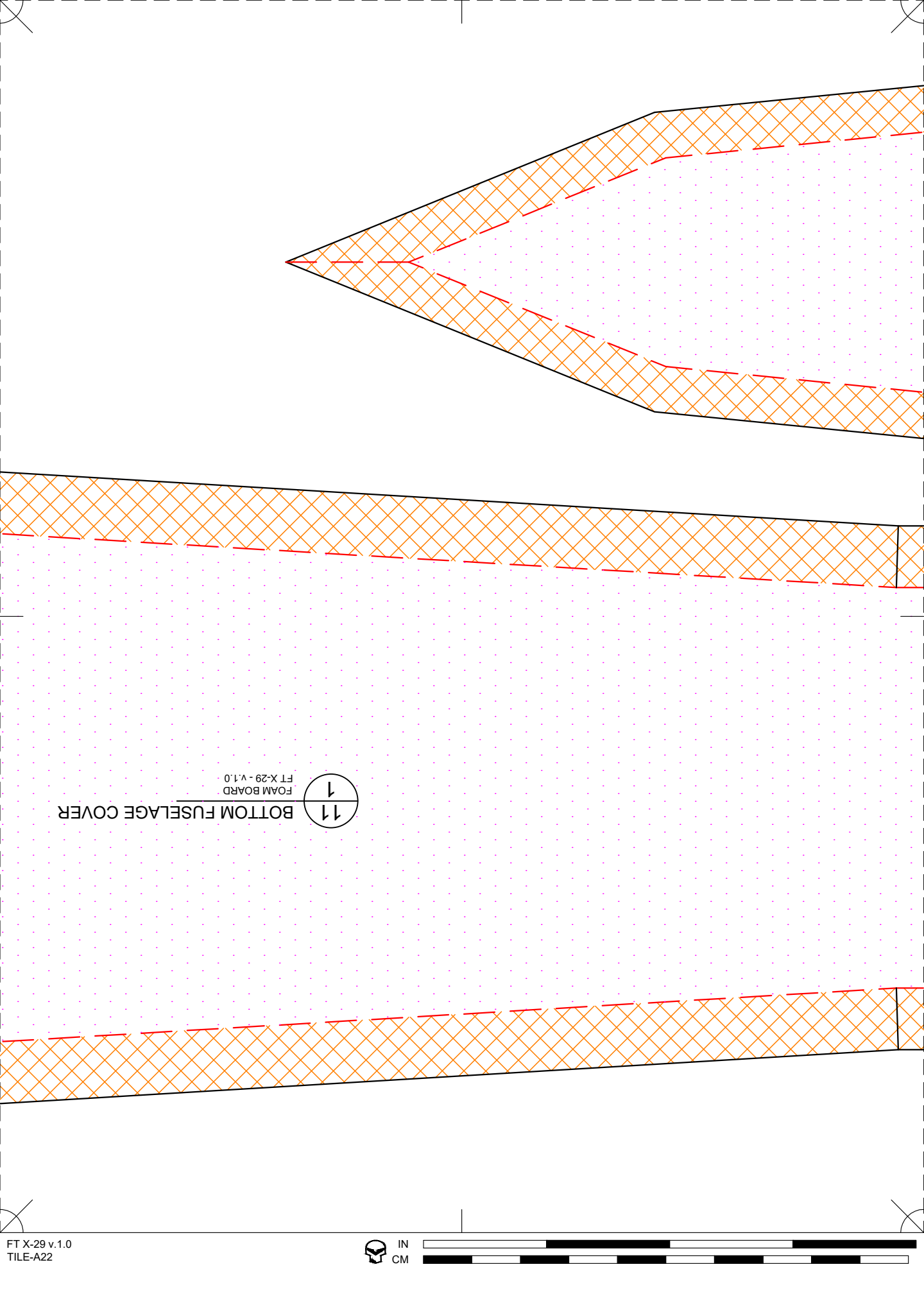

11 1
 1
 FOAM BOARD
 FT X-29 - V1.0
 BOTTOM FUSELAGE COVER

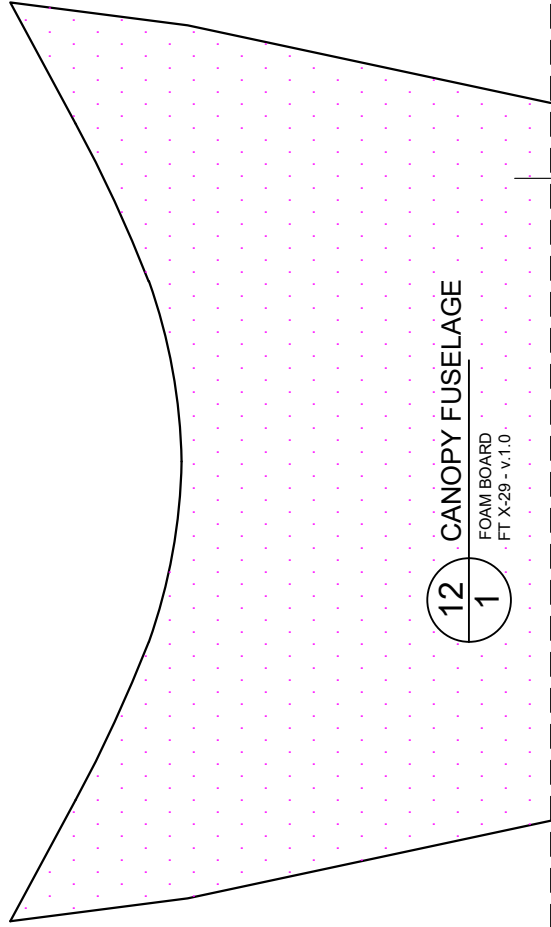
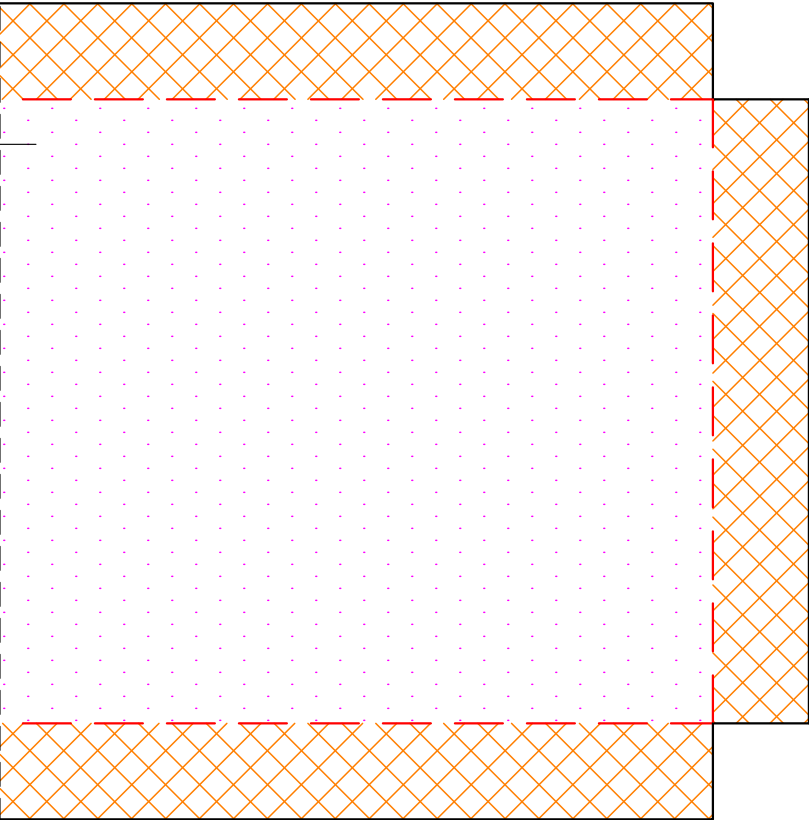
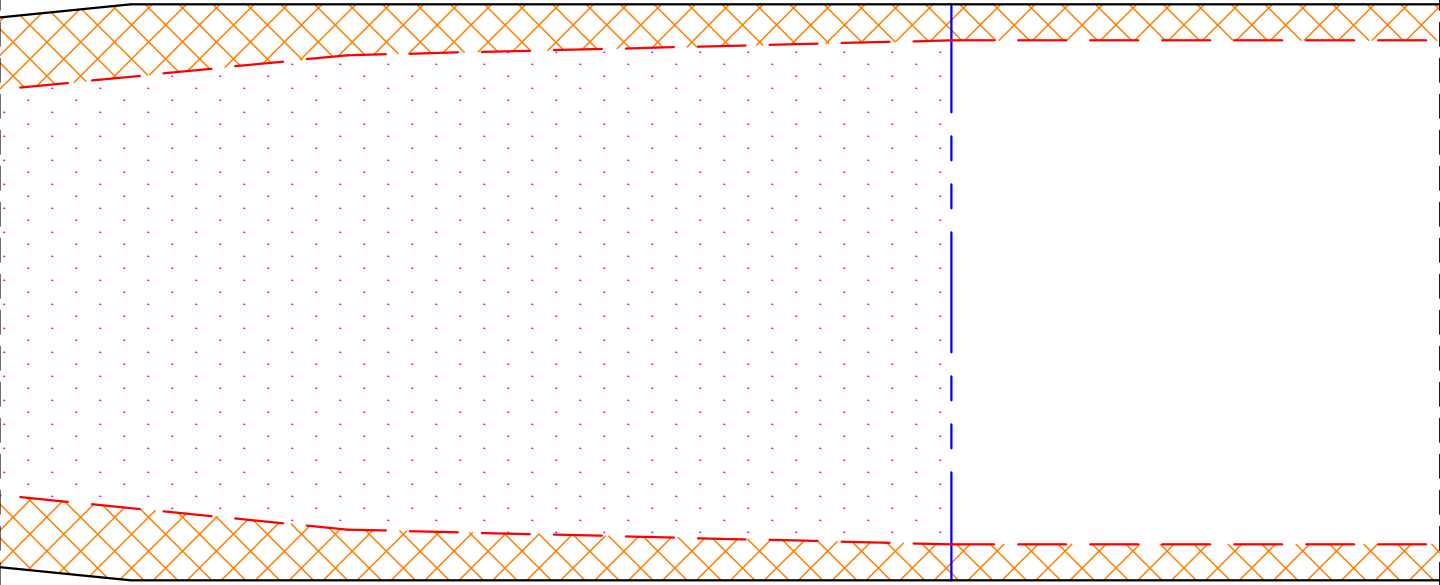

12 CANOPY FUSELAGE

1

FOAM BOARD
FT X-29 - v.1.0



IN
CM



17
1

NOSE BOTTOM
FOAM BOARD
FT X-29 - V.1.0

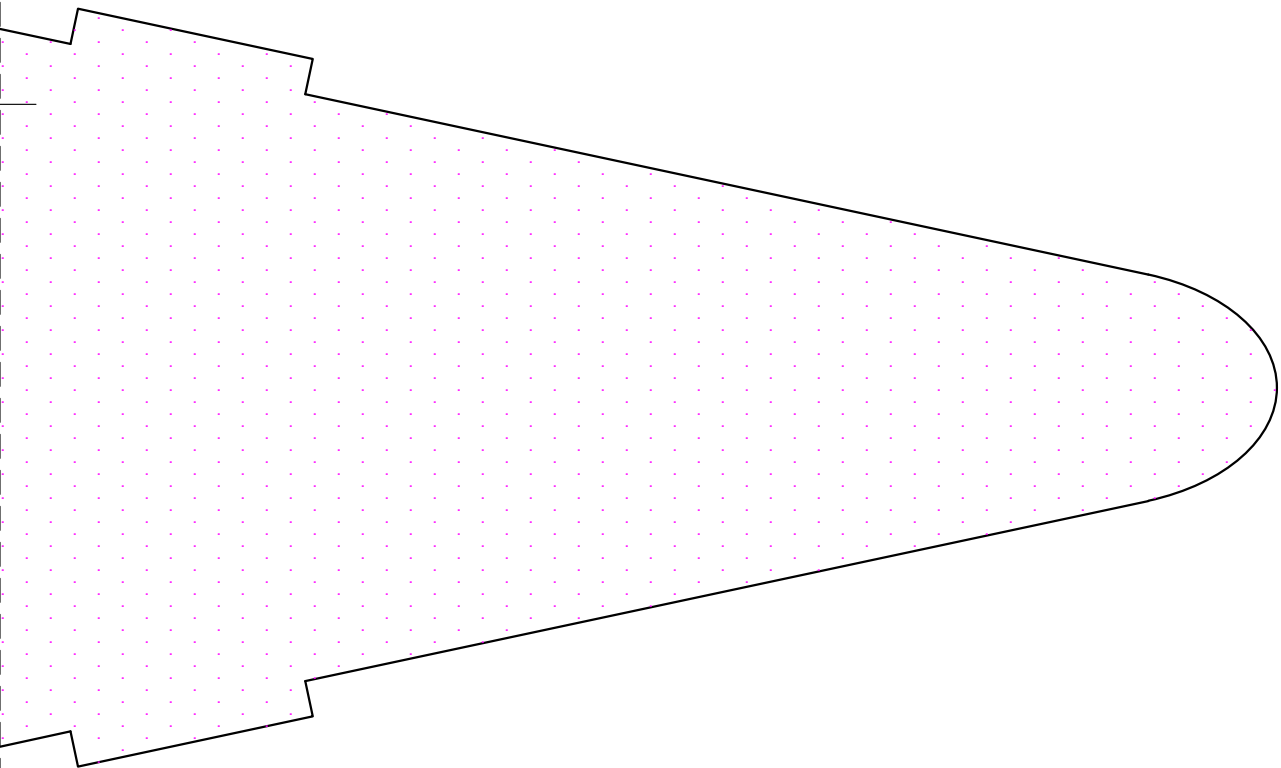



IN
CM

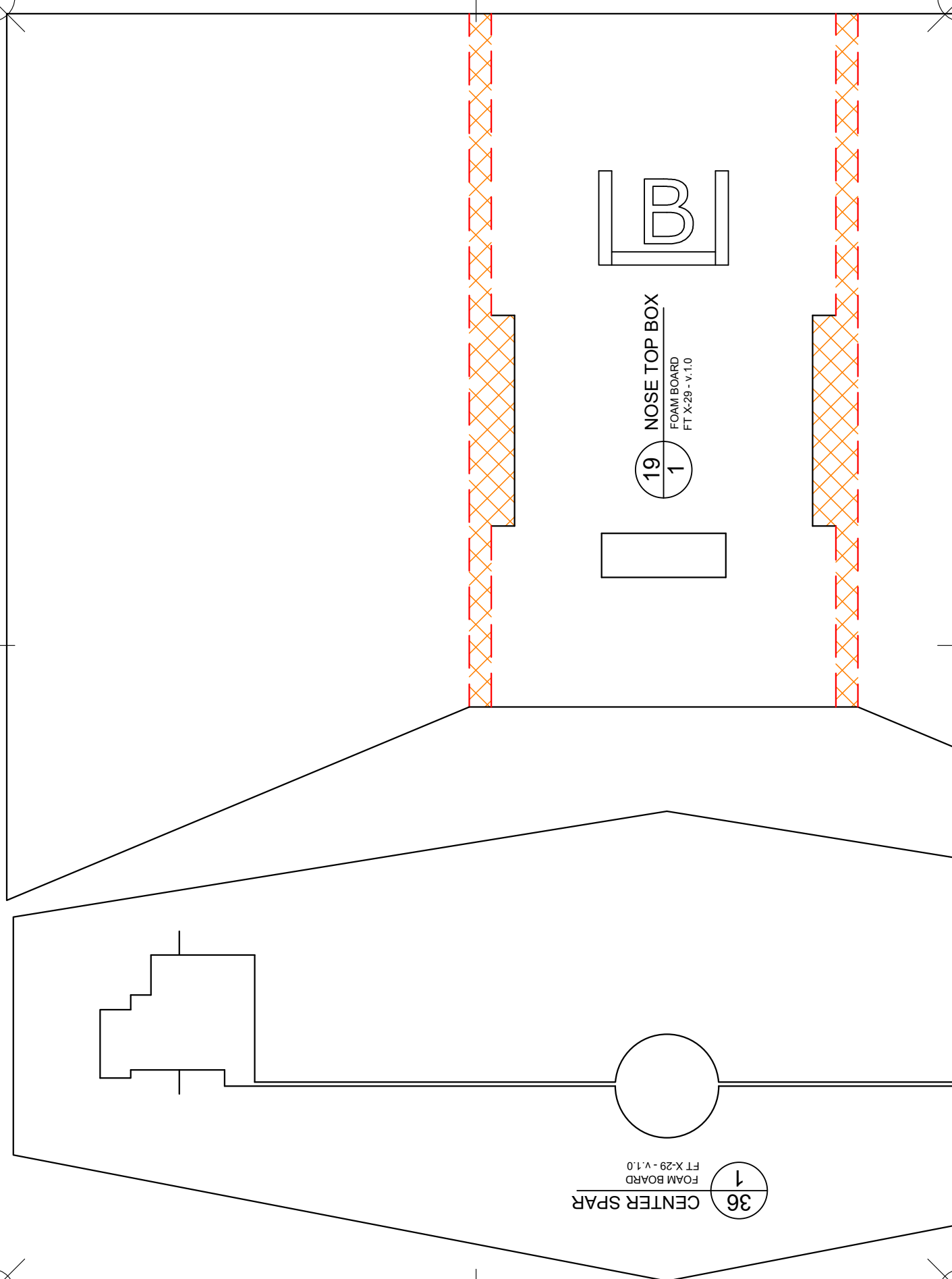

B

19 | 1
NOSE TOP BOX
FOAM BOARD
FT X-29 - v.1.0



36 | 1
CENTER SPAR
FOAM BOARD
FT X-29 - v.1.0

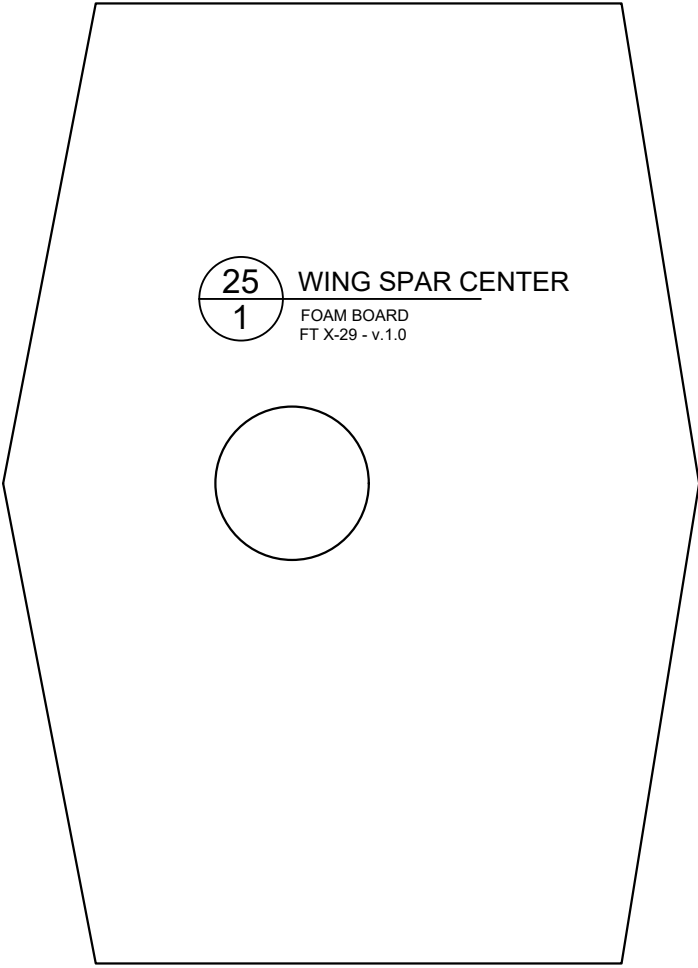
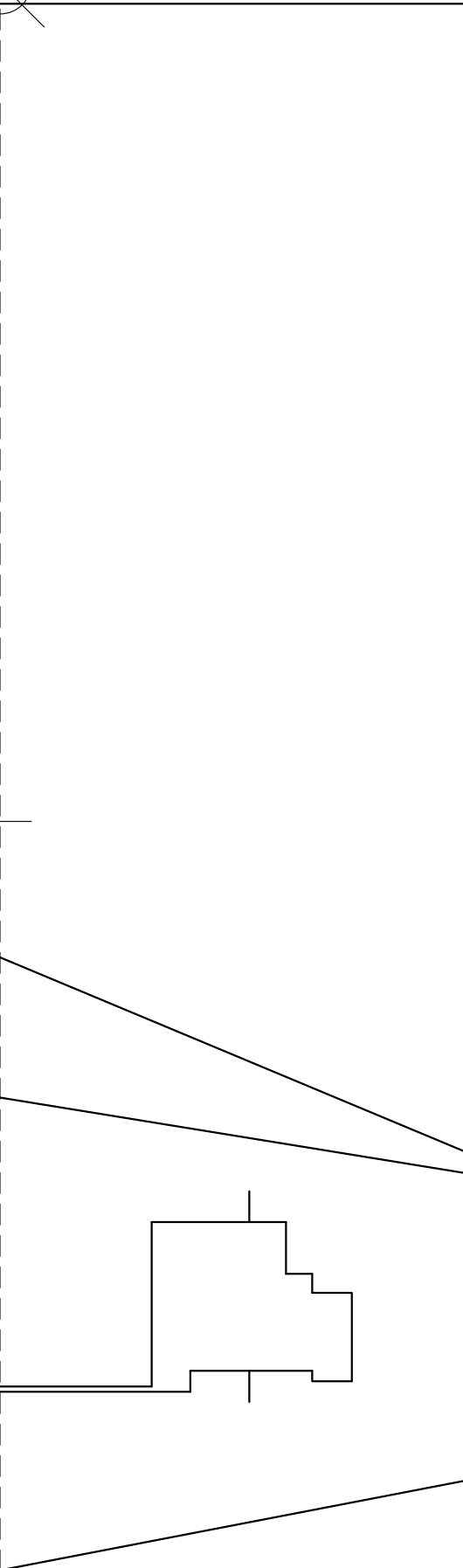

25 WING SPAR CENTER
1 FOAM BOARD
FT X-29 - v.1.0

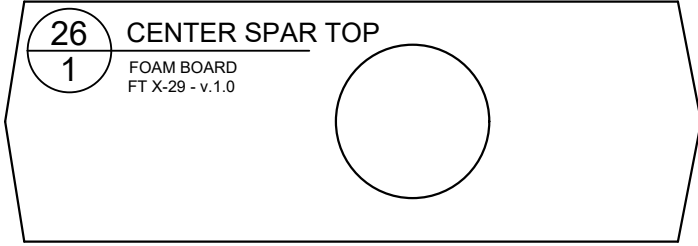
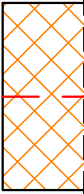

26 CENTER SPAR TOP
1 FOAM BOARD
FT X-29 - v.1.0

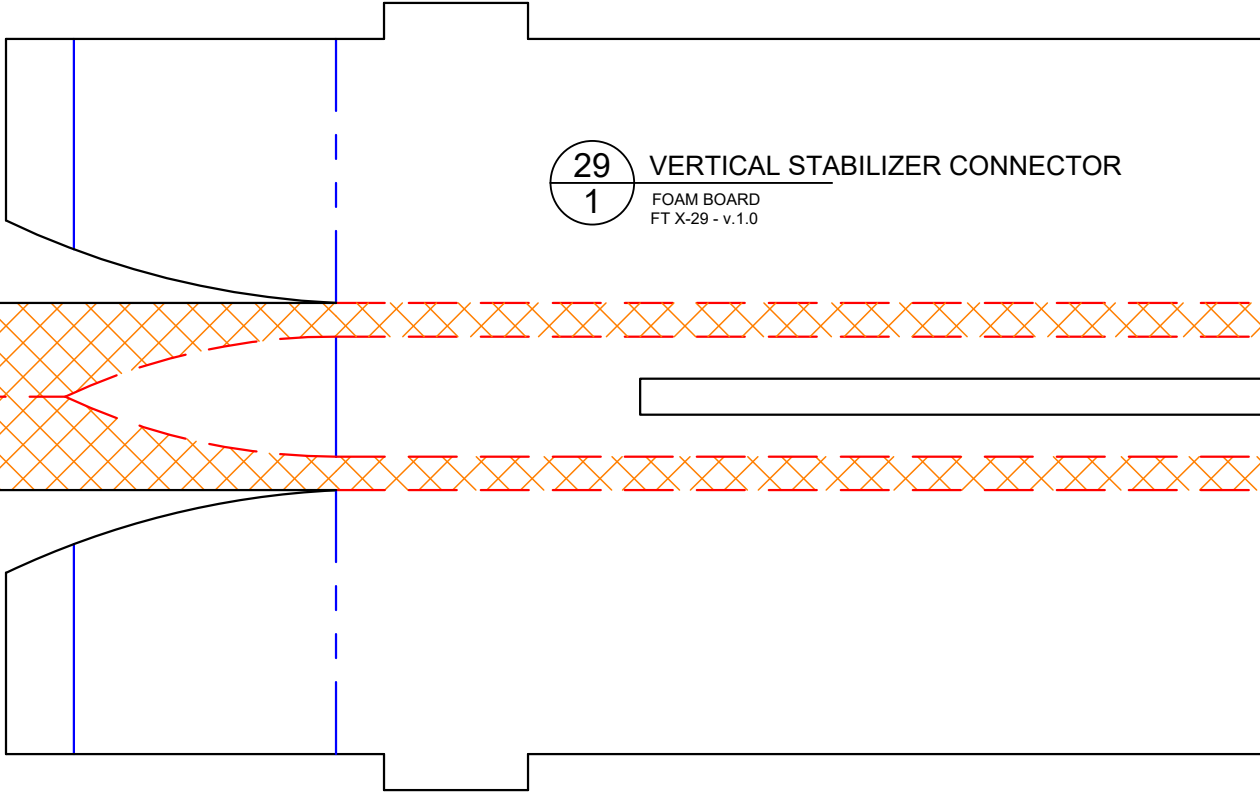

29
1

VERTICAL STABILIZER CONNECTOR

FOAM BOARD
FT X-29 - v.1.0

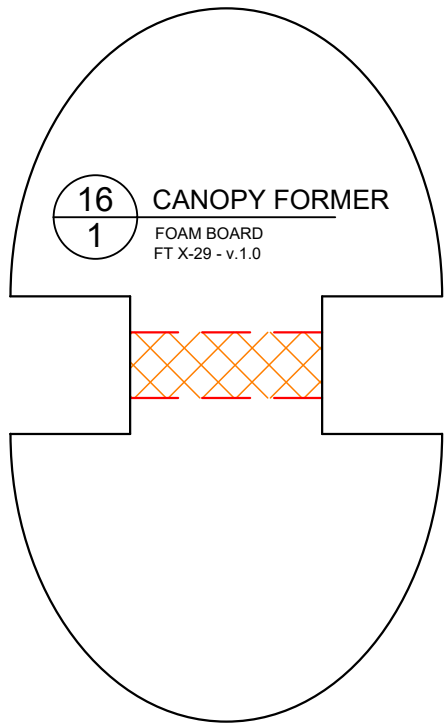

16
1

CANOPY FORMER

FOAM BOARD
FT X-29 - v.1.0

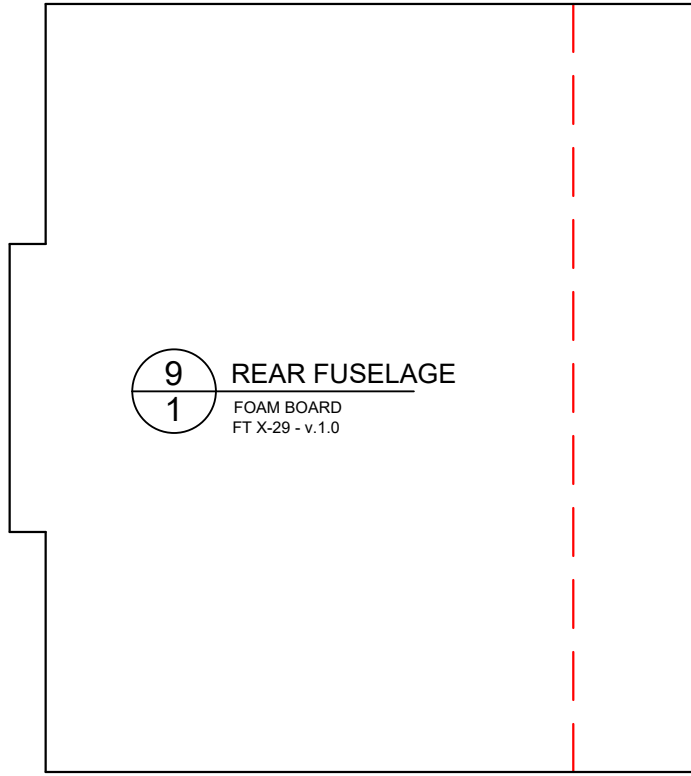

9
1

REAR FUSELAGE

FOAM BOARD
FT X-29 - v.1.0



IN
CM

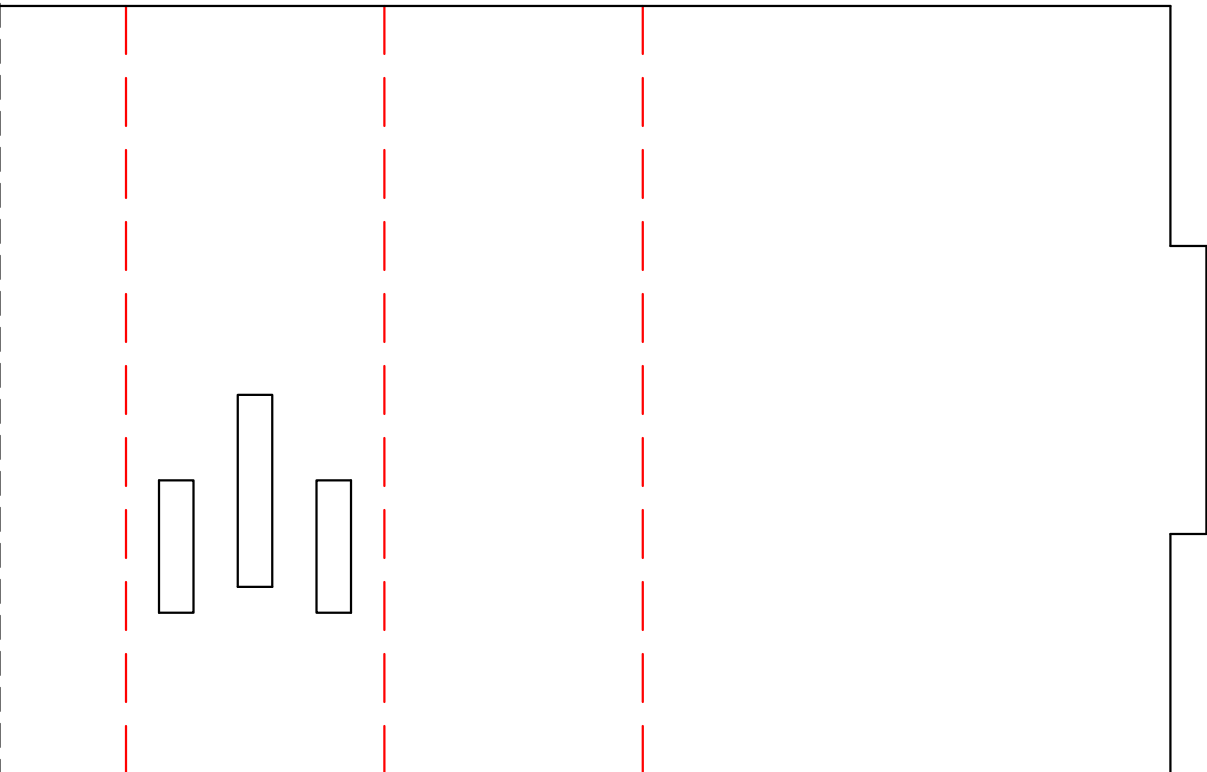
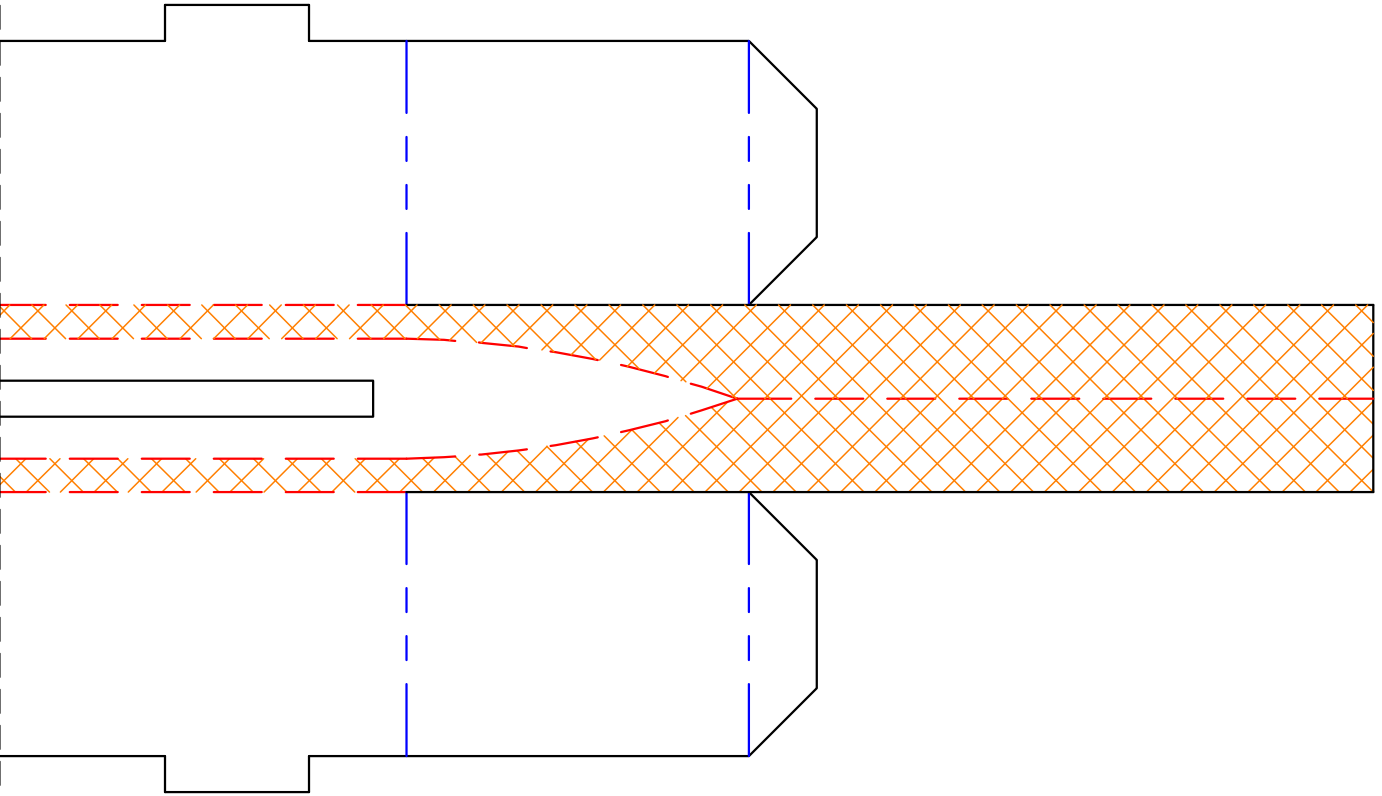



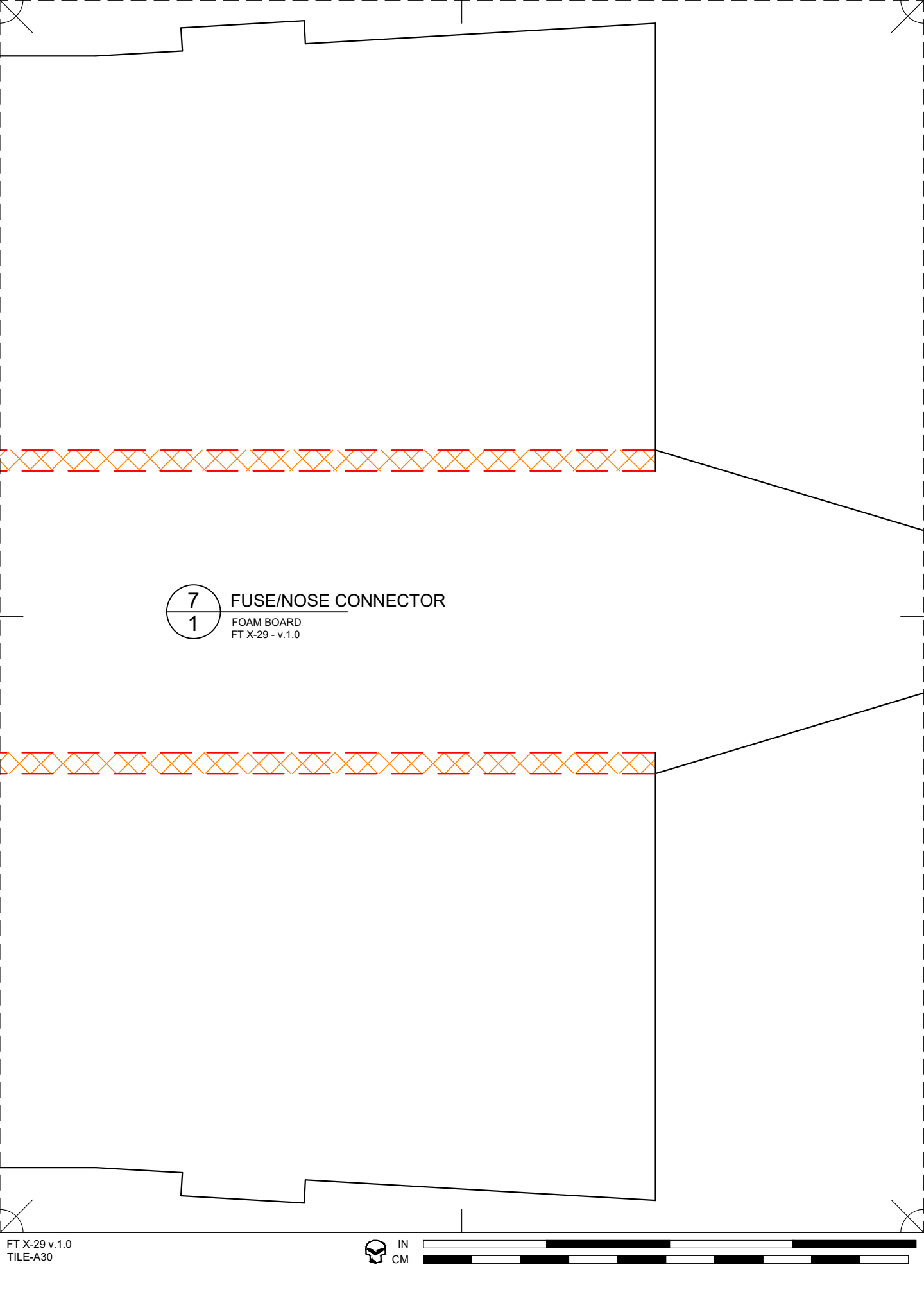

7
1

FUSE/NOSE CONNECTOR

FOAM BOARD
FT X-29 - v.1.0



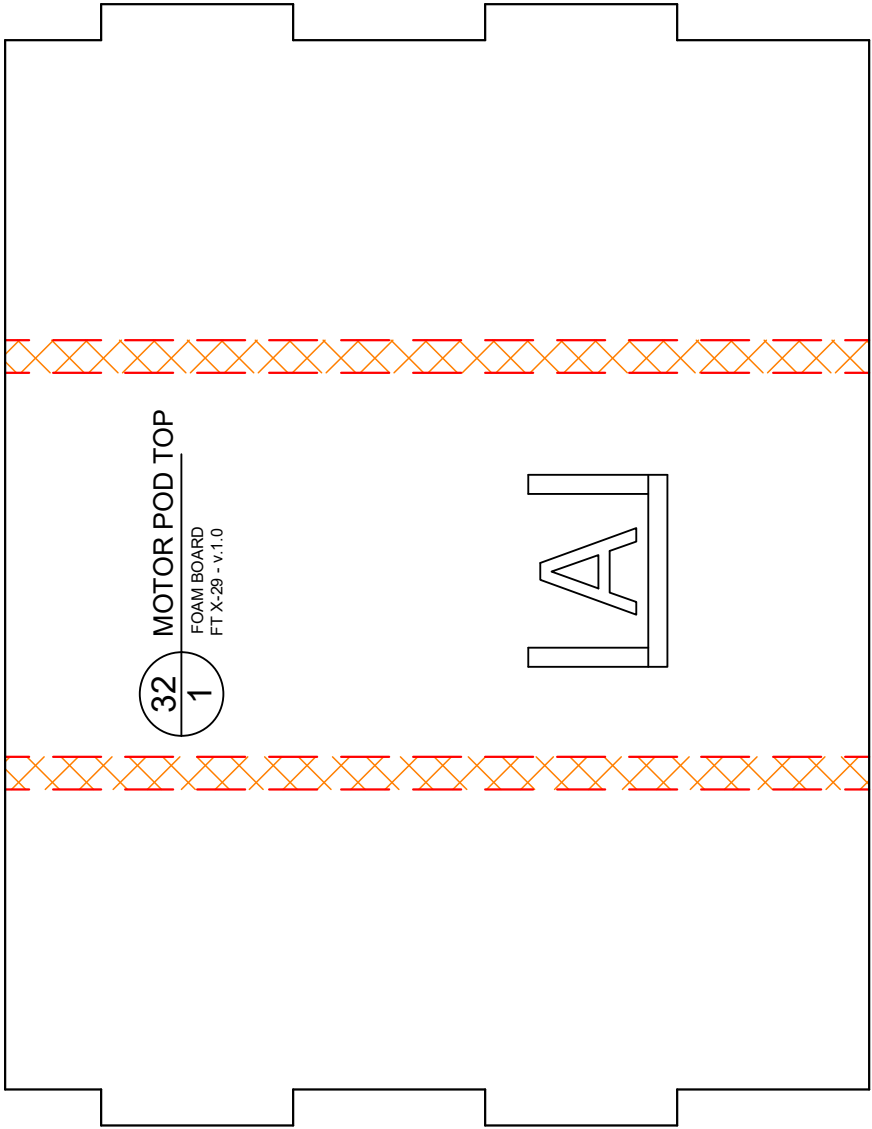

32
1

MOTOR POD TOP

FOAM BOARD
FT X-29 - v.1.0

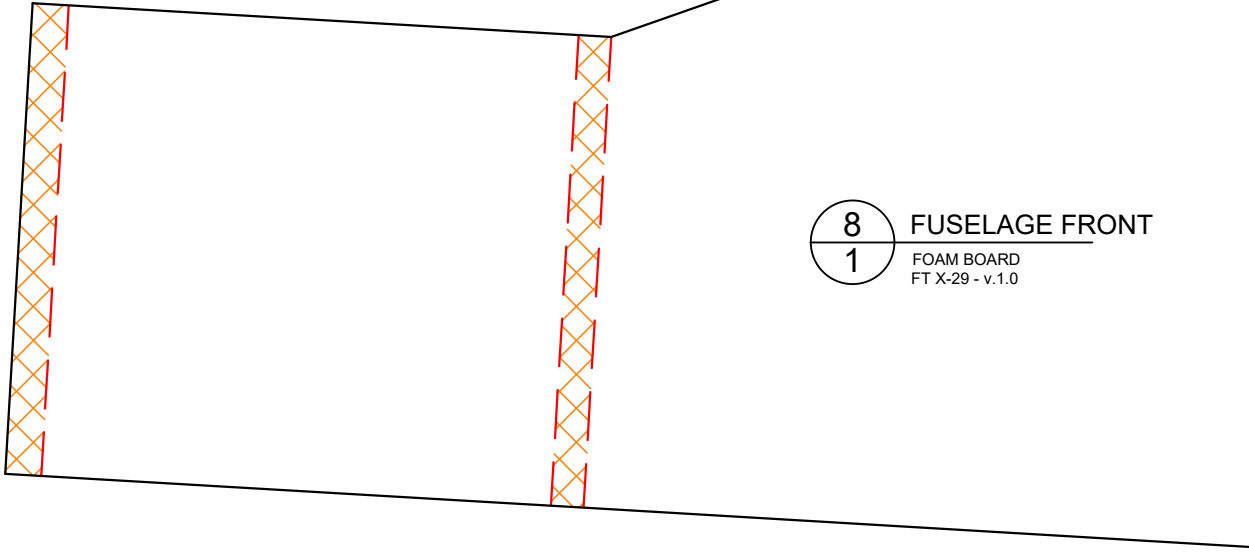
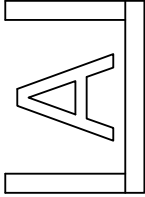

8
1

FUSELAGE FRONT

FOAM BOARD
FT X-29 - v.1.0

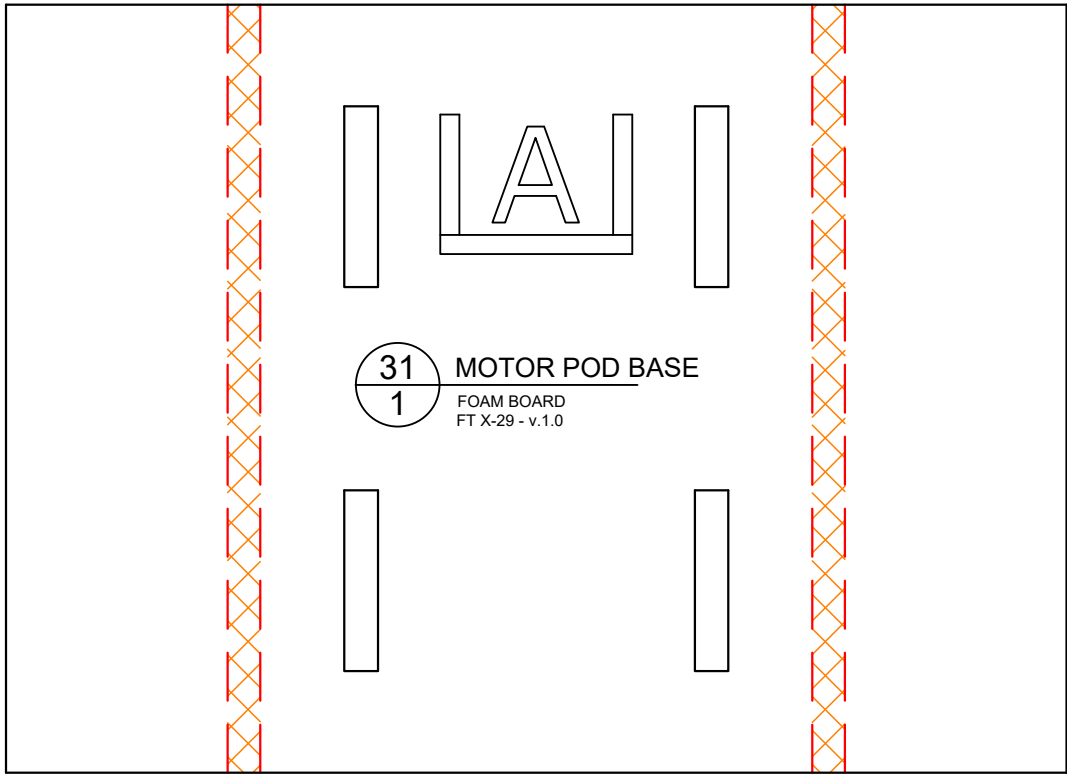

MOTOR POD BASE

FOAM BOARD
FT X-29 - v.1.0

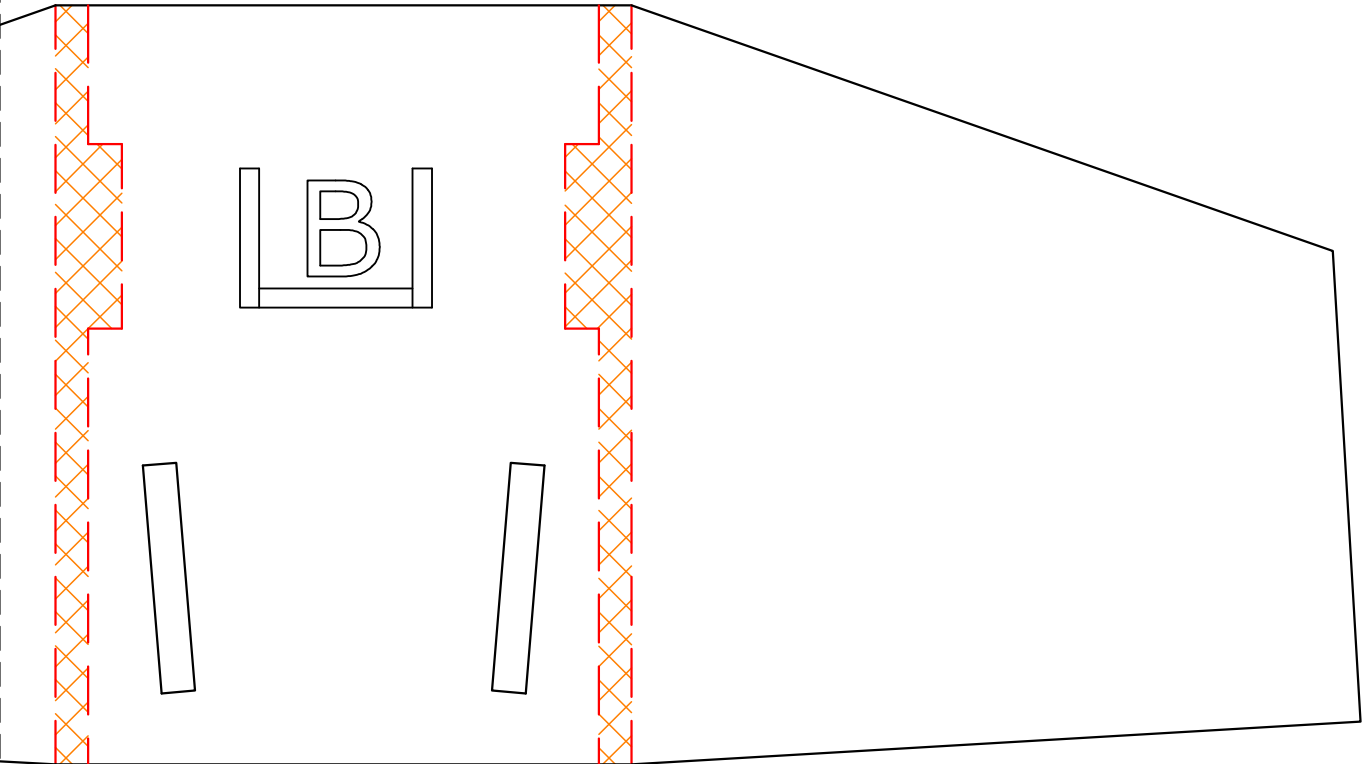

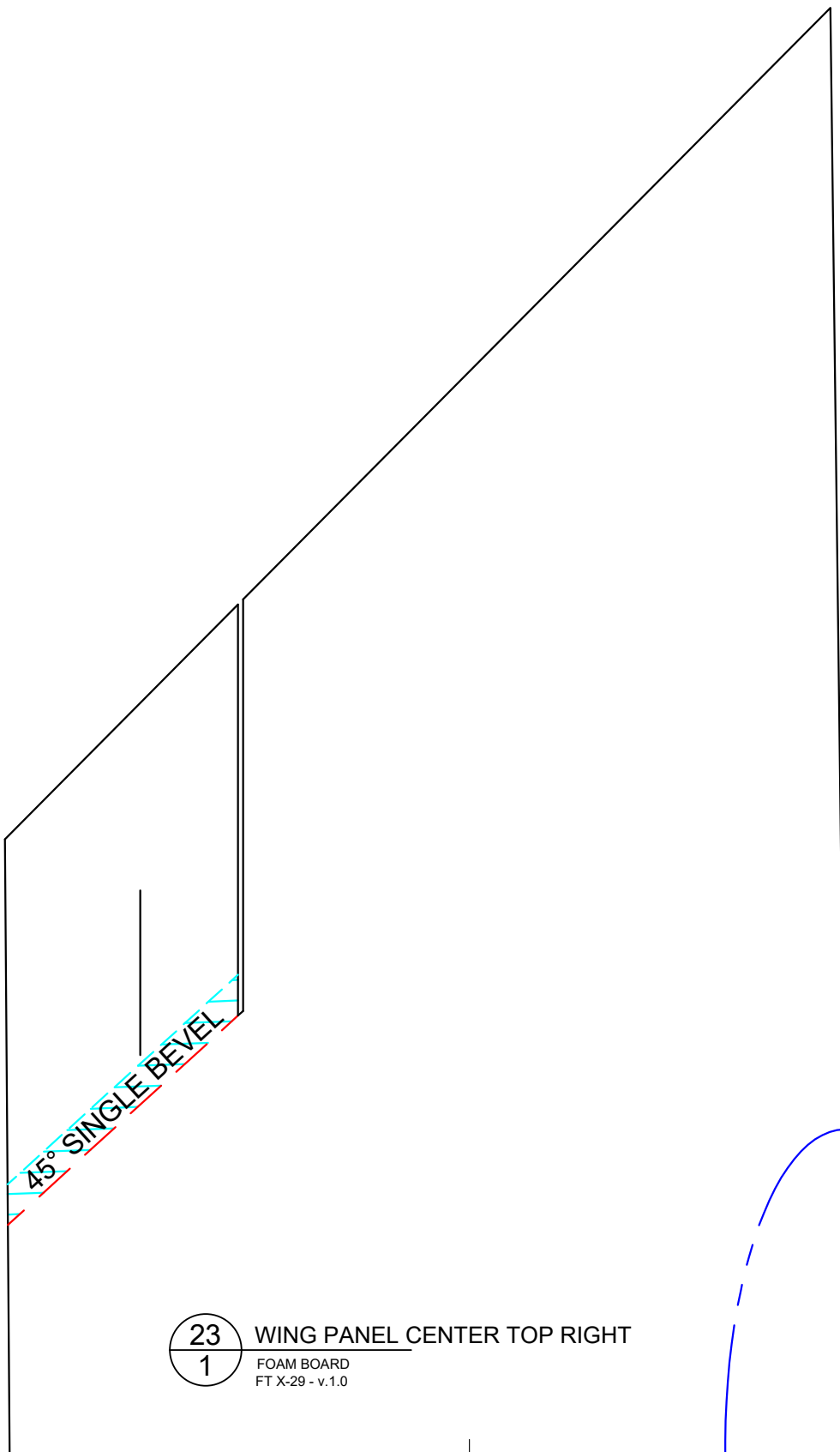

23
1

WING PANEL CENTER TOP RIGHT

FOAM BOARD
FT X-29 - v.1.0



IN
CM

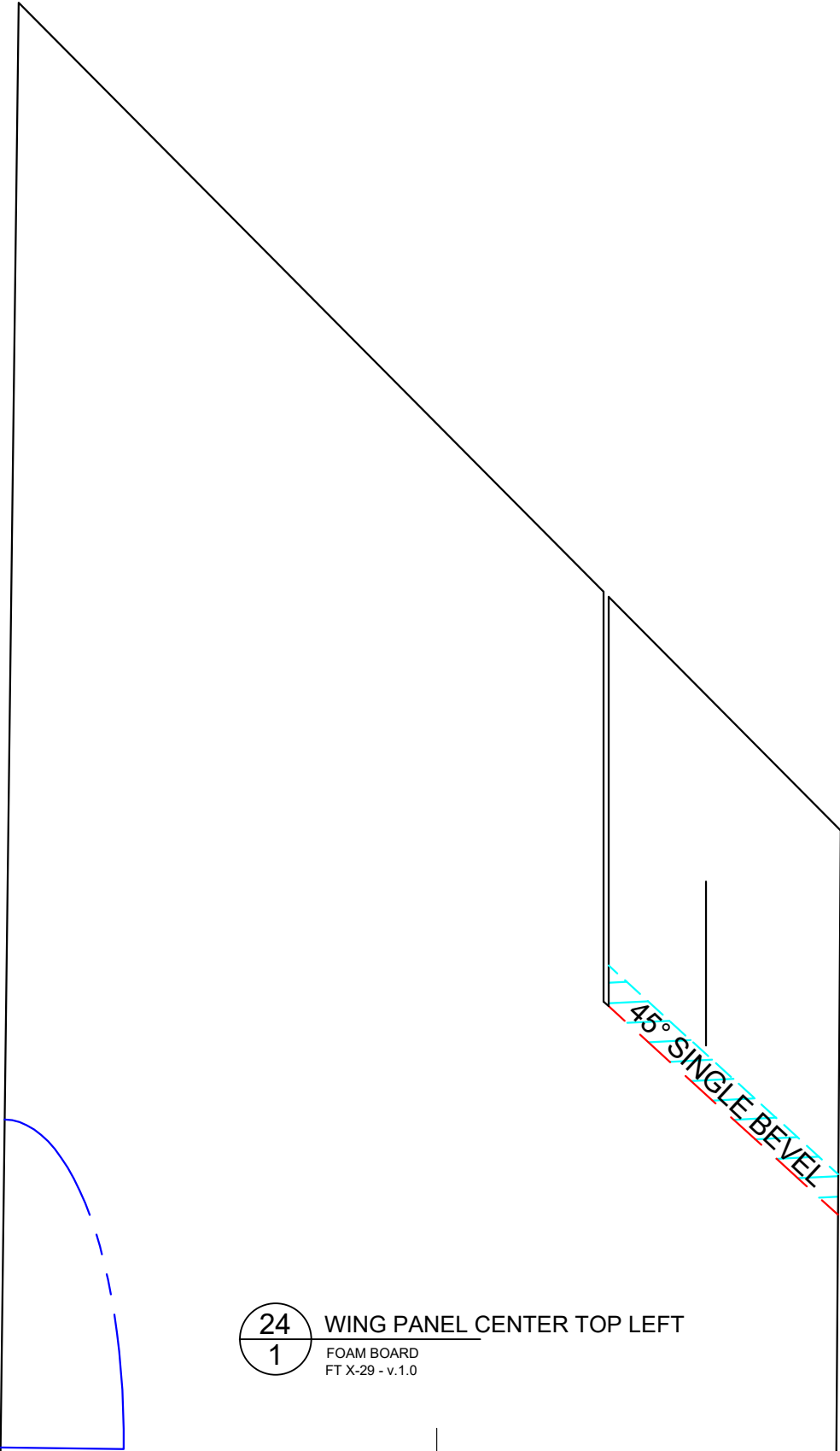

24
1

WING PANEL CENTER TOP LEFT

FOAM BOARD
FT X-29 - v.1.0



IN
CM

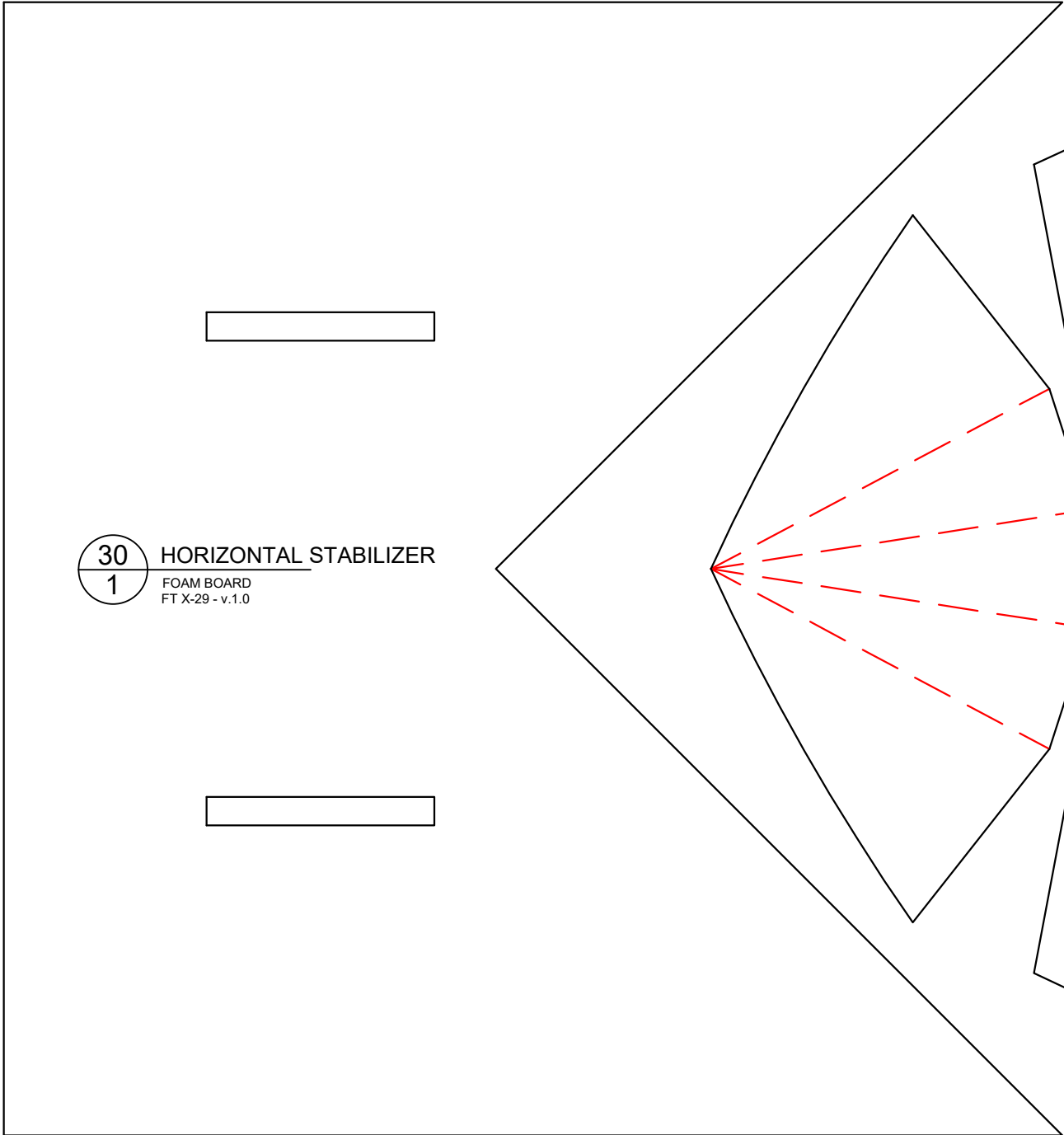

30
1

HORIZONTAL STABILIZER

FOAM BOARD
FT X-29 - v.1.0

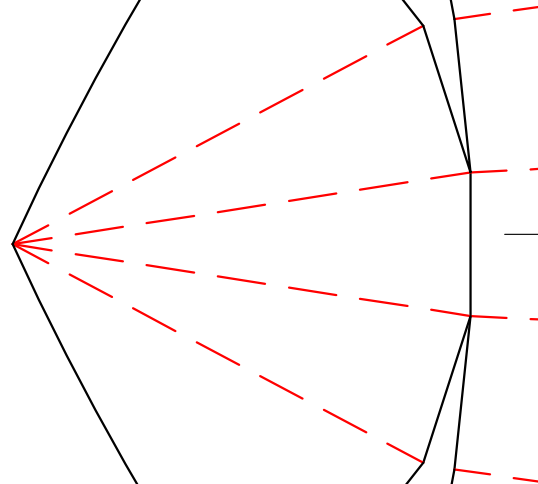



IN
CM

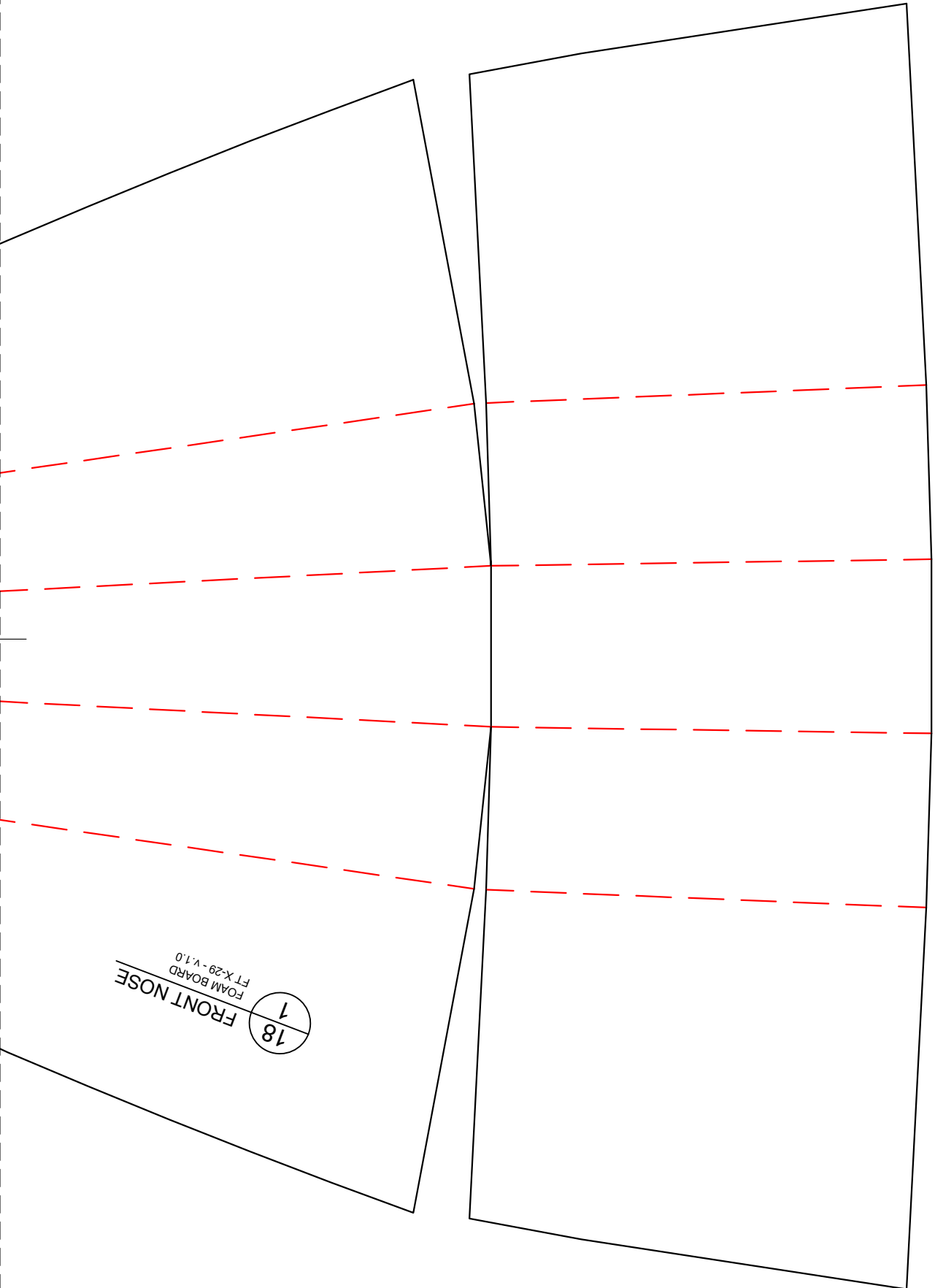

FRONT NOSE

18

FOAM BOARD
FT X-29 - V.1.0

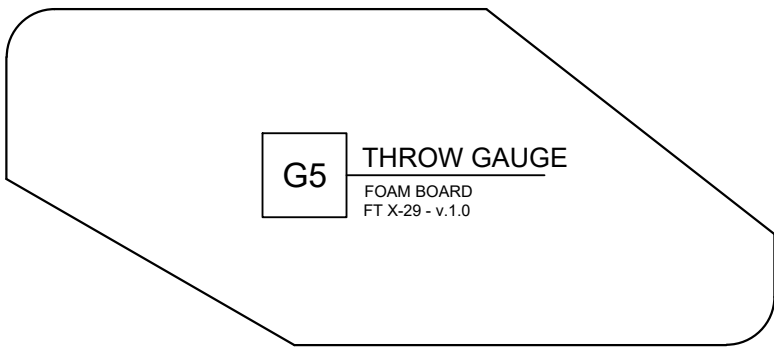
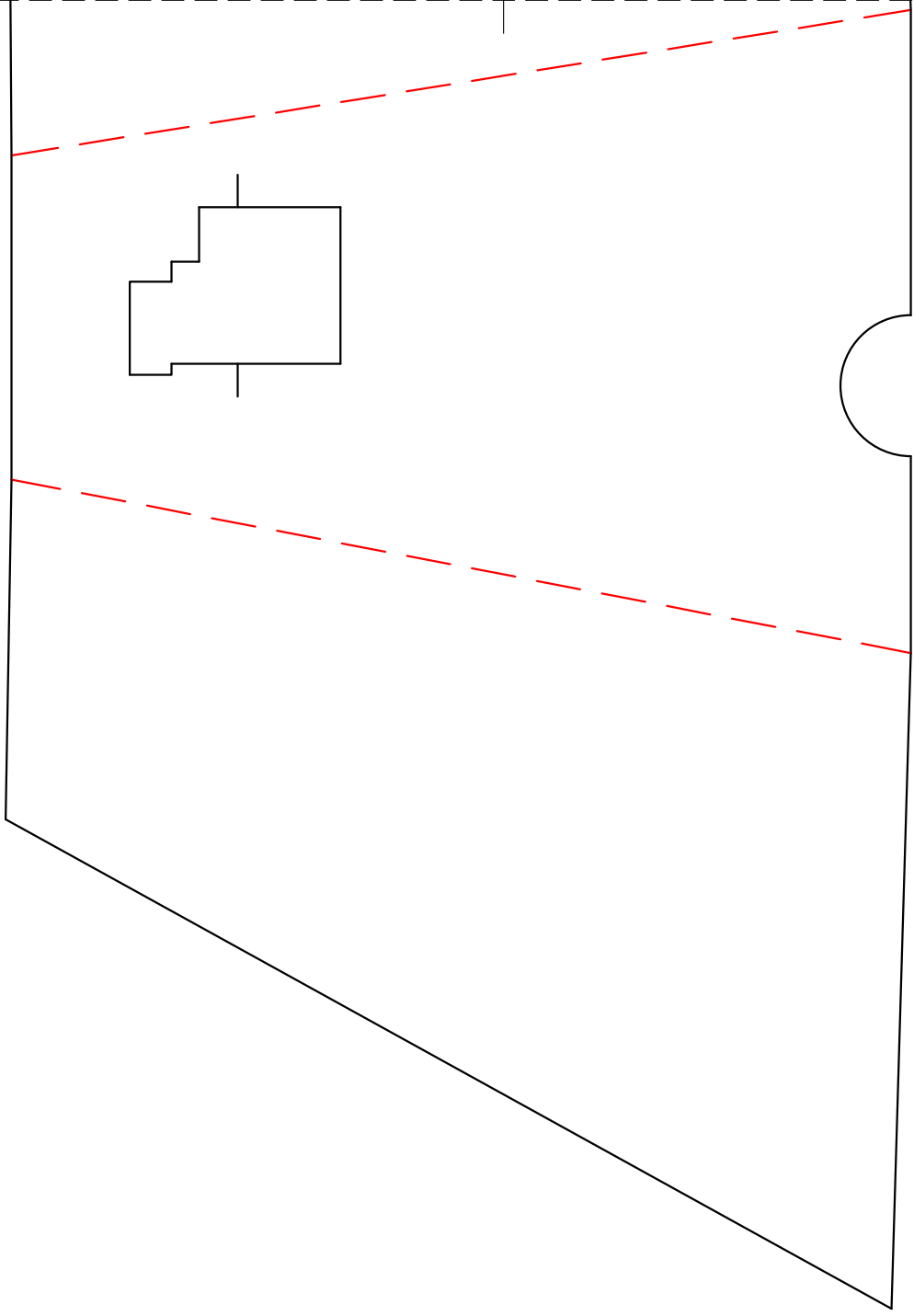

G5

THROW GAUGE

FOAM BOARD
FT X-29 - v.1.0

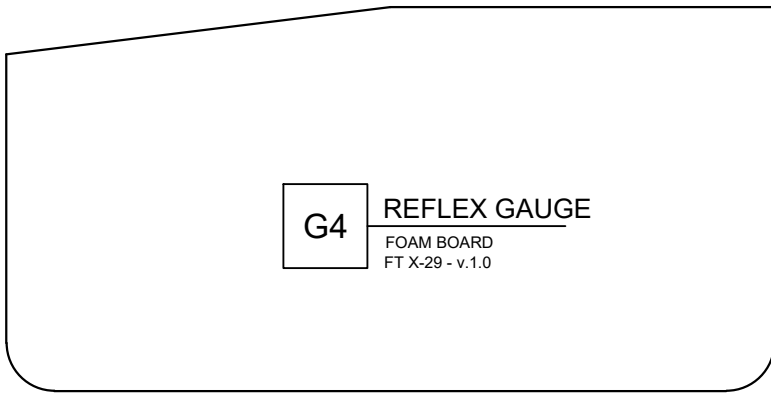
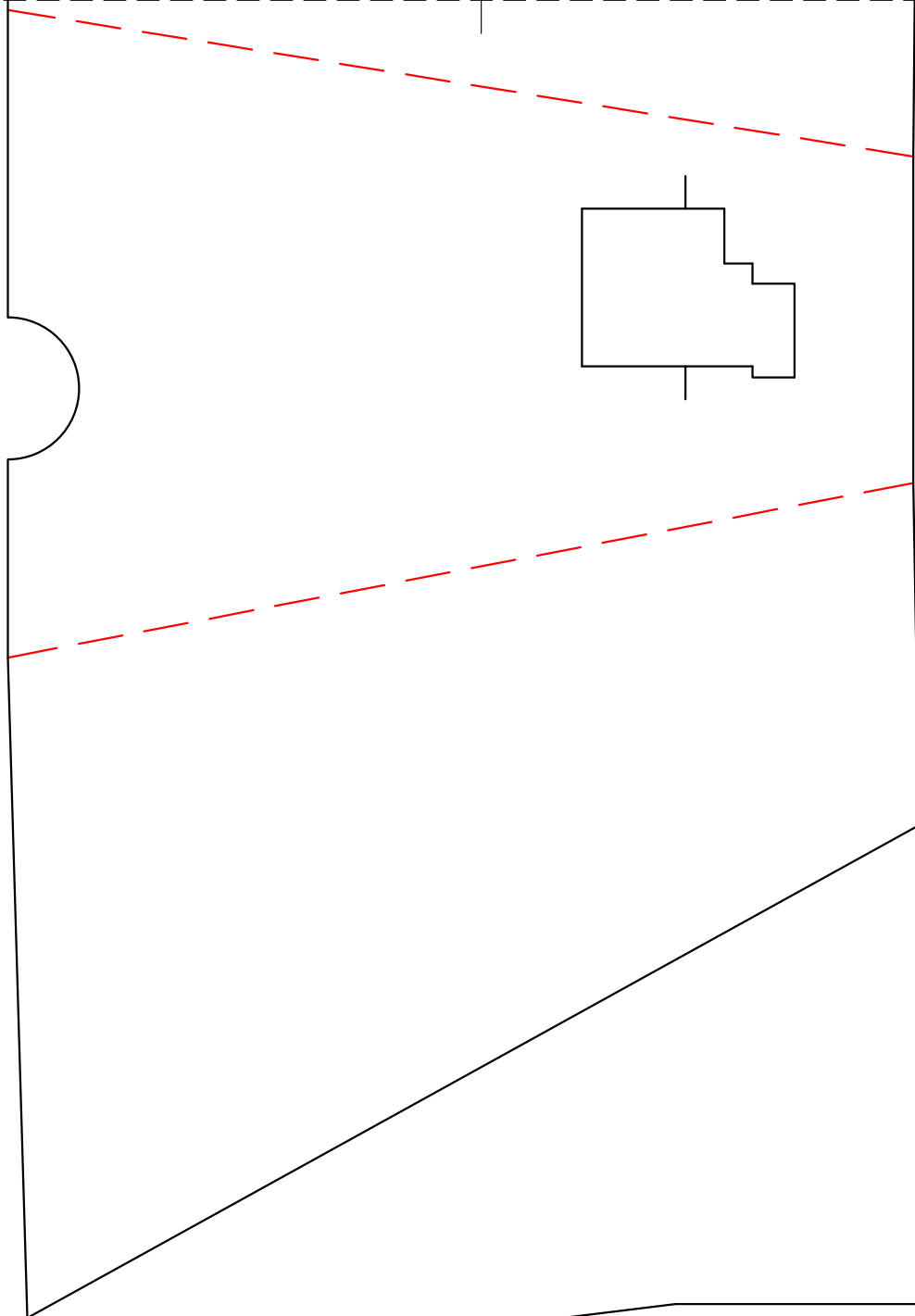

G4

REFLEX GAUGE

FOAM BOARD
FT X-29 - v.1.0



IN
CM



10 FUSELAGE CENTER/REAR
1 FOAM BOARD
FT X-29 - v.1.0

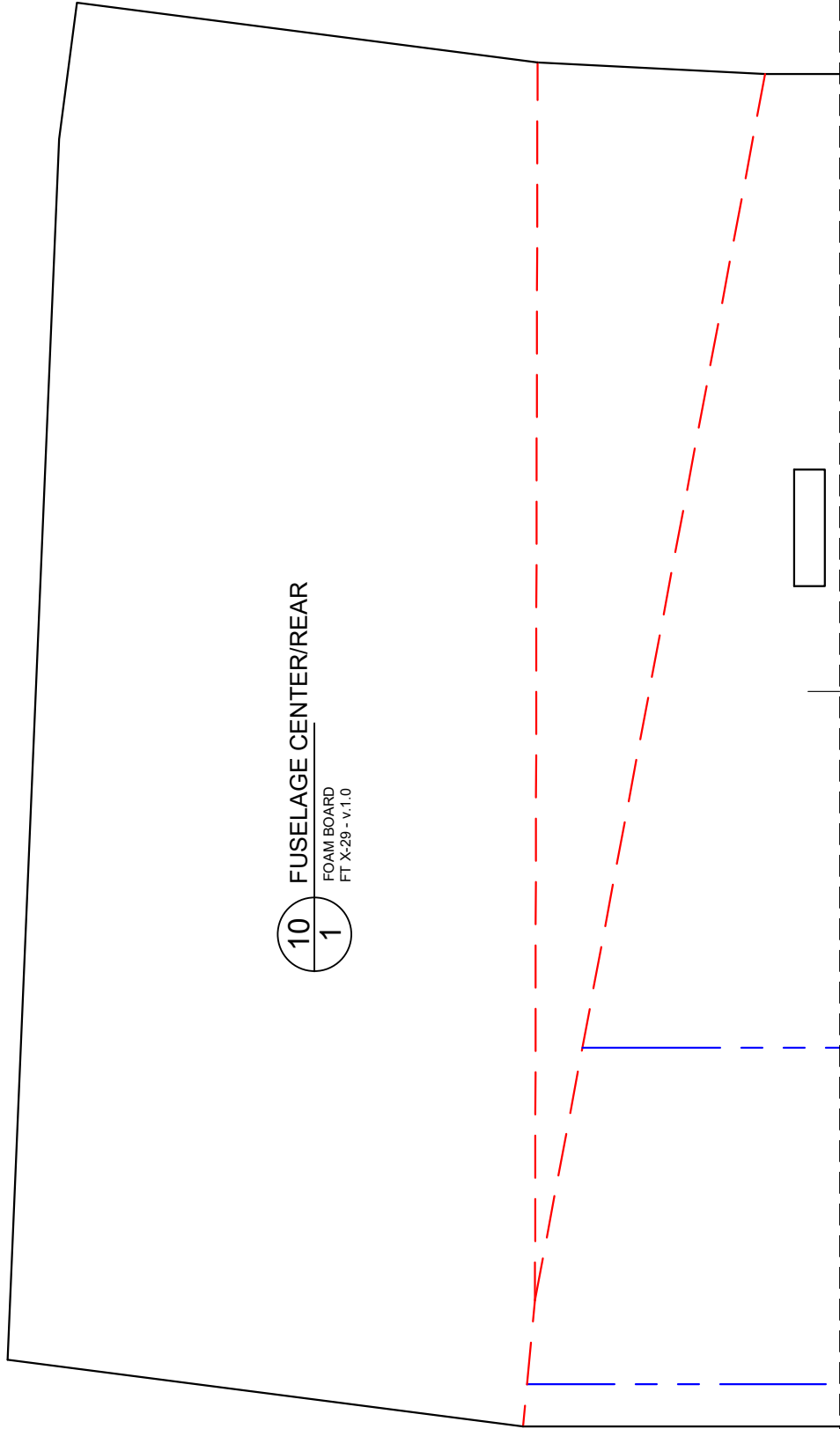



IN
CM



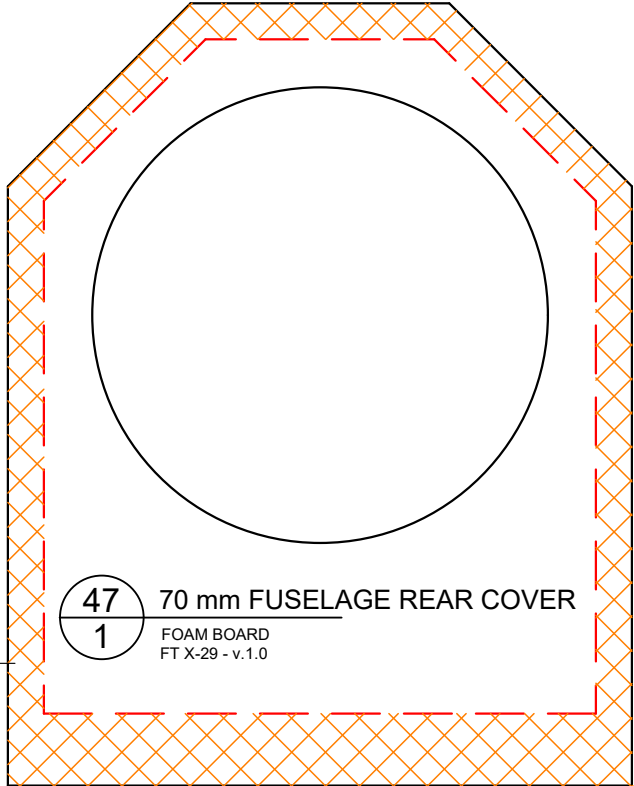

47 70 mm FUSELAGE REAR COVER
1 FOAM BOARD
FT X-29 - v.1.0

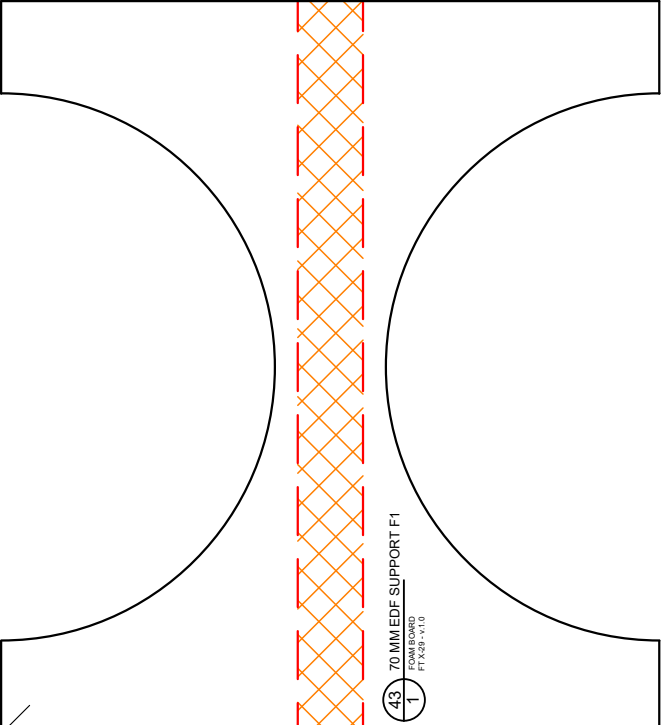

43 70 MM EDF SUPPORT F1
FOAM BOARD
FT X-29 - v.1.0
1

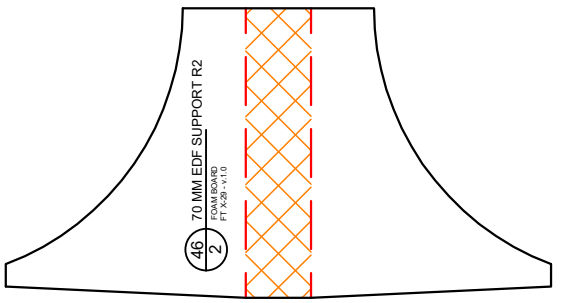

46 70 MM EDF SUPPORT R2
FOAM BOARD
FT X-29 - v.1.0
2

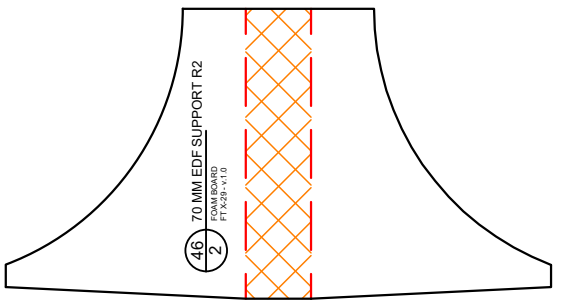

48 70 MM EDF SUPPORT R2
FOAM BOARD
FT X-29 - v.1.0
2

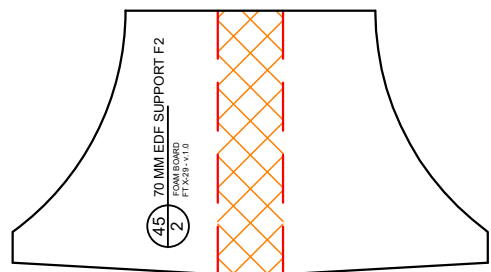

45 70 MM EDF SUPPORT F2
FOAM BOARD
FT X-29 - v.1.0
2

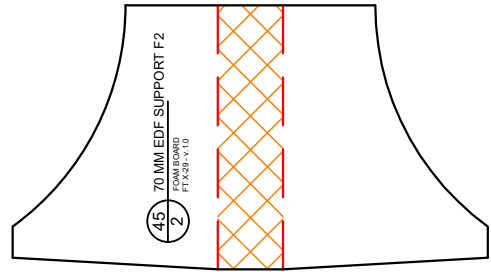

45 70 MM EDF SUPPORT F2
FOAM BOARD
FT X-29 - v.1.0
2

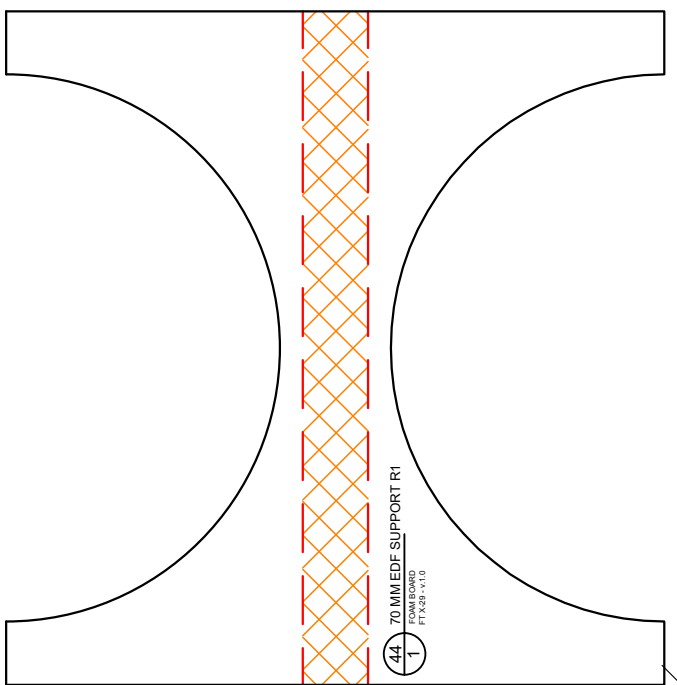

44 70 MM EDF SUPPORT R1
FOAM BOARD
FT X-29 - v.1.0
1

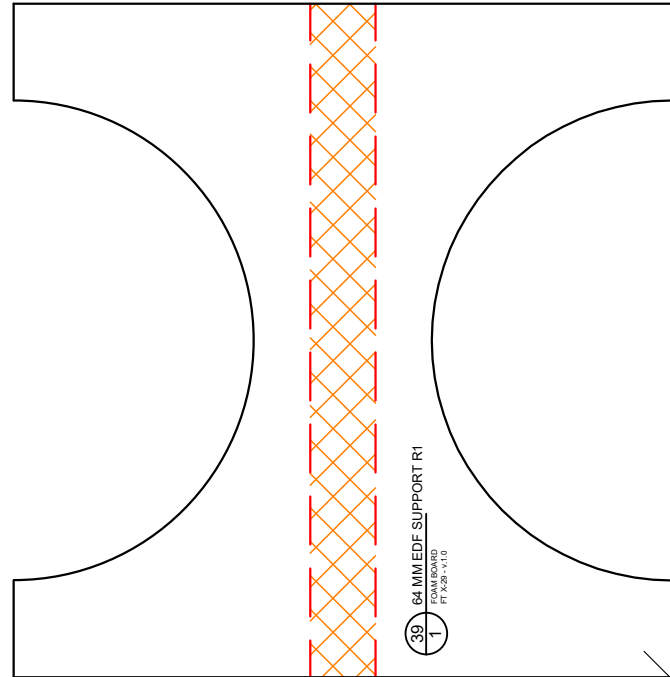
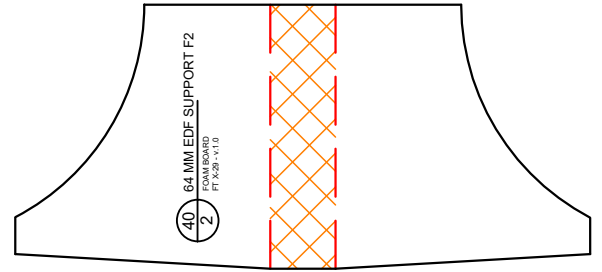
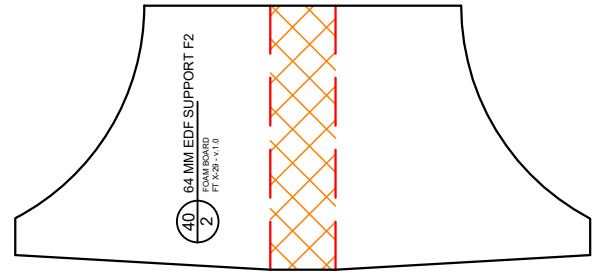
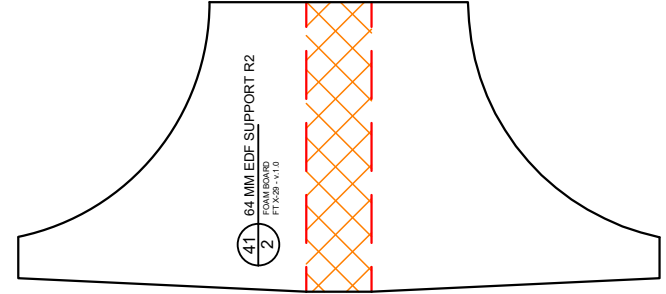
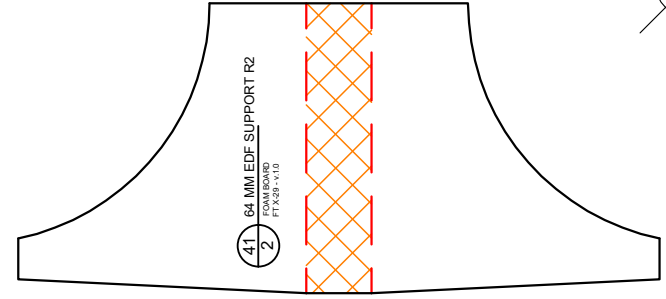
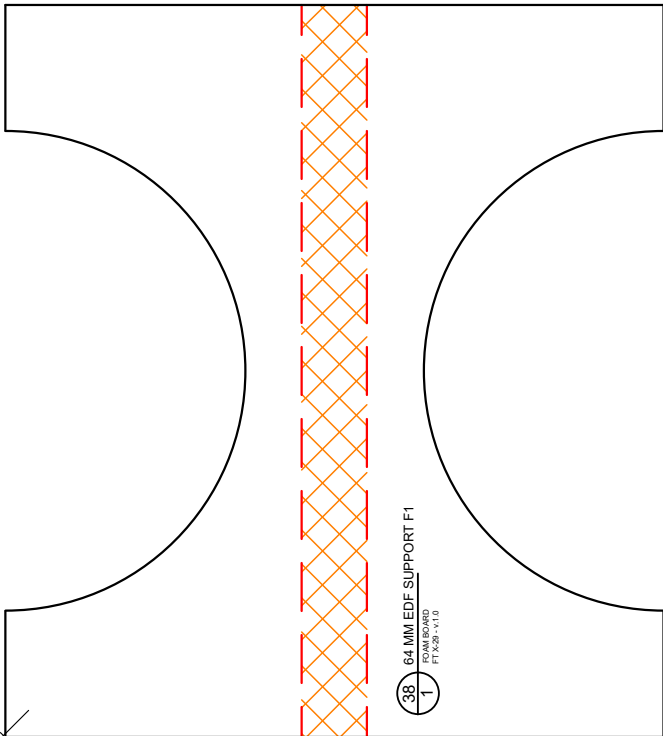
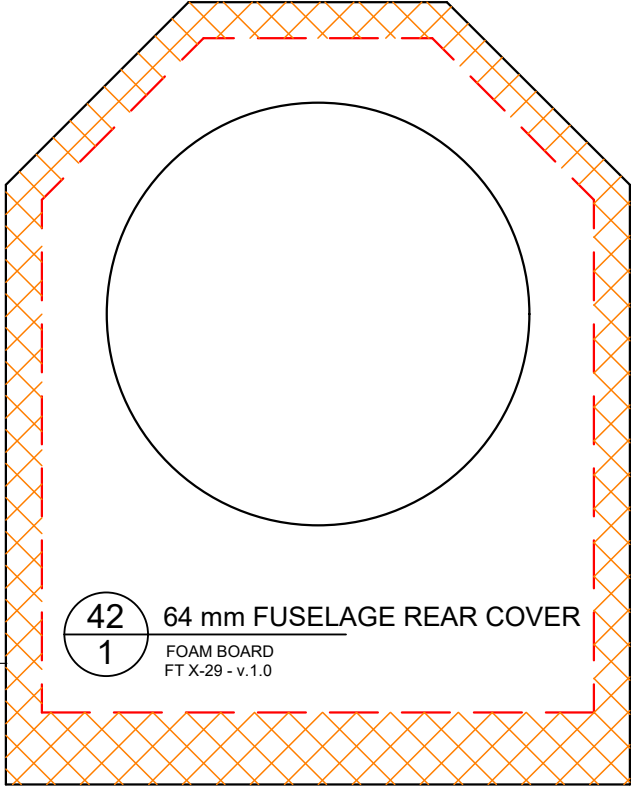



IN
CM

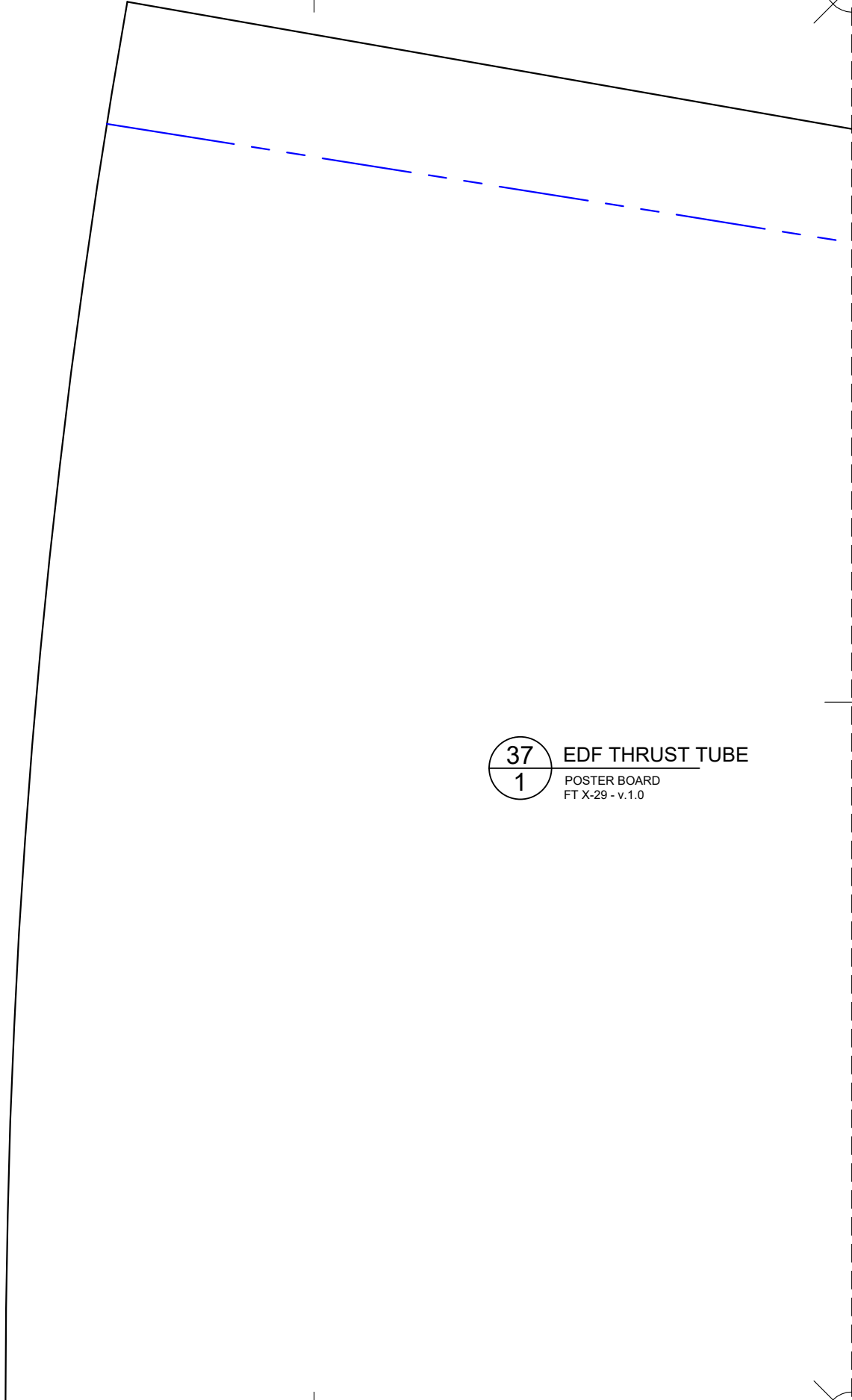

37
1

EDF THRUST TUBE

POSTER BOARD
FT X-29 - v.1.0



IN
CM

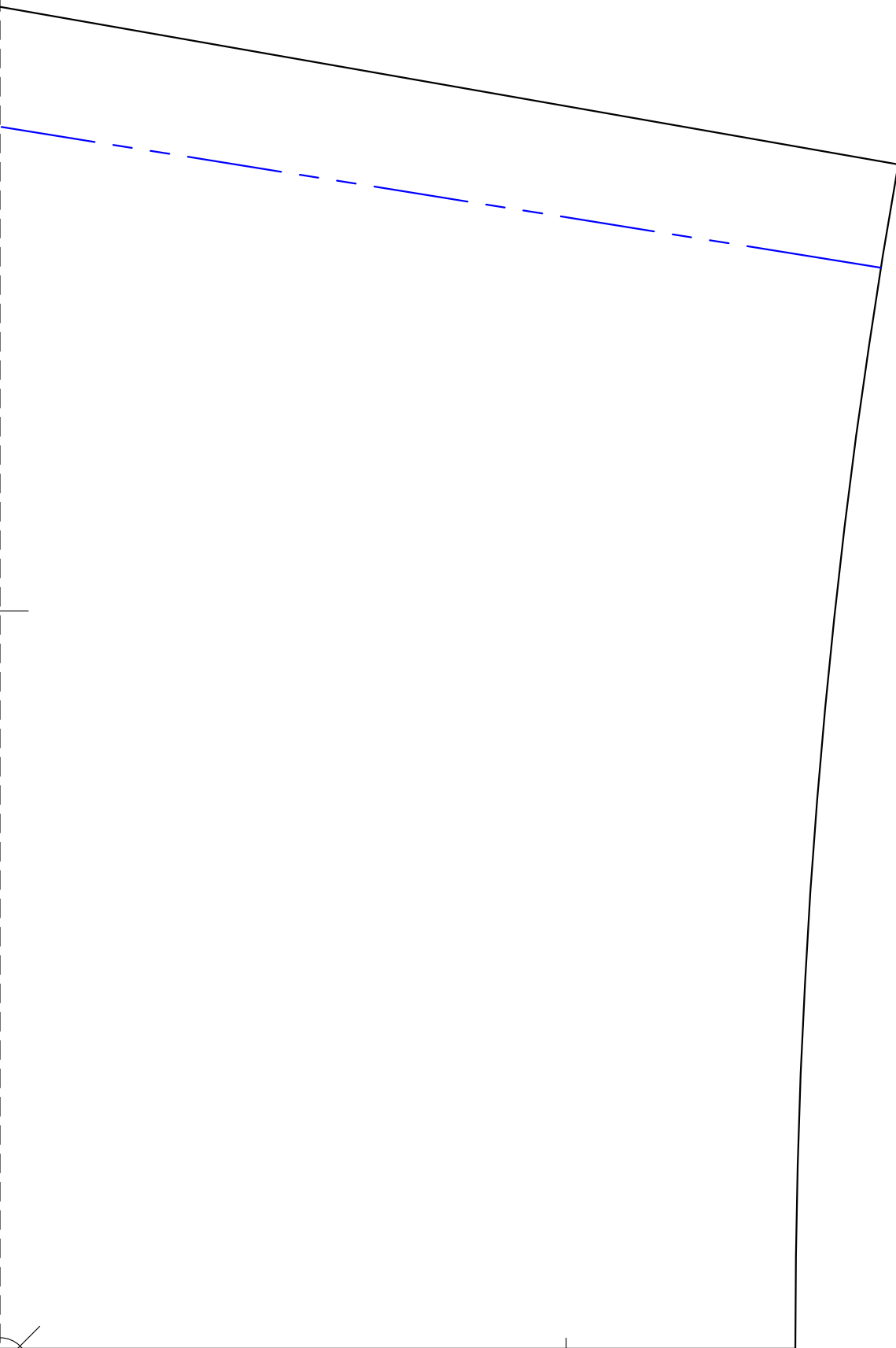

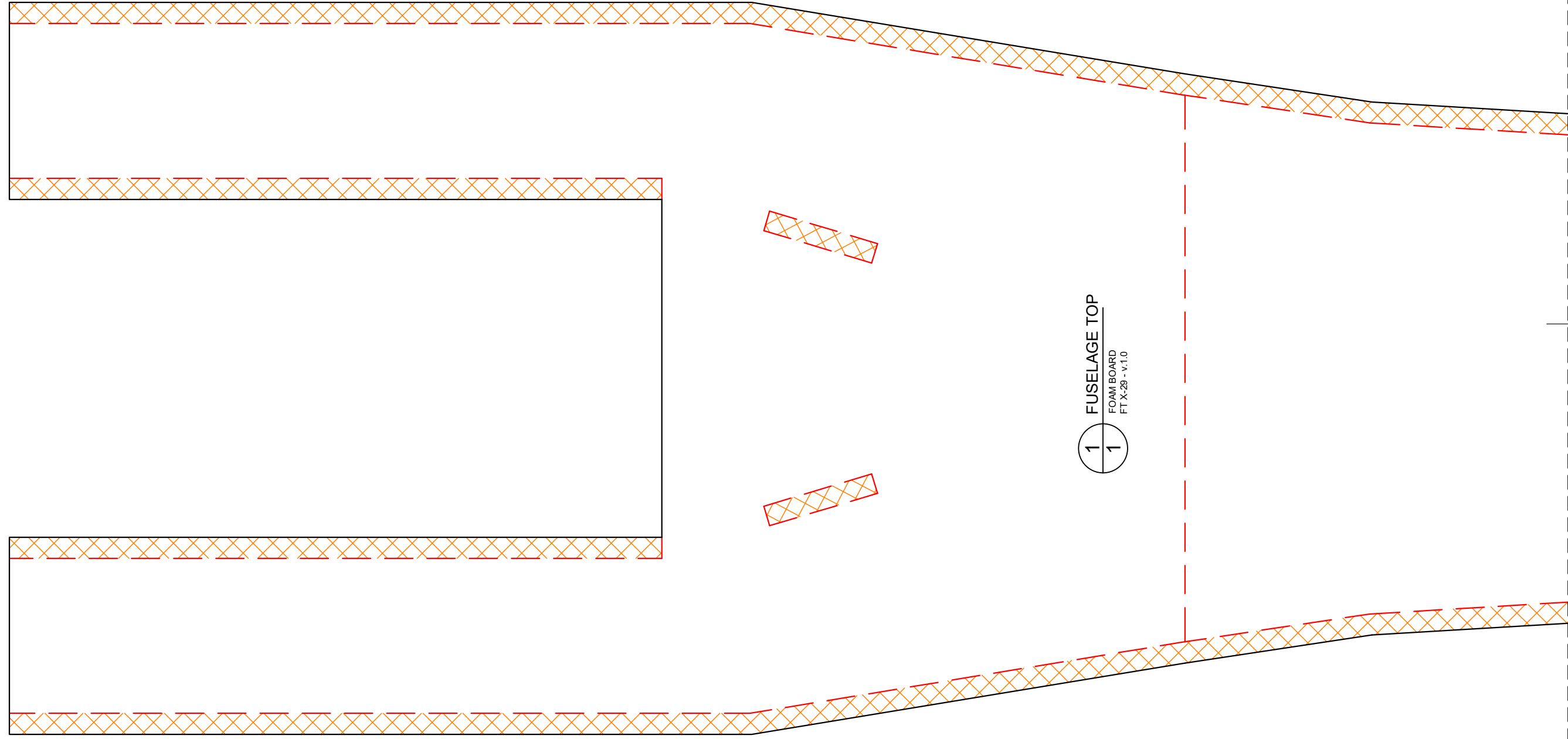

1 FUSELAGE TOP
1 FOAM BOARD
FT X-29 - v.1.0



IN
CM

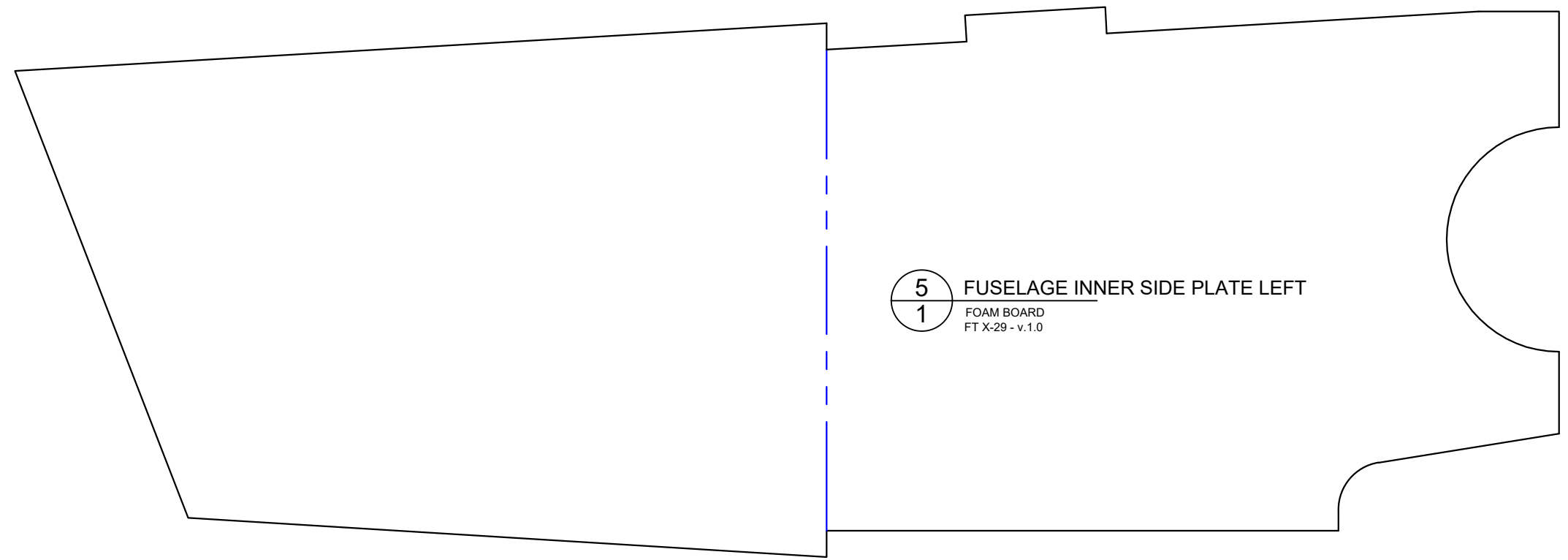

5 FUSELAGE INNER SIDE PLATE LEFT
1 FOAM BOARD
FT X-29 - v.1.0

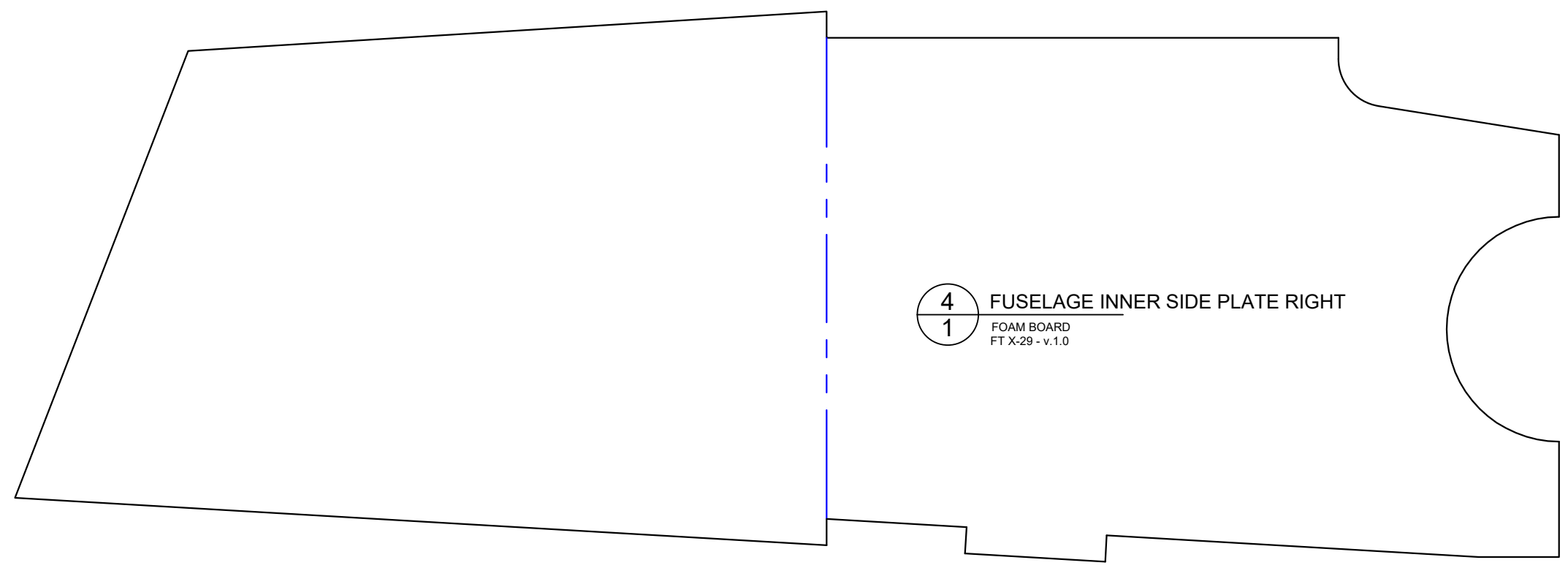

4 FUSELAGE INNER SIDE PLATE RIGHT
1 FOAM BOARD
FT X-29 - v.1.0

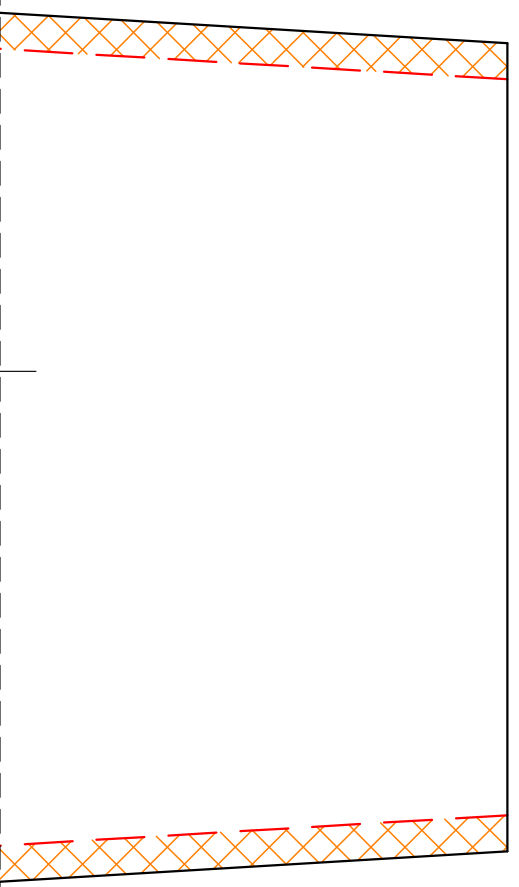

20
1

CENTER WING BOTTOM PLATE

FOAM BOARD
FT X-29 - v.1.0

2 FUSELAGE OUTER SIDE PLATE RIGHT
1 FOAM BOARD
FT X-29 - v.1.0

3 FUSELAGE OUTER SIDE PLATE LEFT
1 FOAM BOARD
FT X-29 - v.1.0

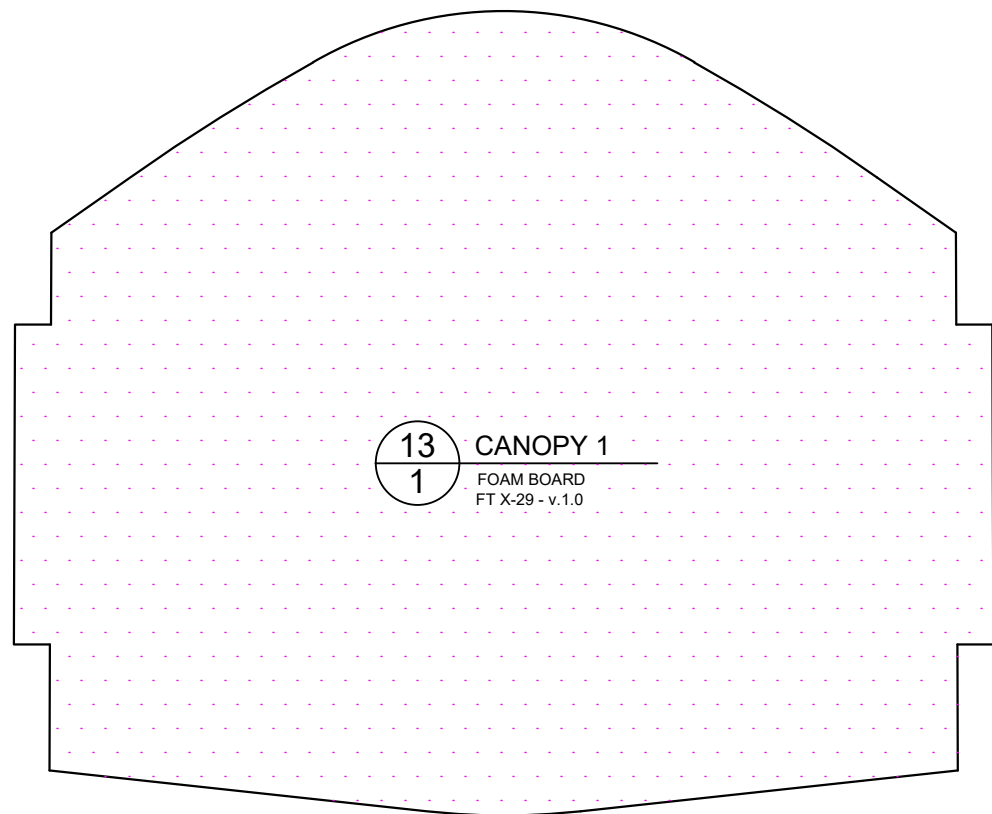

13
1 CANOPY 1
FOAM BOARD
FT X-29 - v.1.0

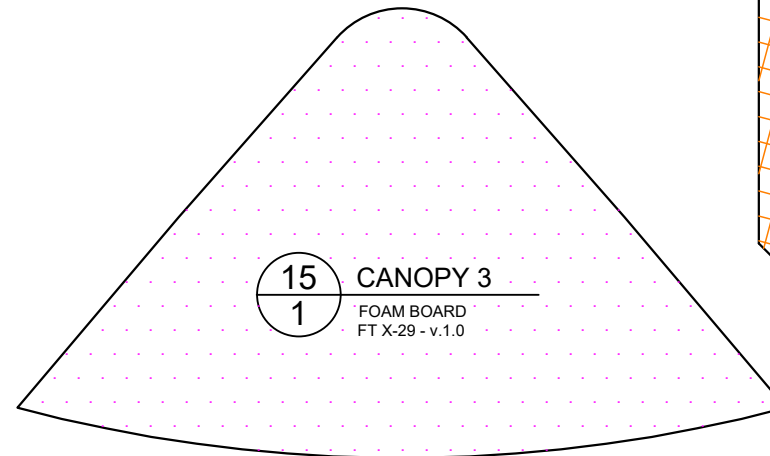

15
1 CANOPY 3
FOAM BOARD
FT X-29 - v.1.0

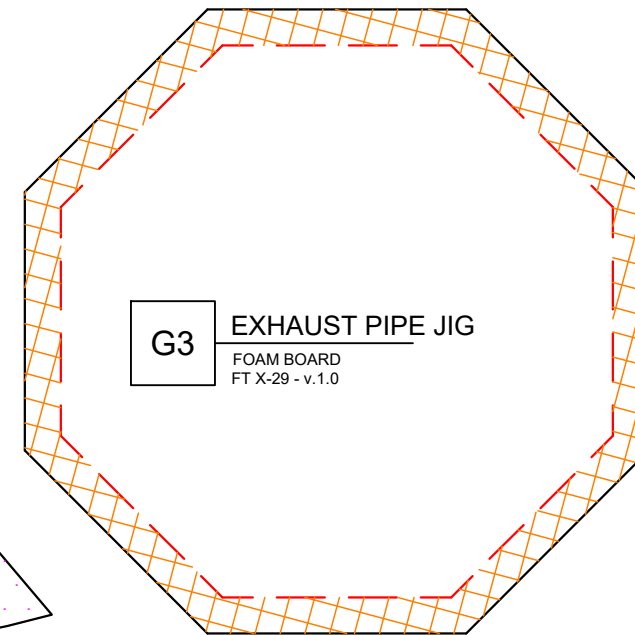

G3 EXHAUST PIPE JIG
FOAM BOARD
FT X-29 - v.1.0

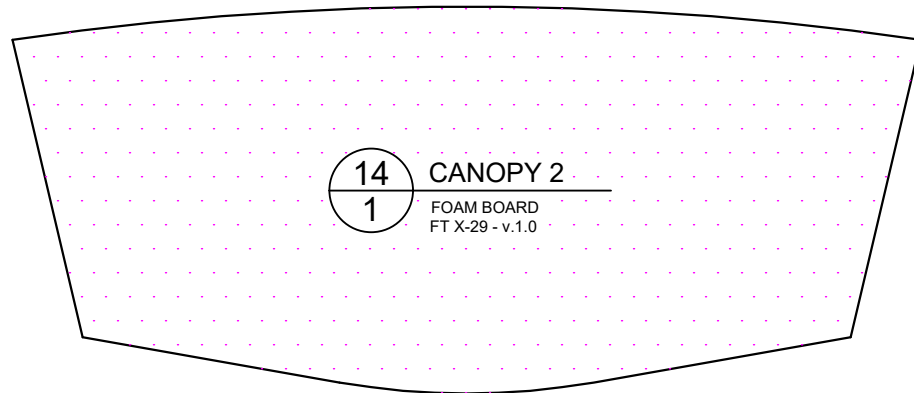

14
1 CANOPY 2
FOAM BOARD
FT X-29 - v.1.0

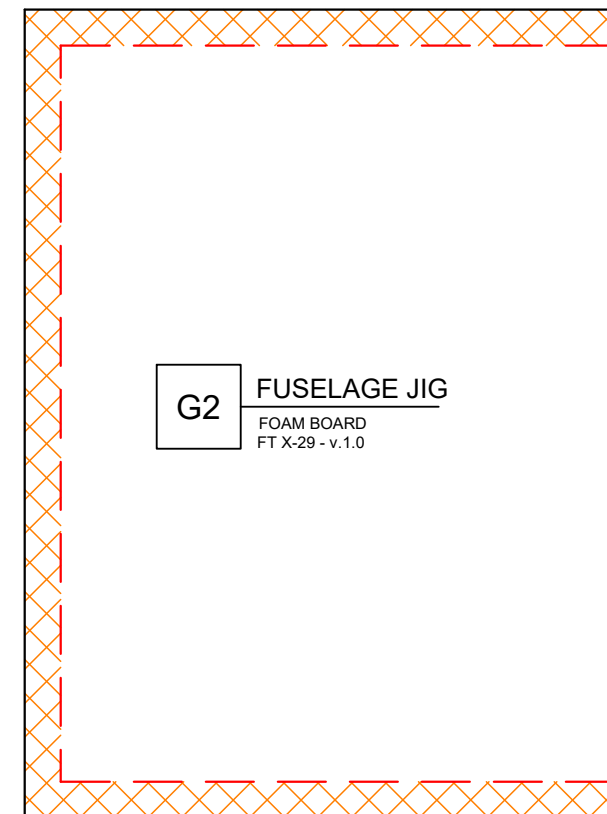

G2 FUSELAGE JIG
FOAM BOARD
FT X-29 - v.1.0

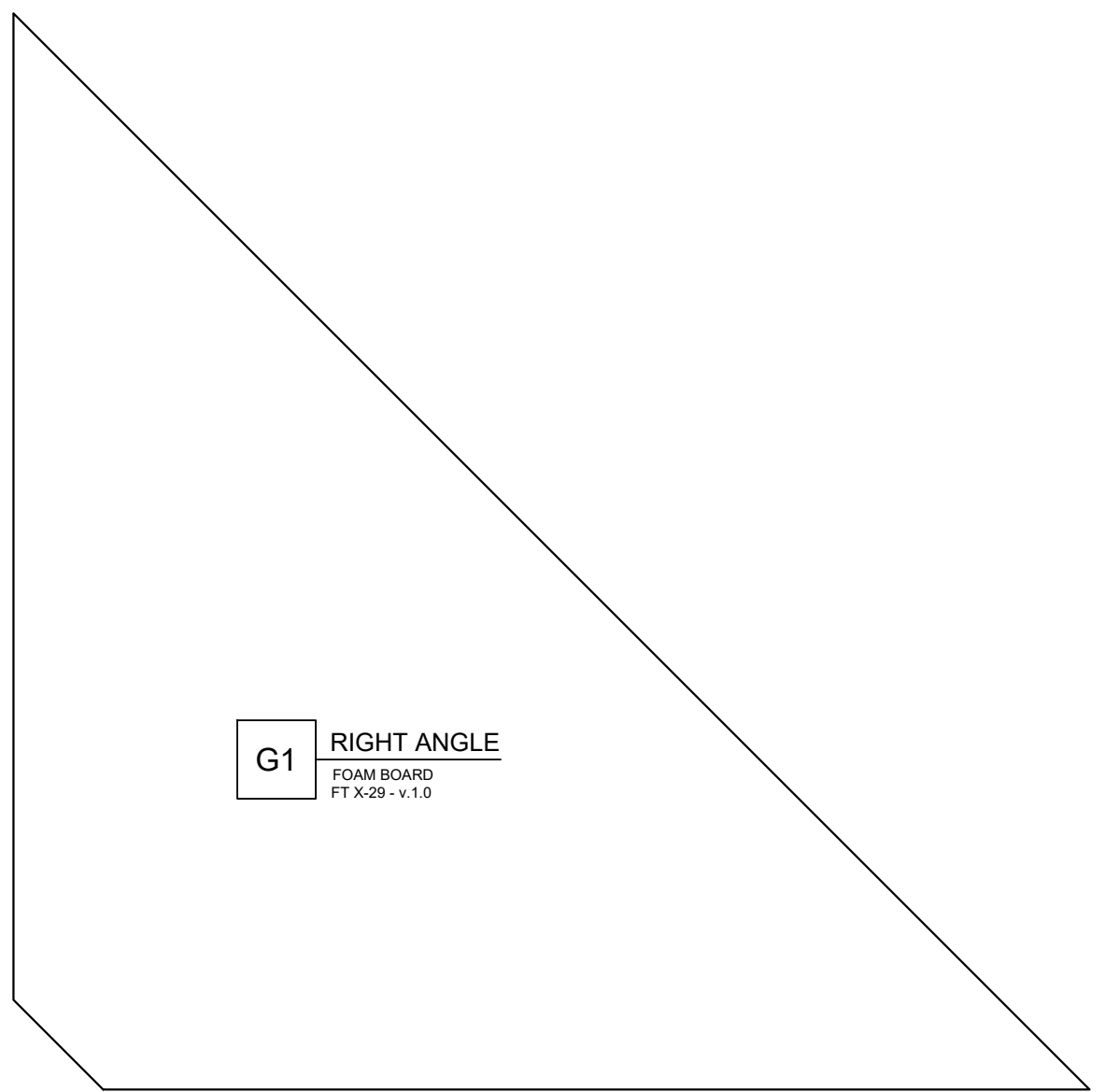
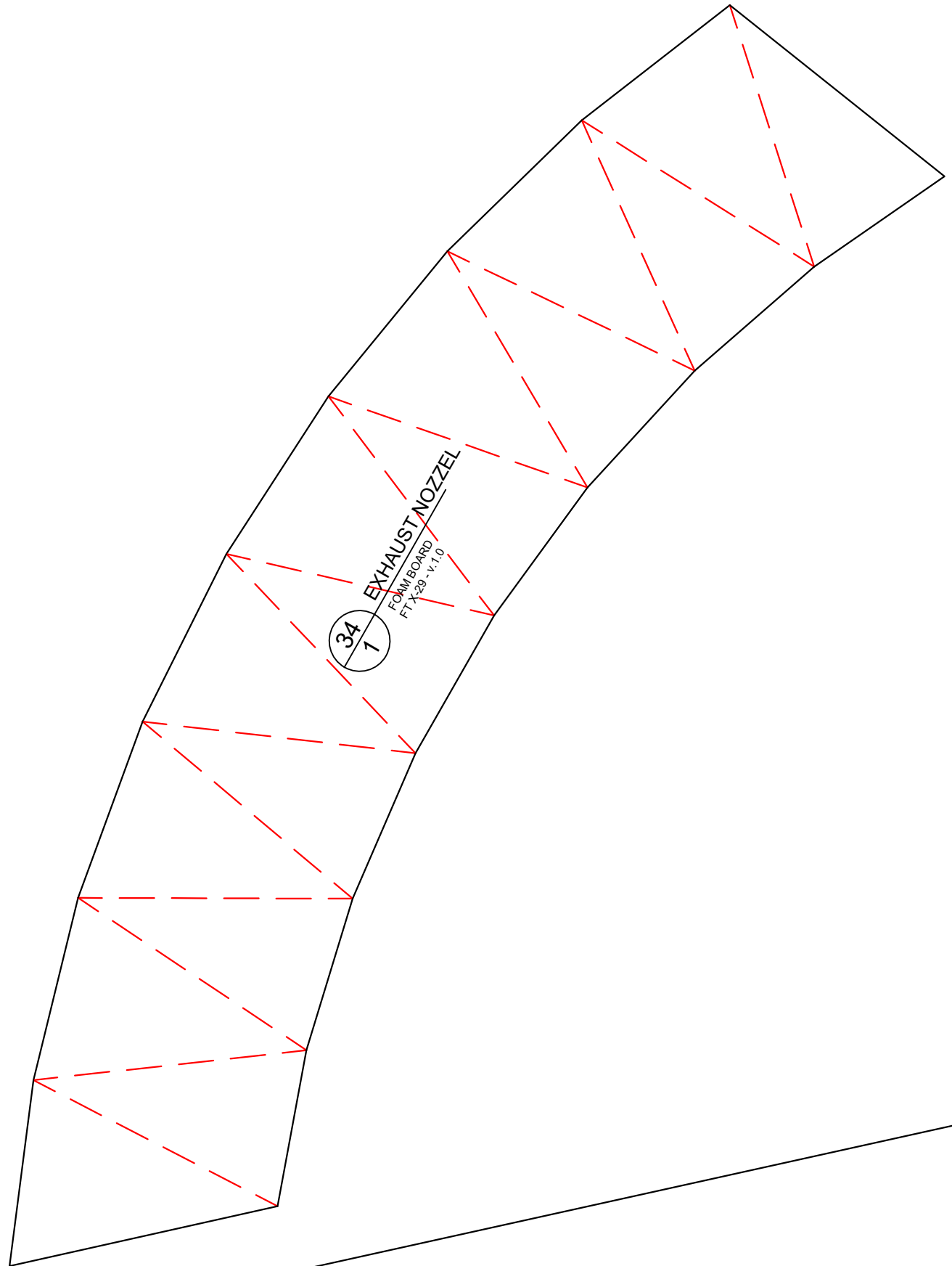

G1 RIGHT ANGLE
FOAM BOARD
FT X-29 - v.1.0

34
7

EXHAUST NOZZEL
FOAM BOARD
FT X-29 - v.1.0

22 WING PANEL LEFT
1 FOAM BOARD
FT X-29 - v.1.0

45° DOUBLE BEVEL

45° SINGLE BEVEL

27 WING SPAR OUTER
2 FOAM BOARD
FT X-29 - v.1.0

21 WING PANEL RIGHT
1 FOAM BOARD
FT X-29 - v.1.0

45° DOUBLE BEVEL

45° SINGLE BEVEL

27 WING SPAR OUTER
2 FOAM BOARD
FT X-29 - v.1.0

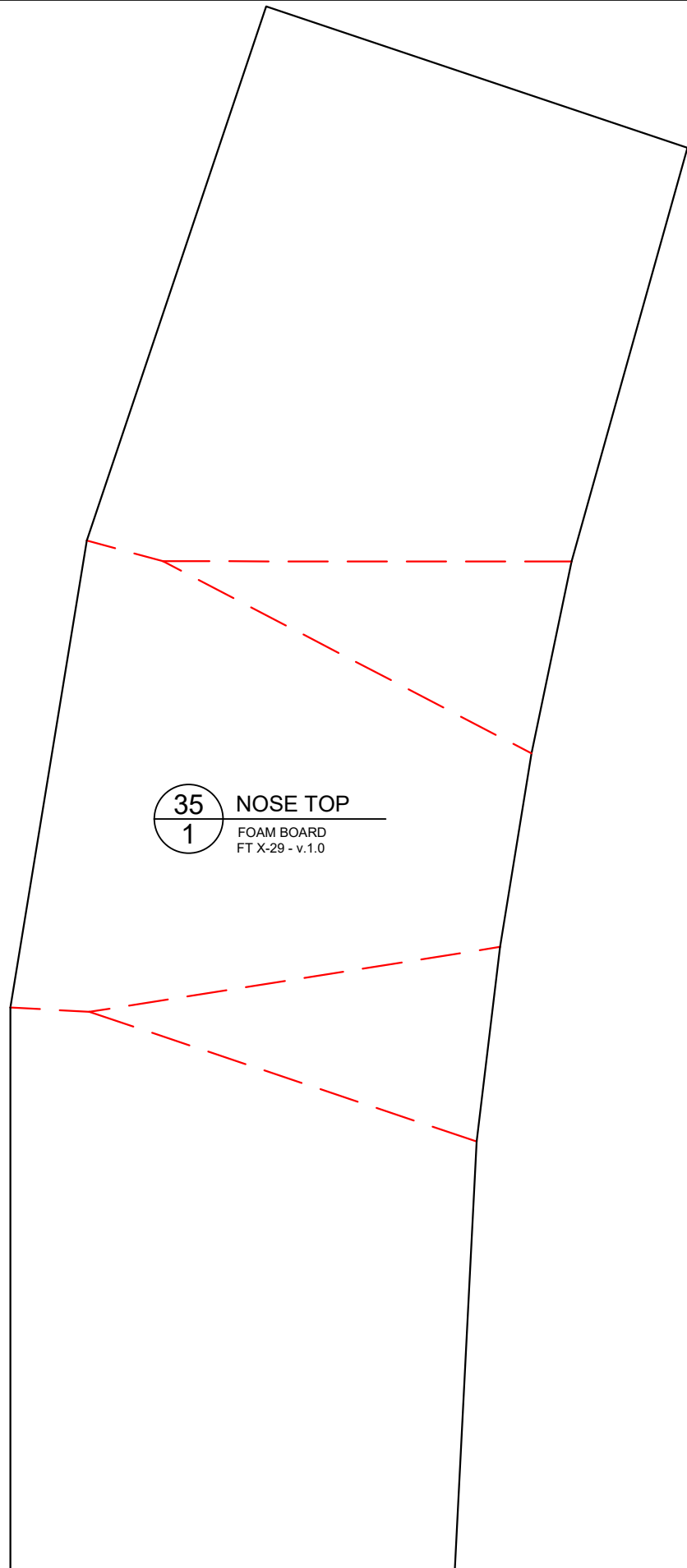

35
1

NOSE TOP
FOAM BOARD
FT X-29 - v.1.0

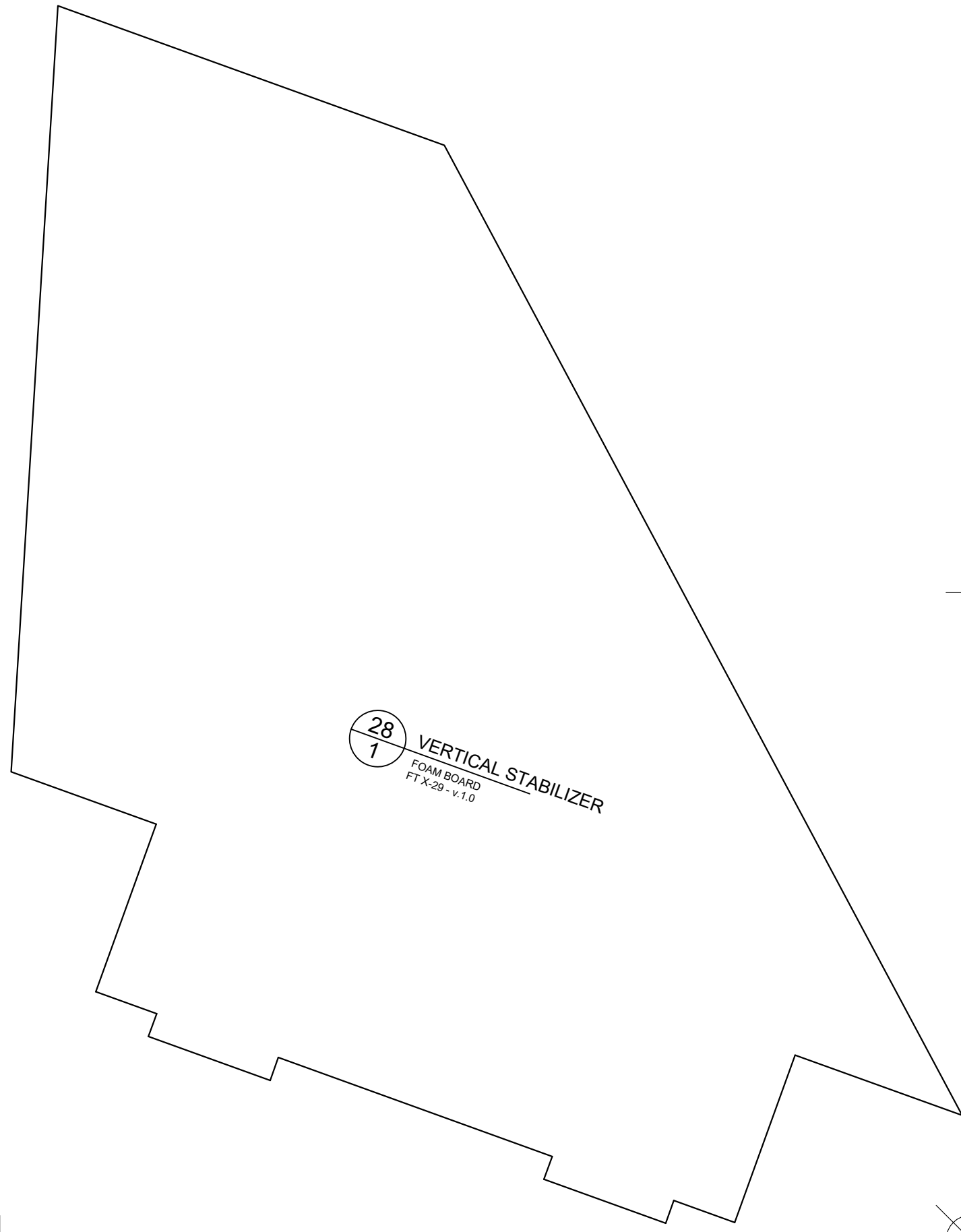

28
1

VERTICAL STABILIZER
FOAM BOARD
FT X-29 - v.1.0

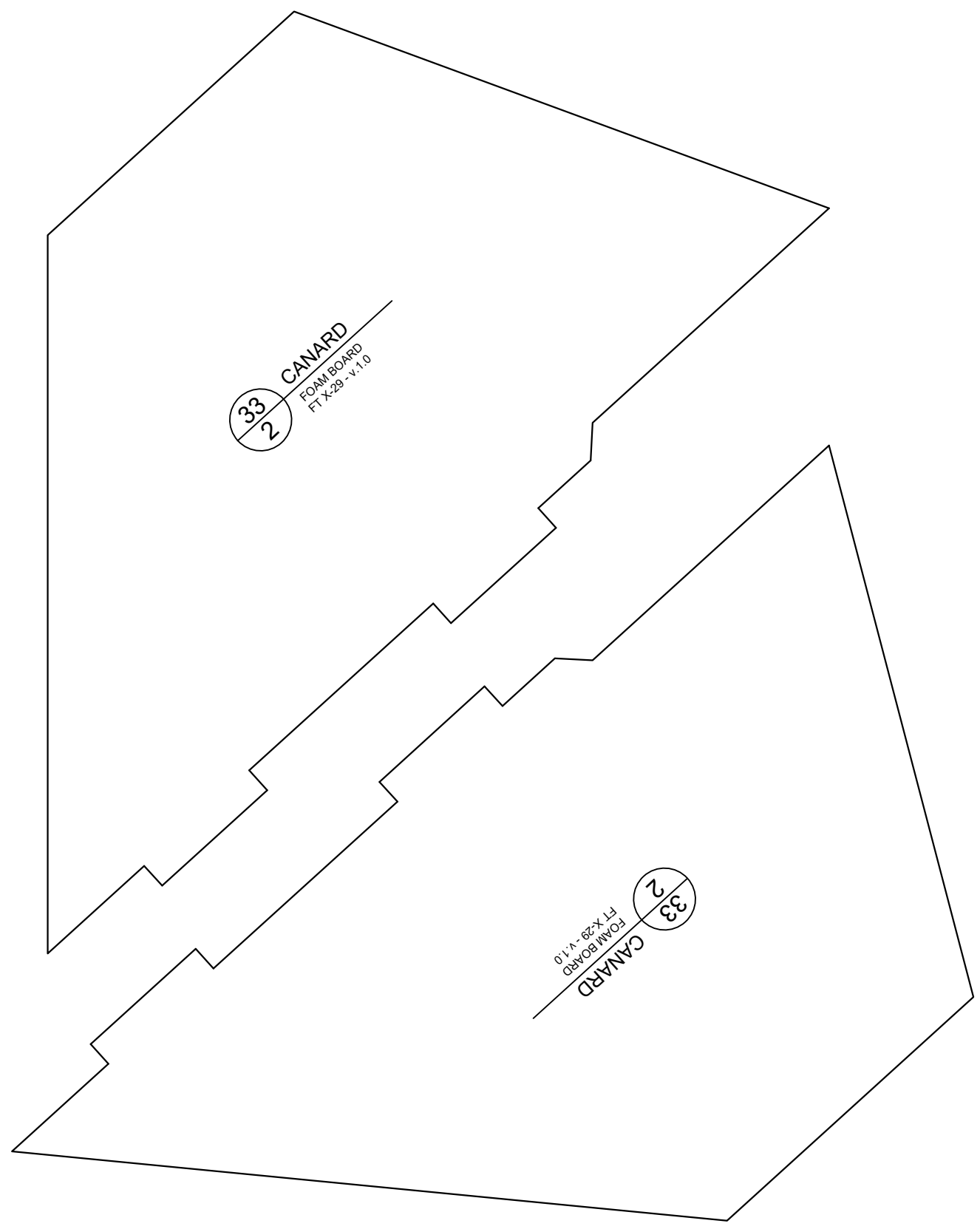
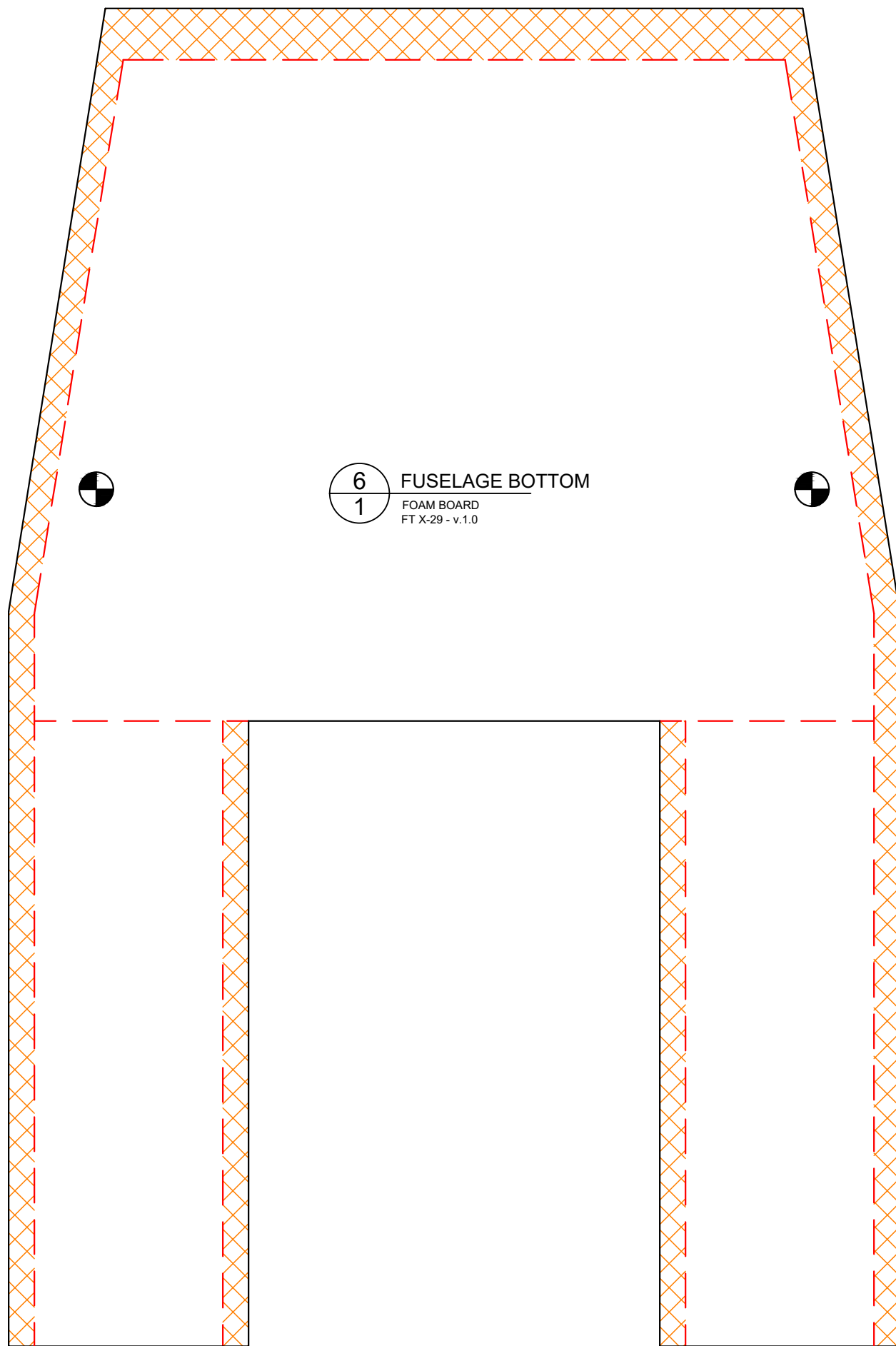

11
1
FOAM BOARD
FT X-29 - V.1.0
BOTTOM FUSELAGE COVER

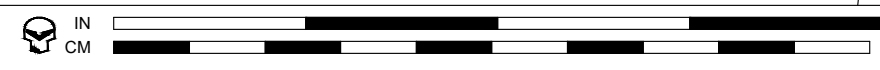

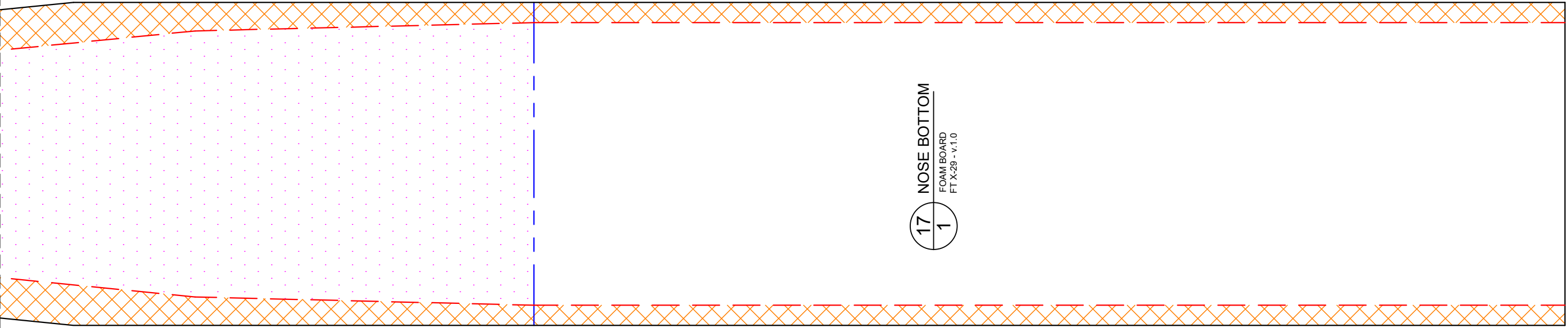

17
1
NOSE BOTTOM
FOAM BOARD
FT X-29 - V.1.0

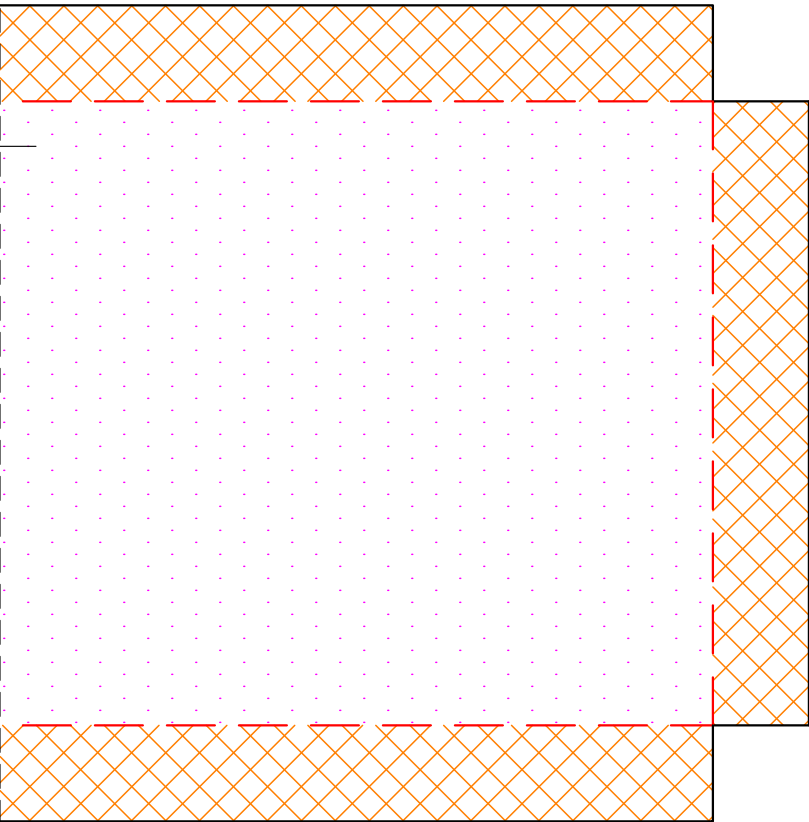

12
1
CANOPY FUSELAGE
FOAM BOARD
FT X-29 - V.1.0

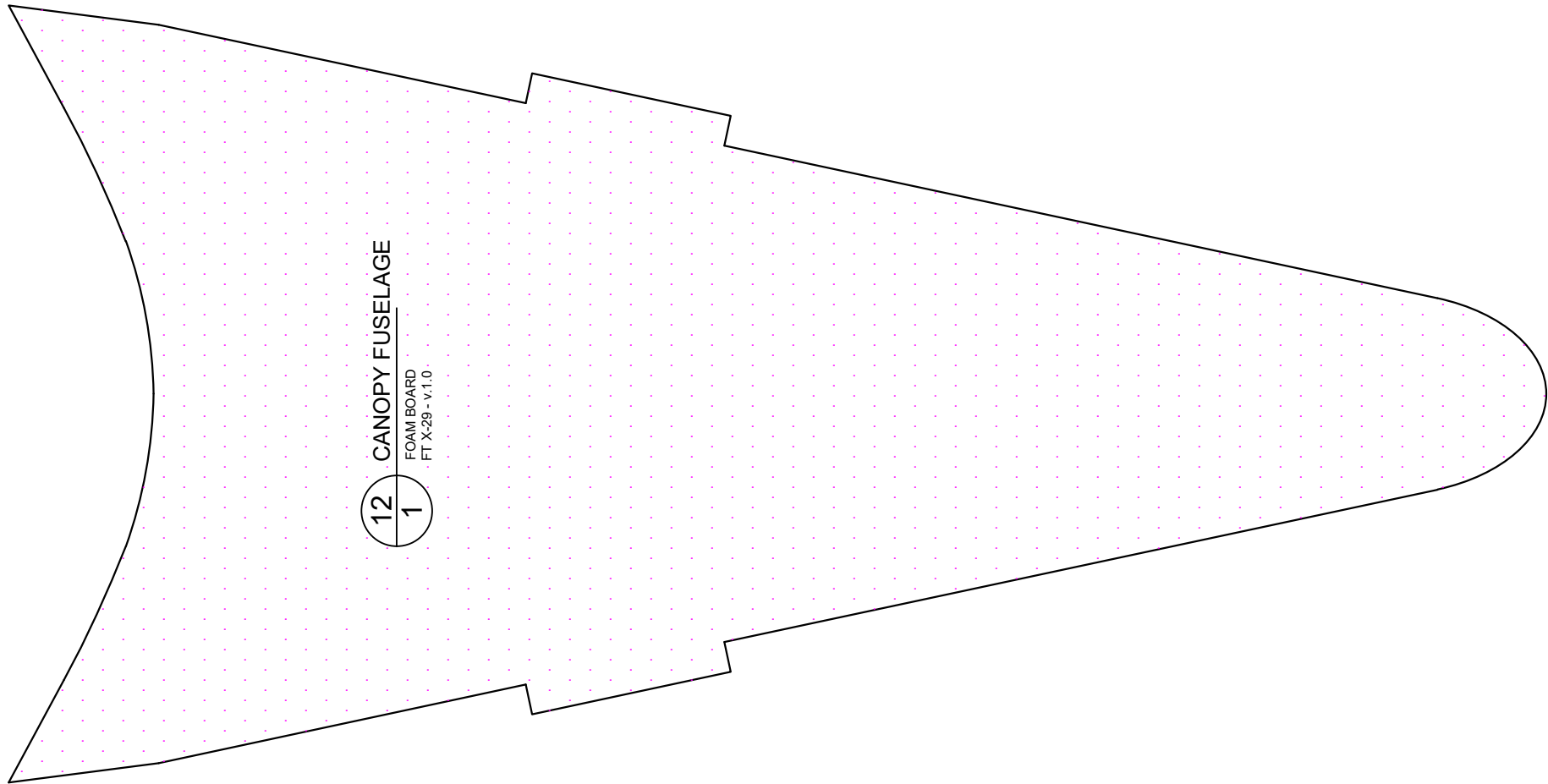

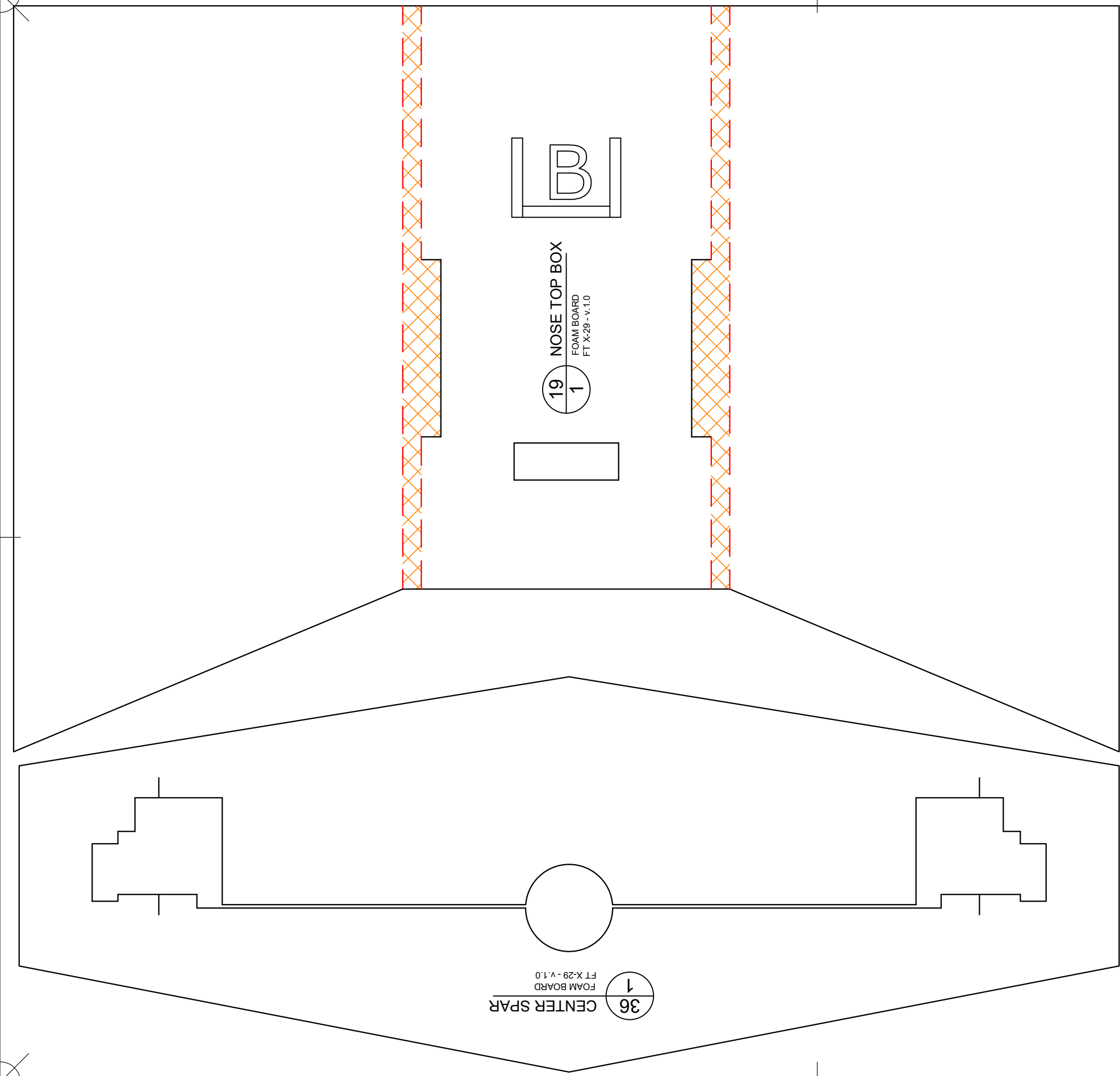

B

19 NOSE TOP BOX
FOAM BOARD
FT X-29 - v.1.0

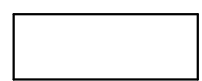

36 CENTER SPAR
FOAM BOARD
FT X-29 - v.1.0

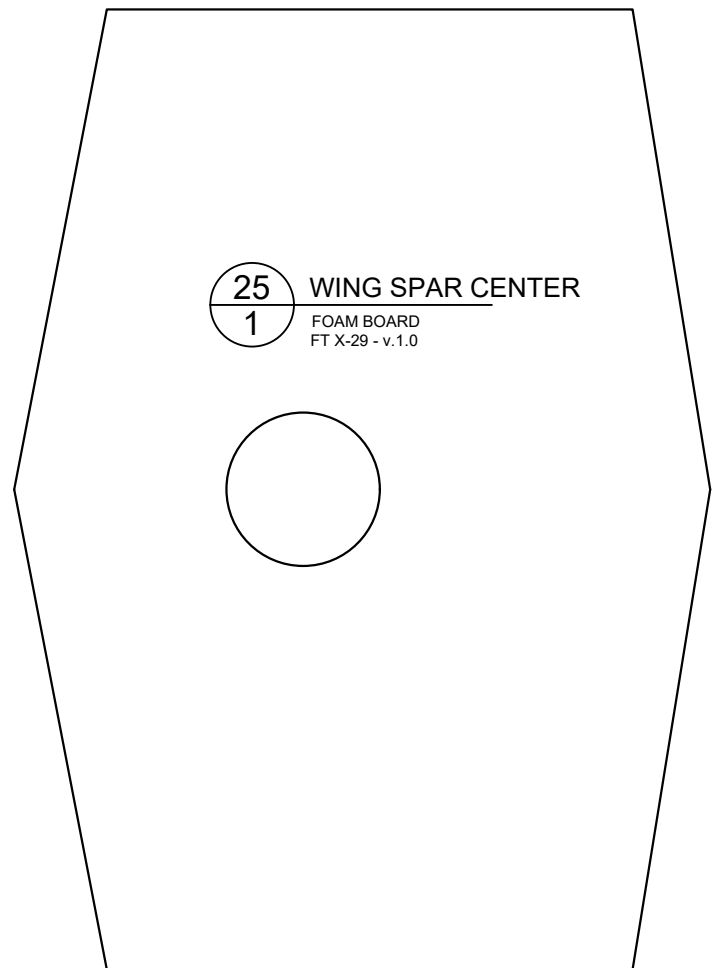

25 WING SPAR CENTER
FOAM BOARD
FT X-29 - v.1.0

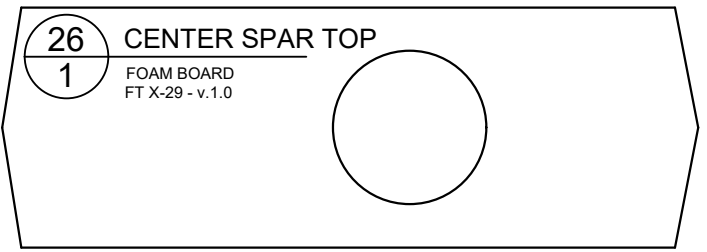

26 CENTER SPAR TOP
FOAM BOARD
FT X-29 - v.1.0

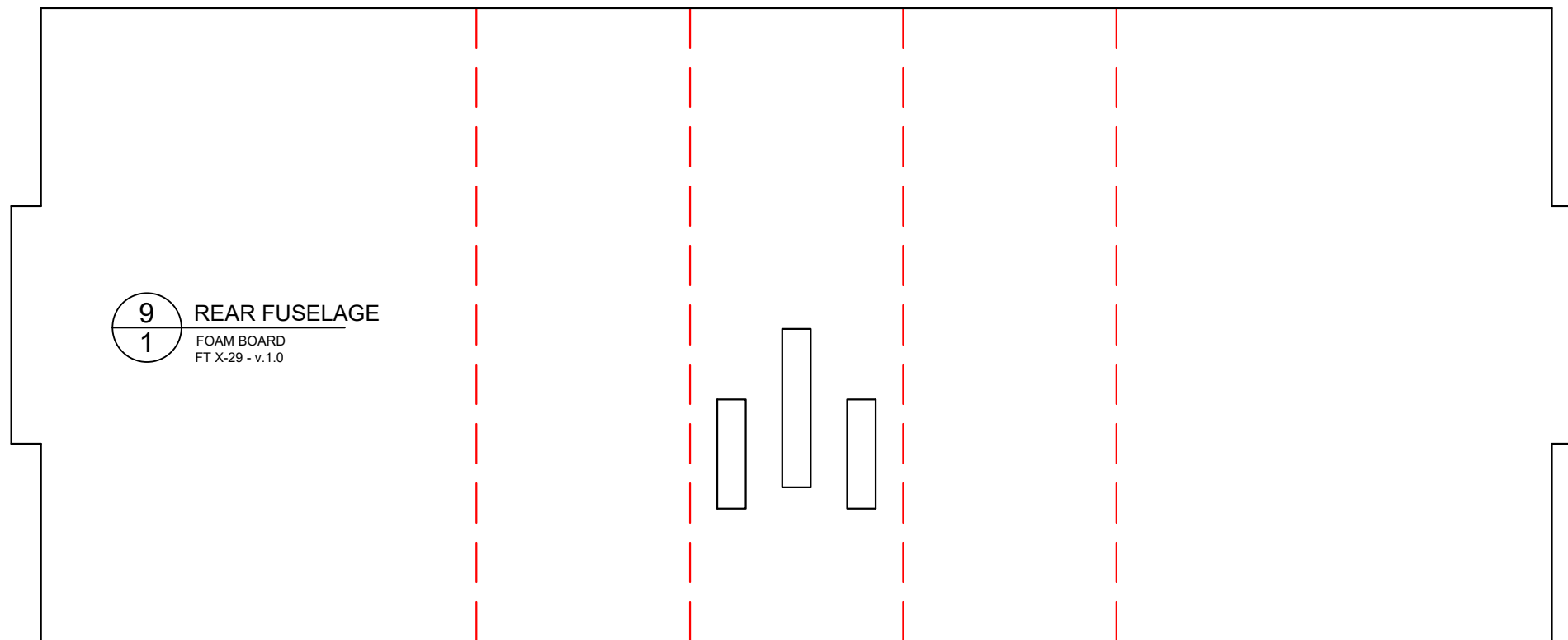
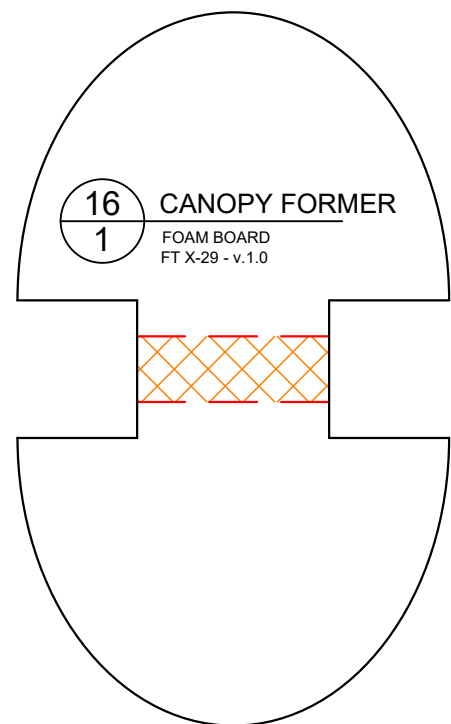
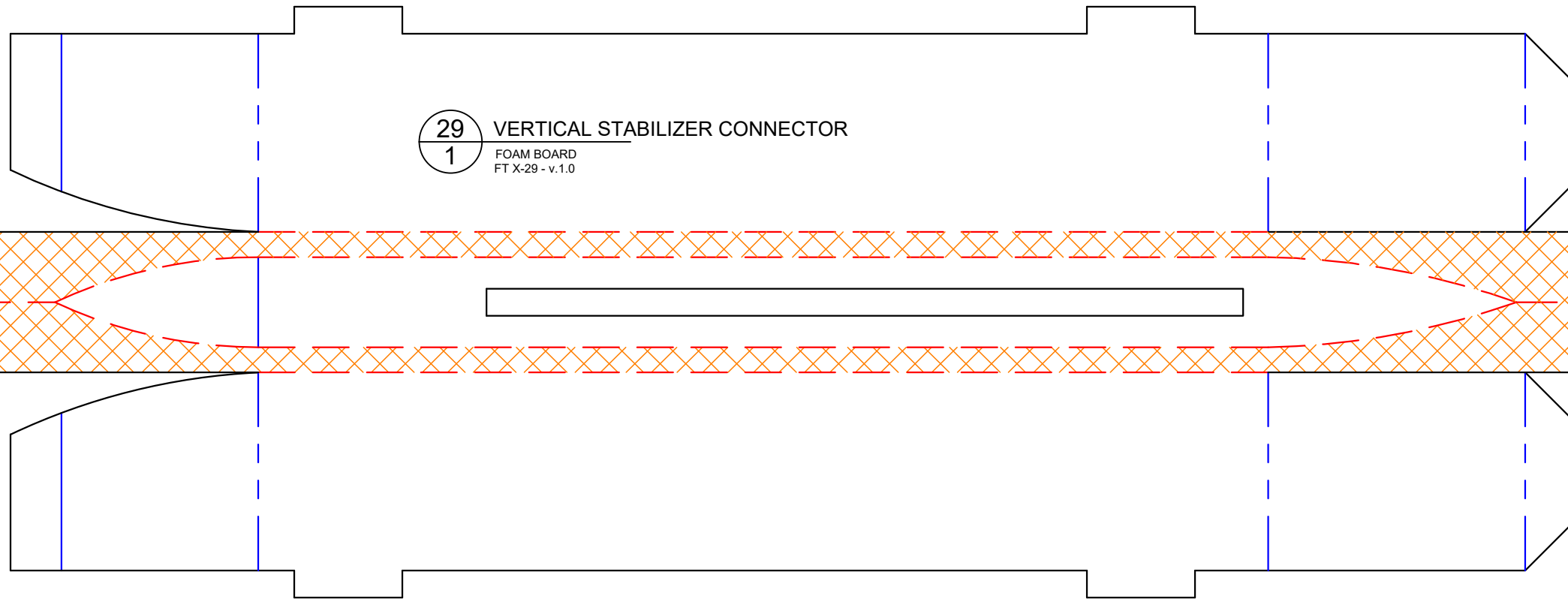

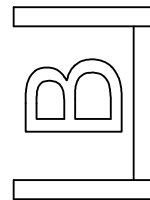
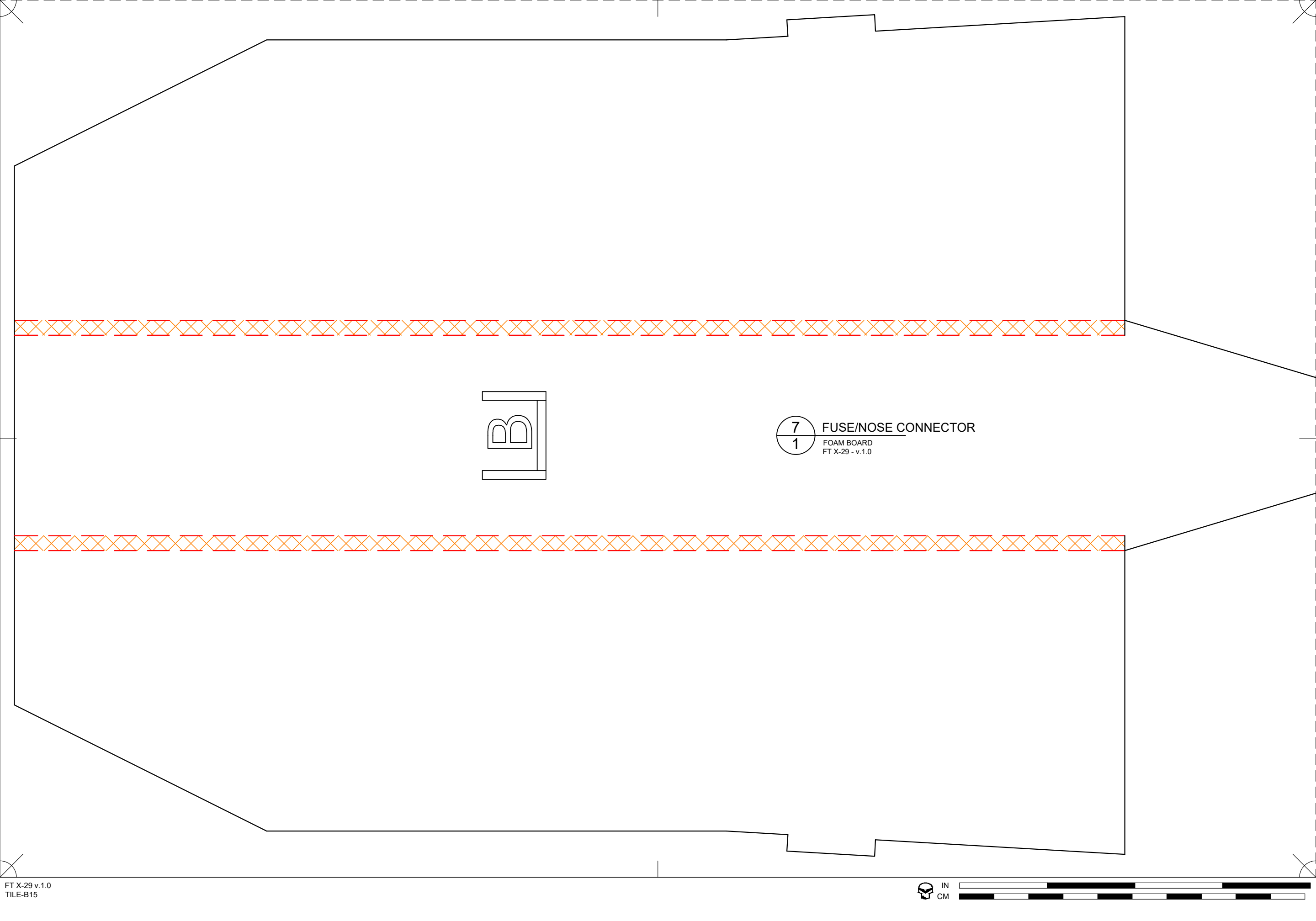

7 FUSE/NOSE CONNECTOR
1 FOAM BOARD
FT X-29 - v.1.0

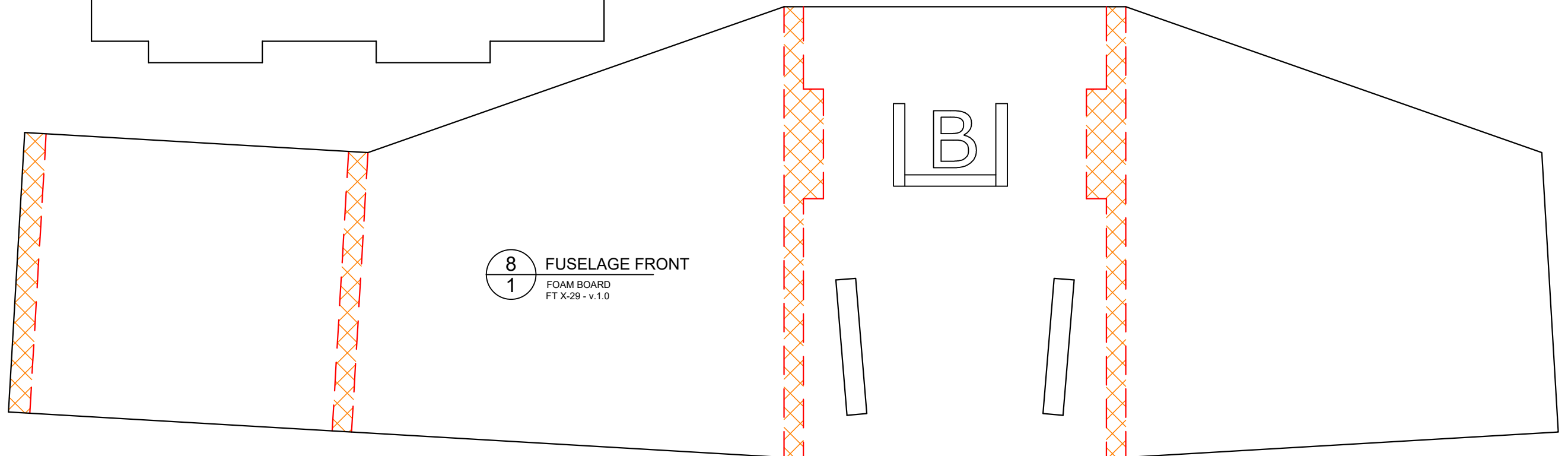
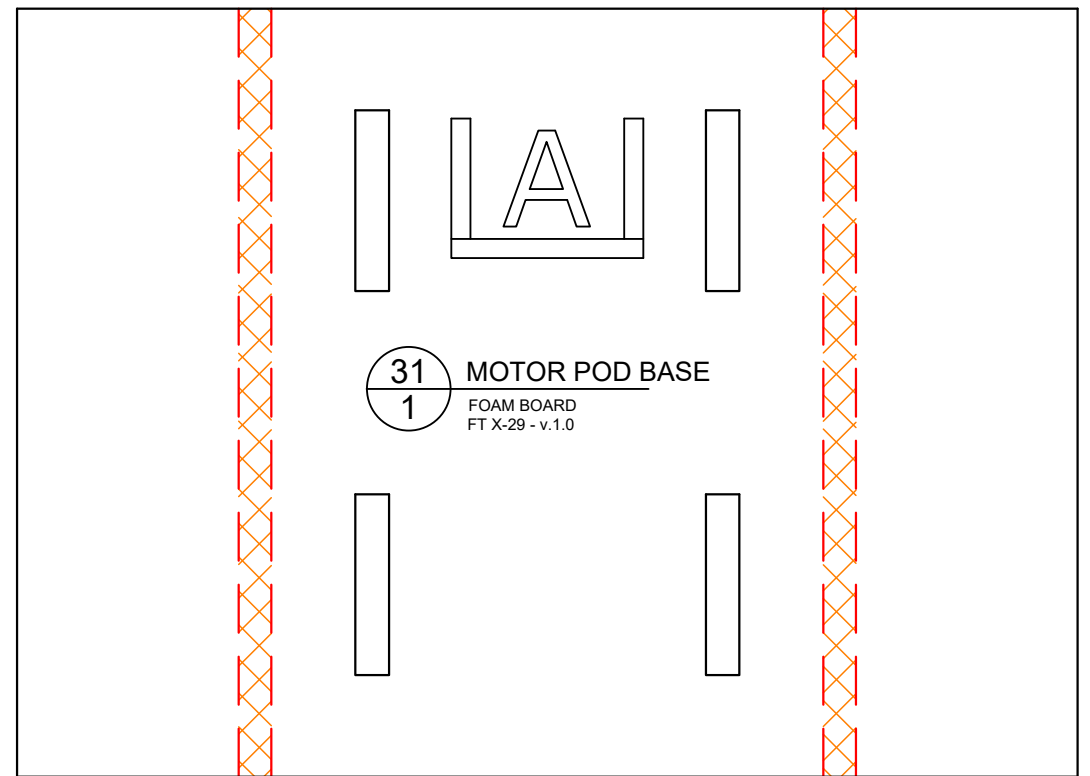
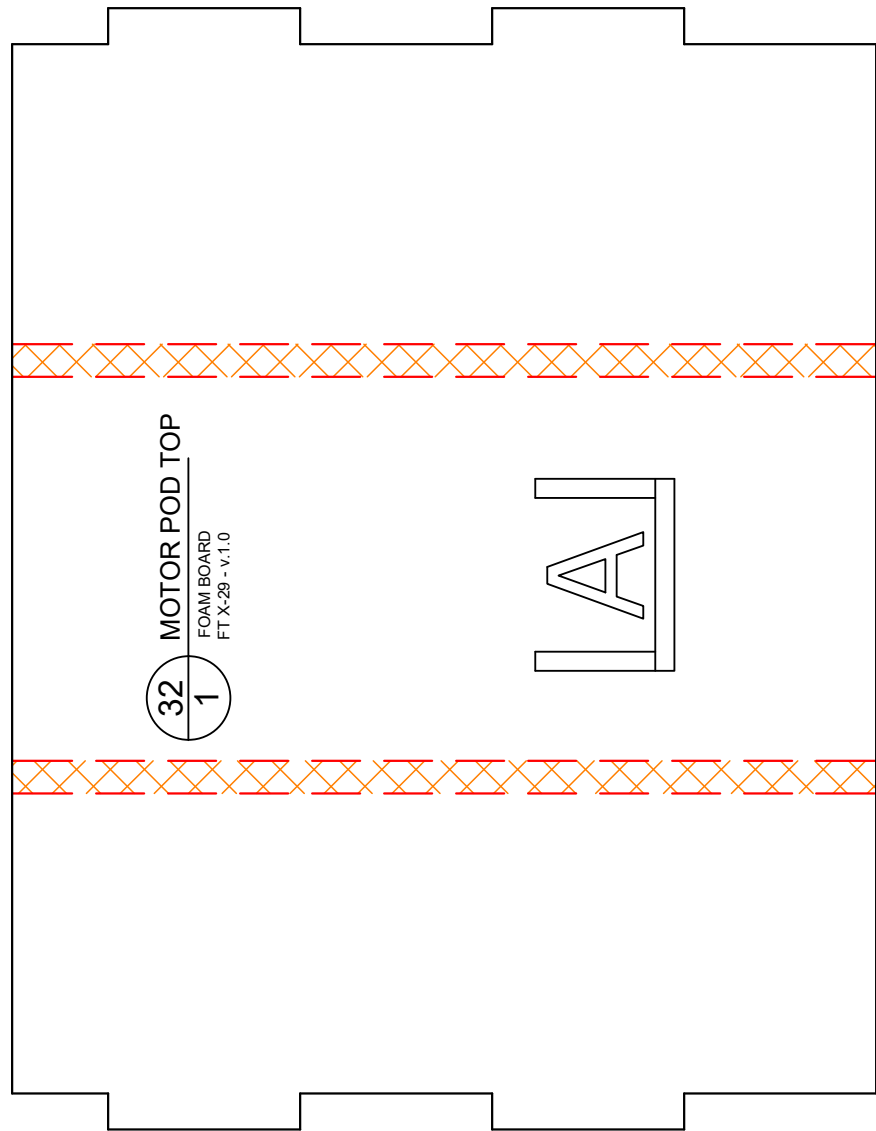

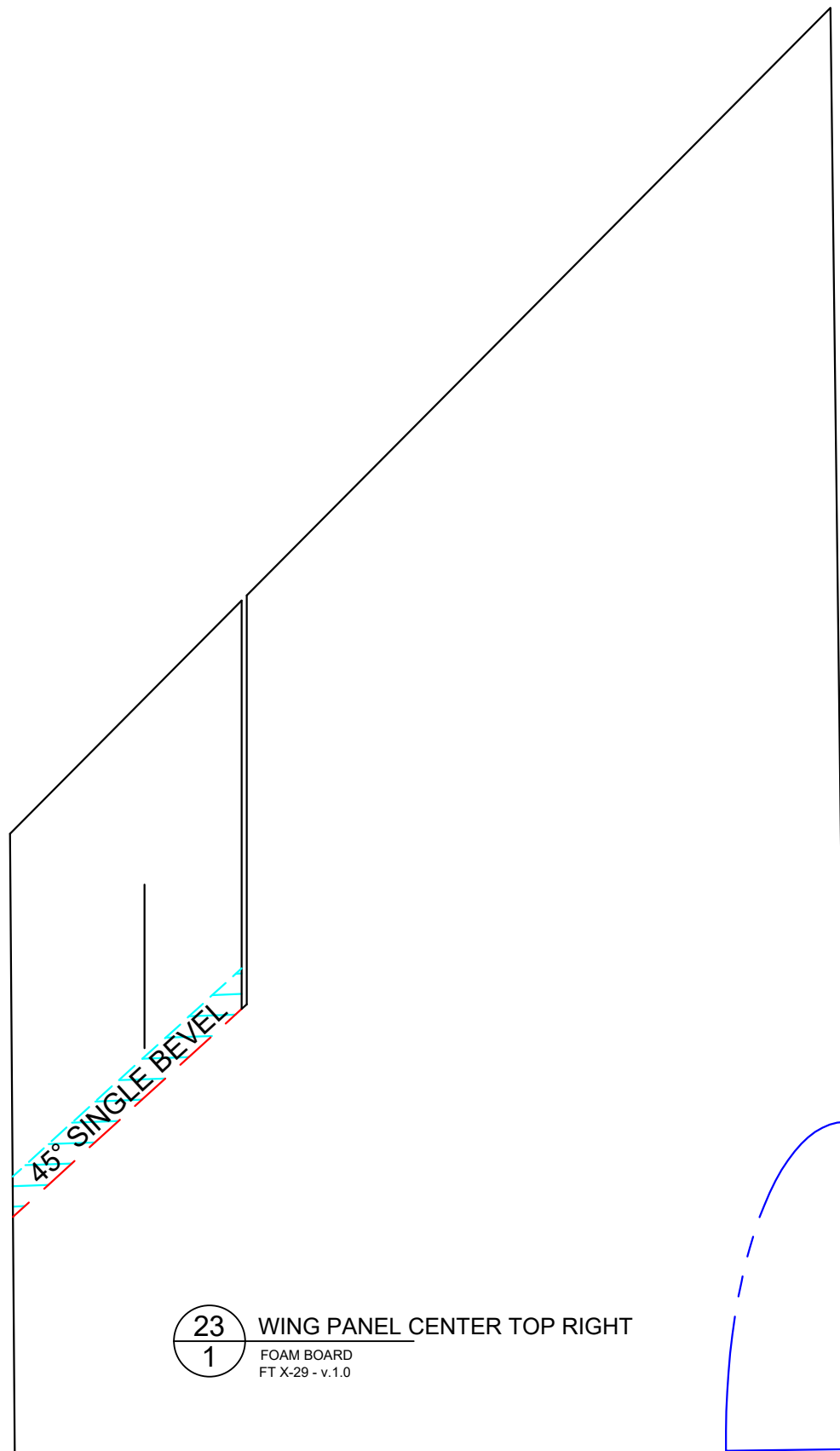

23 WING PANEL CENTER TOP RIGHT
1 FOAM BOARD
FT X-29 - v.1.0

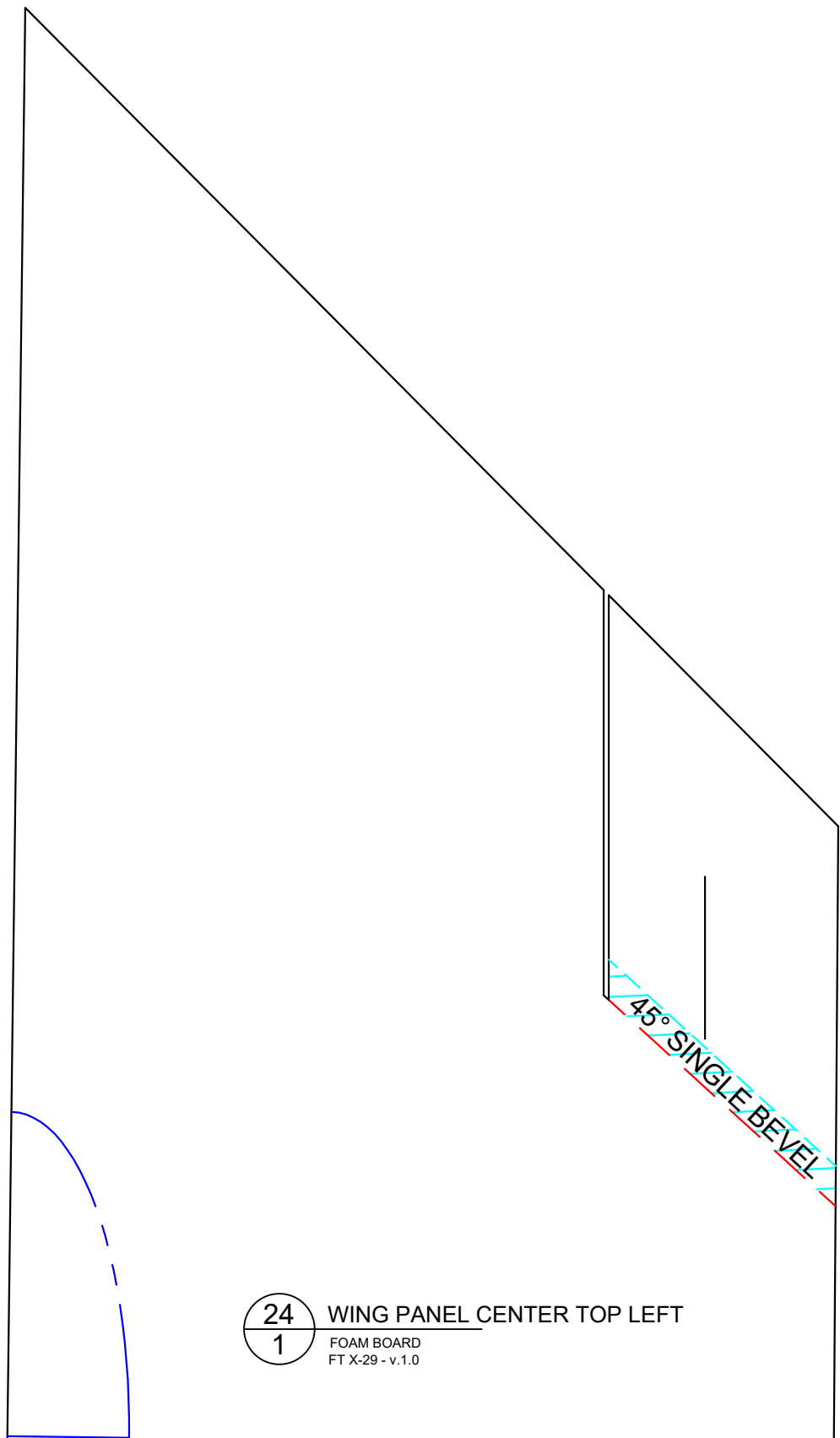

24 WING PANEL CENTER TOP LEFT
1 FOAM BOARD
FT X-29 - v.1.0

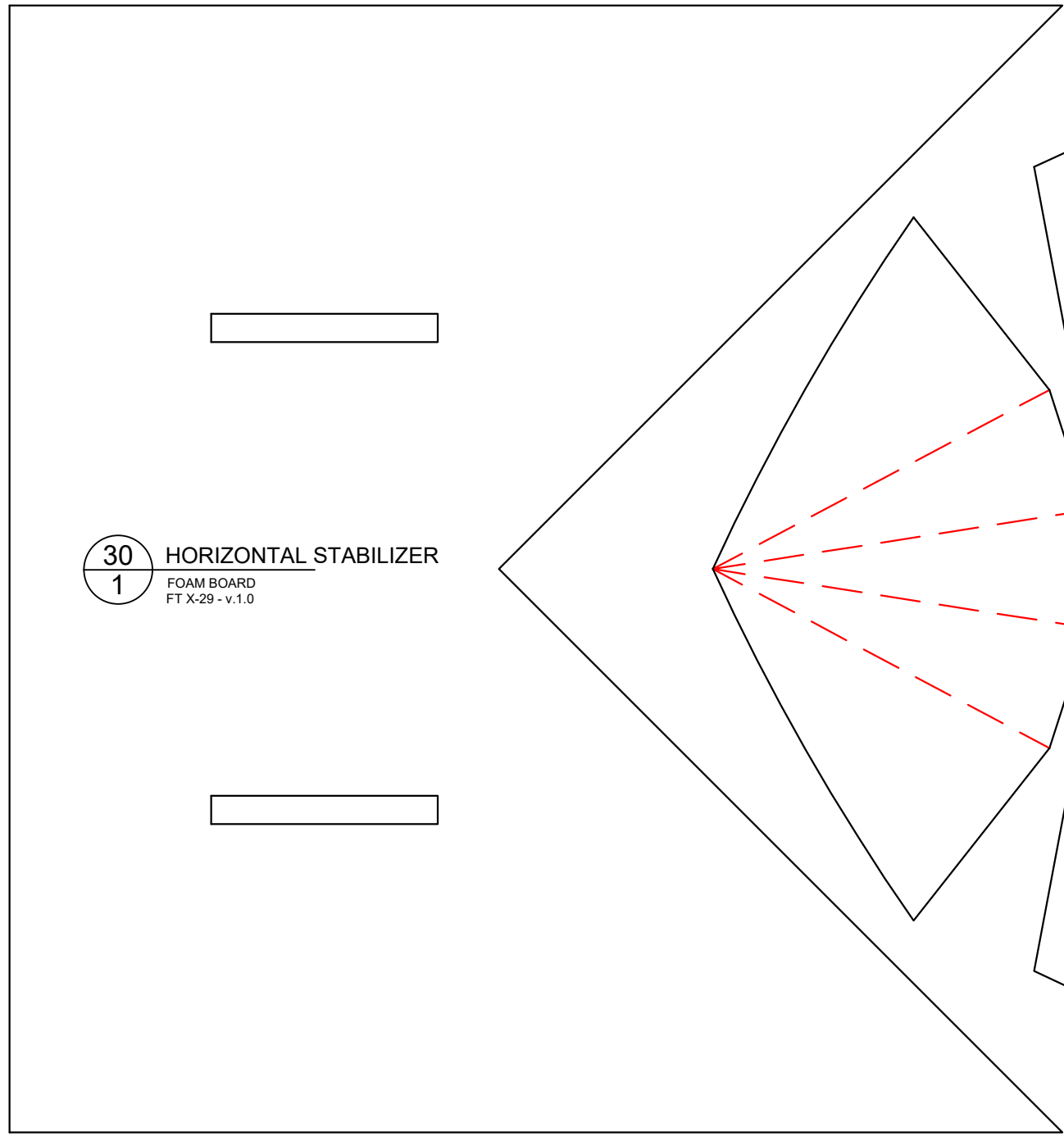

30
1 HORIZONTAL STABILIZER
FOAM BOARD
FT X-29 - v.1.0

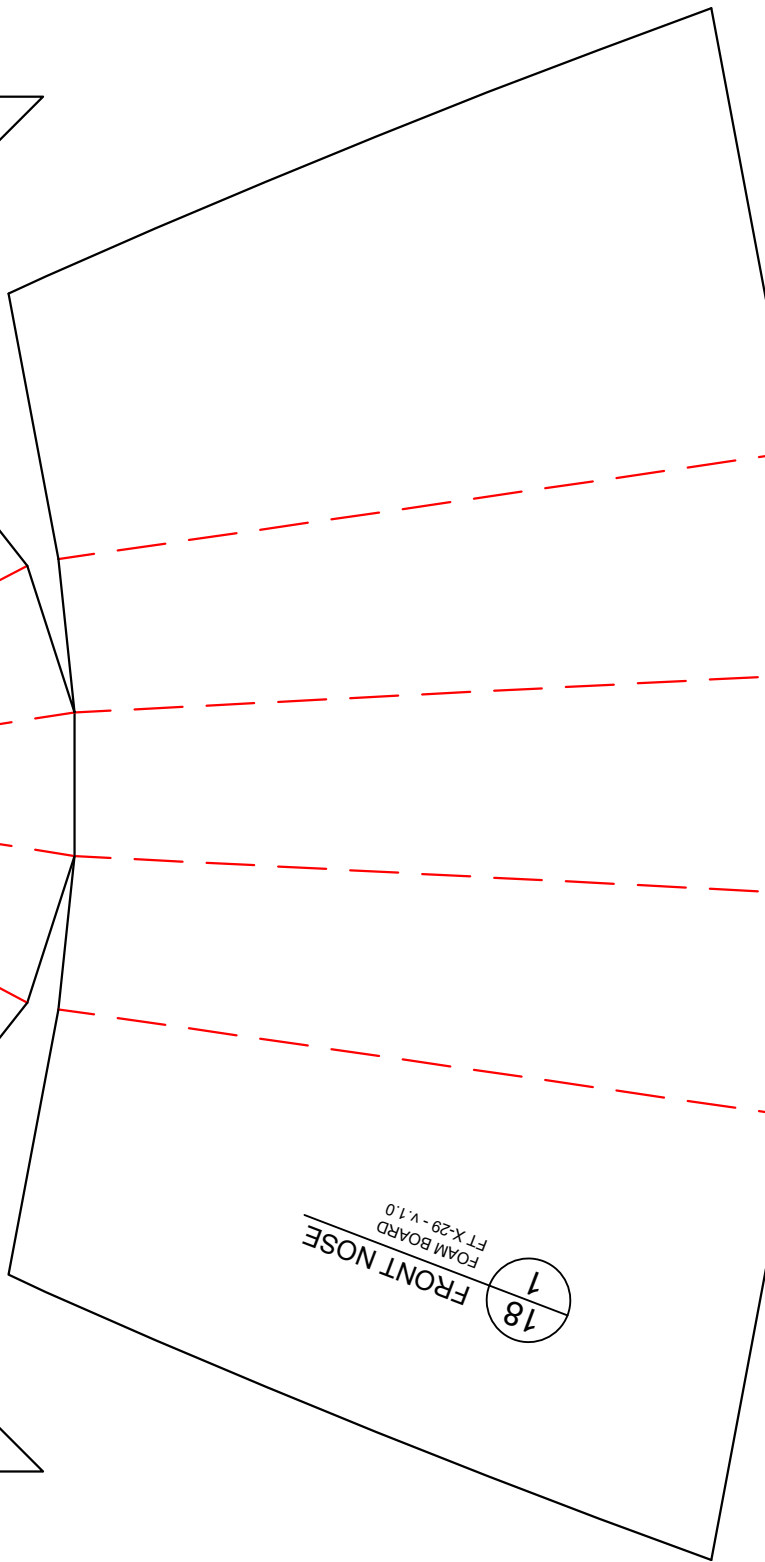

18
1 FRONT NOSE
FOAM BOARD
FT X-29 - v.1.0

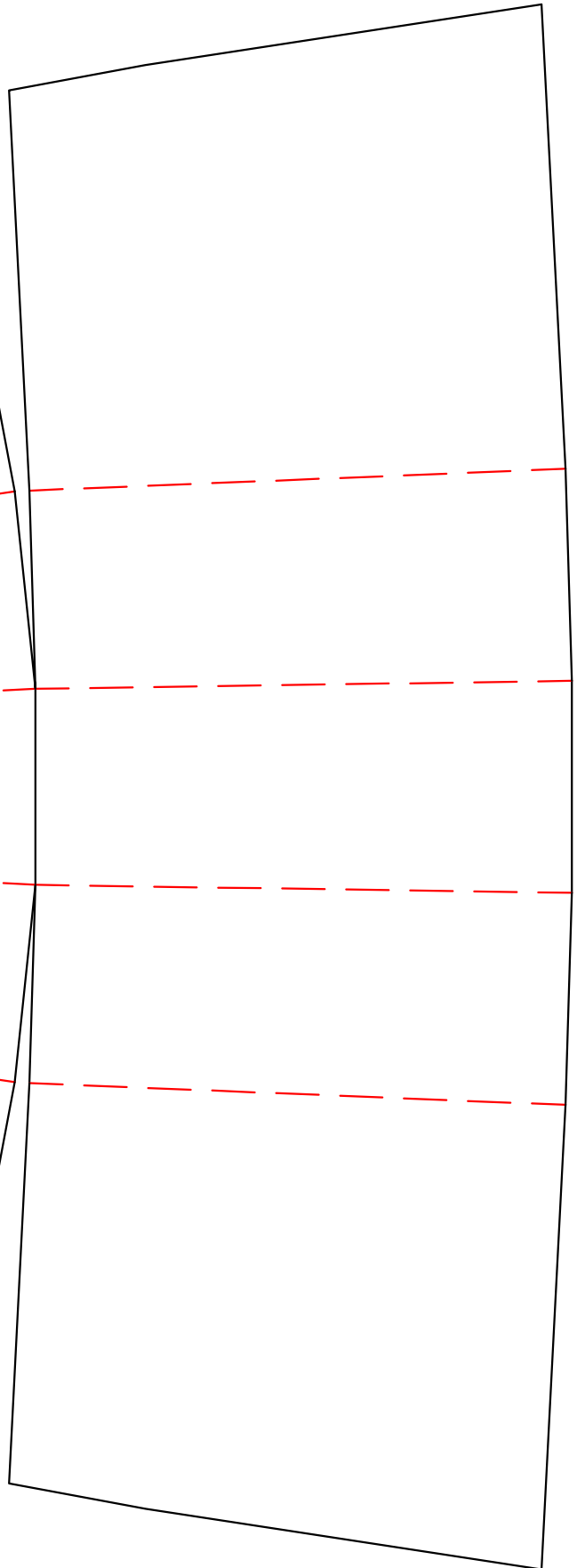

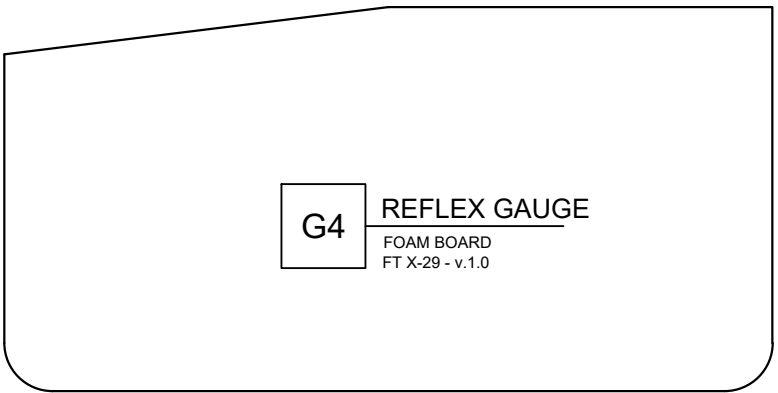
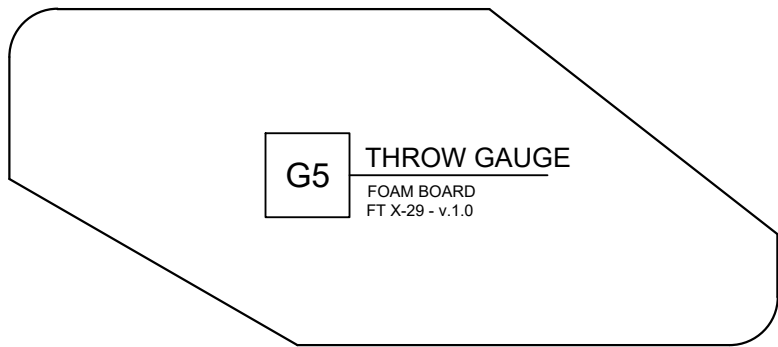
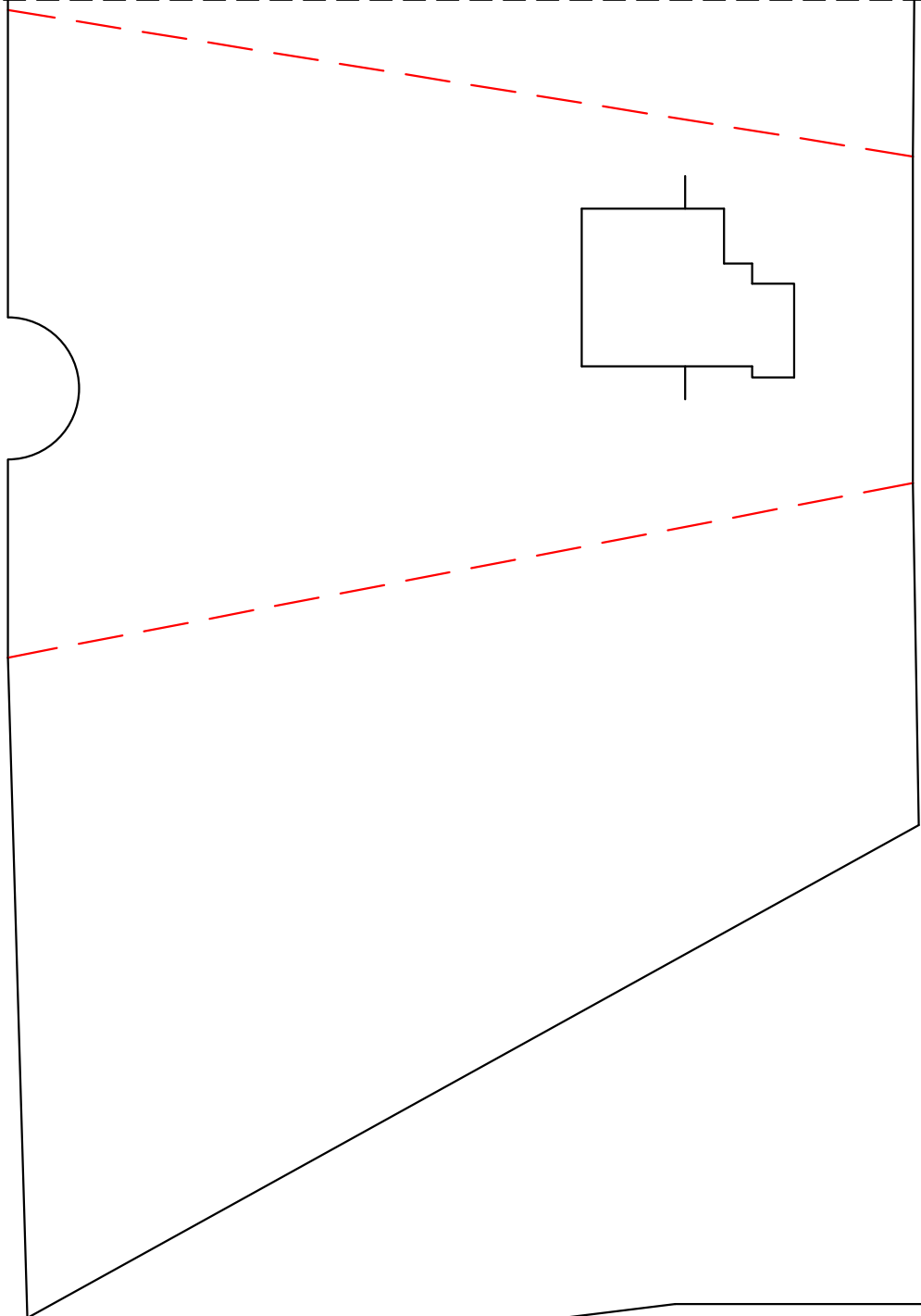
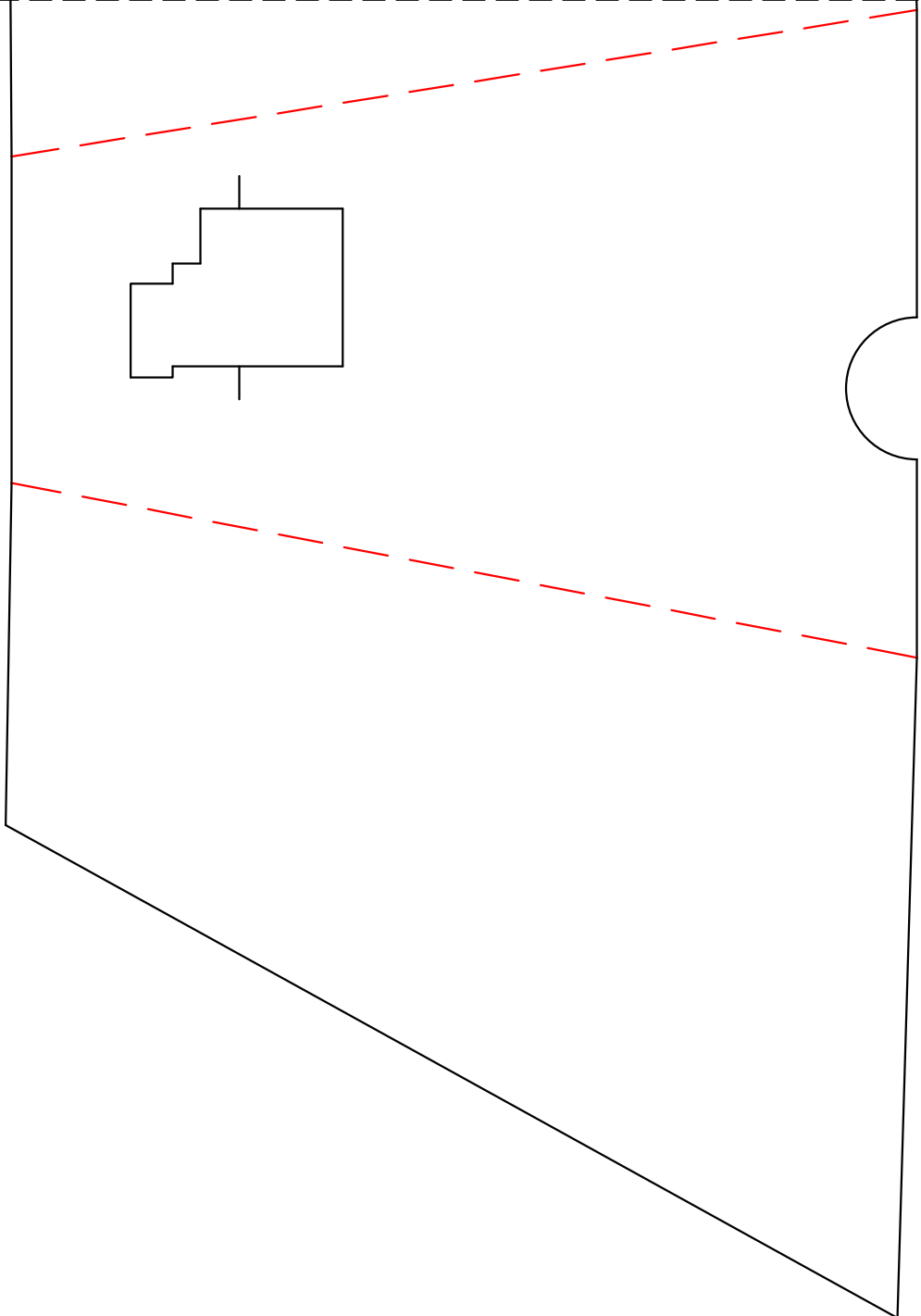

10 FUSELAGE CENTER/REAR
1 FOAM BOARD
FT X-29 - v.1.0

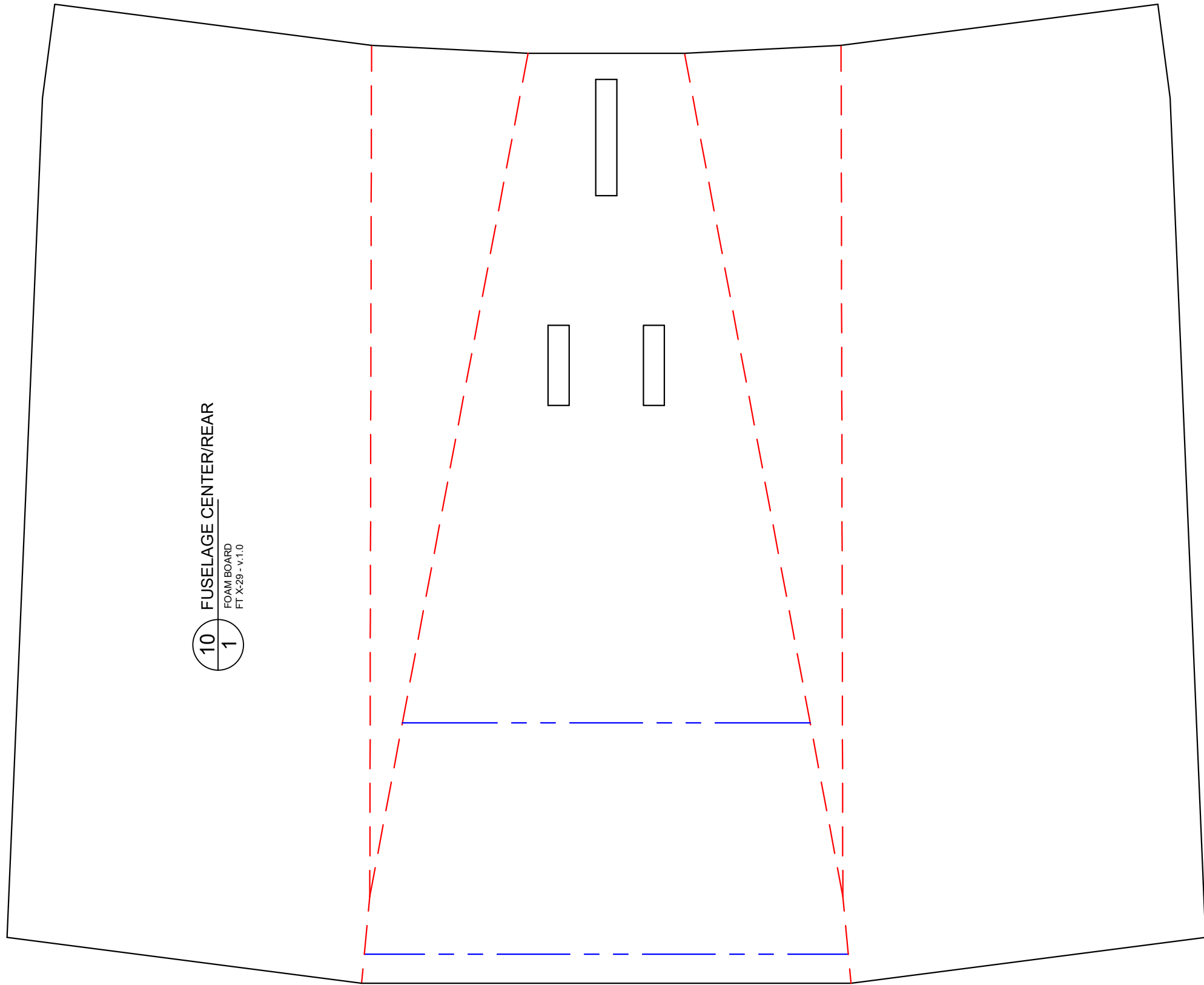

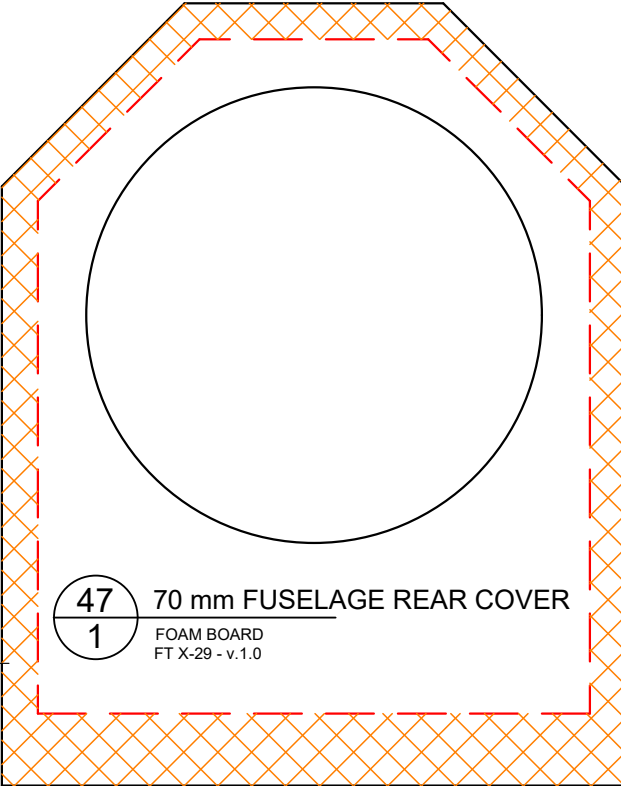

47 70 mm FUSELAGE REAR COVER
1 FOAM BOARD
FT X-29 - v.1.0

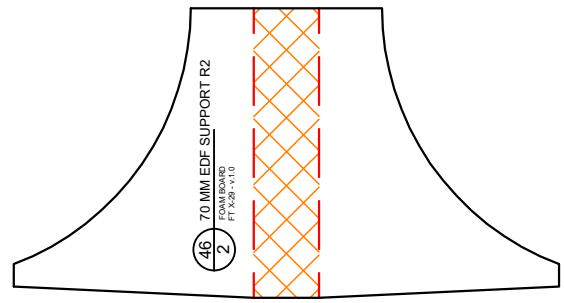

46 70 MM EDF SUPPORT R2
2 FOAM BOARD
FT X-29 - v.1.0

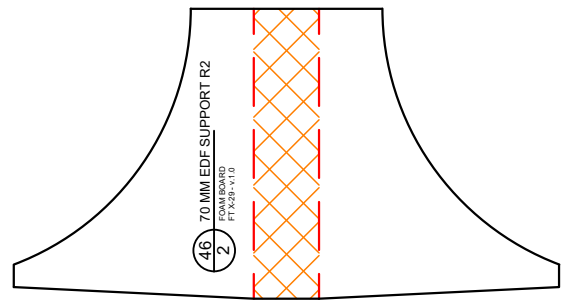

46 70 MM EDF SUPPORT R2
2 FOAM BOARD
FT X-29 - v.1.0

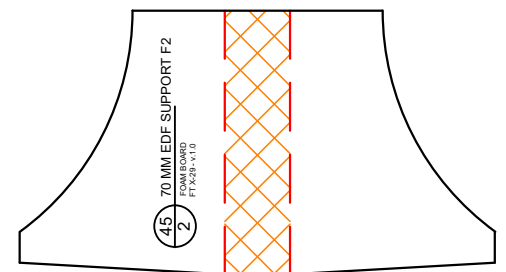

45 70 MM EDF SUPPORT F2
2 FOAM BOARD
FT X-29 - v.1.0

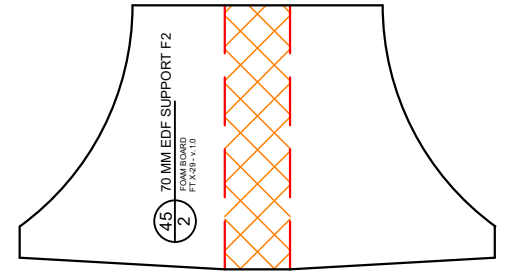

45 70 MM EDF SUPPORT F2
2 FOAM BOARD
FT X-29 - v.1.0

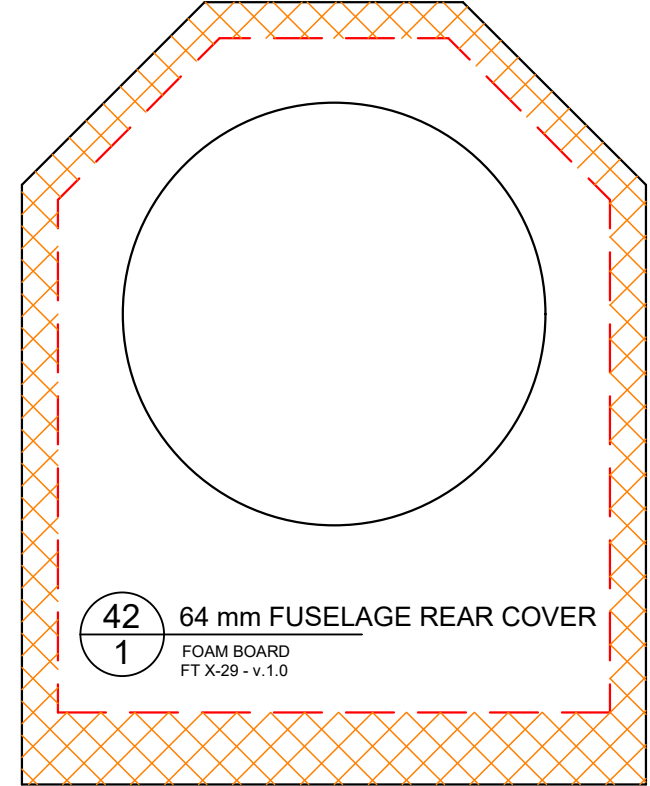

42 64 mm FUSELAGE REAR COVER
1 FOAM BOARD
FT X-29 - v.1.0

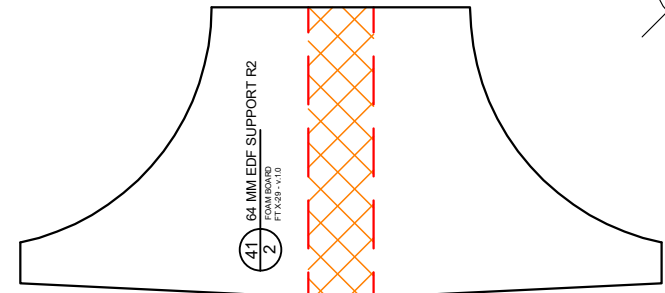

41 64 MM EDF SUPPORT R2
2 FOAM BOARD
FT X-29 - v.1.0

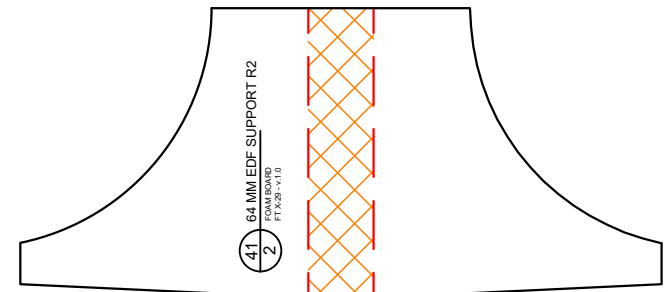

41 64 MM EDF SUPPORT R2
2 FOAM BOARD
FT X-29 - v.1.0

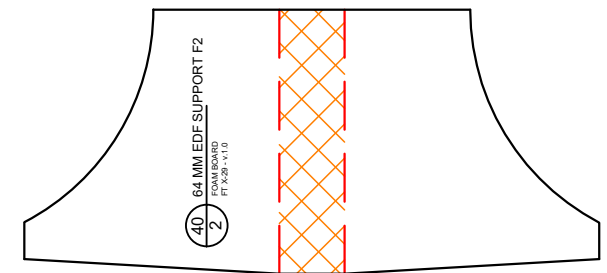

40 64 MM EDF SUPPORT F2
2 FOAM BOARD
FT X-29 - v.1.0

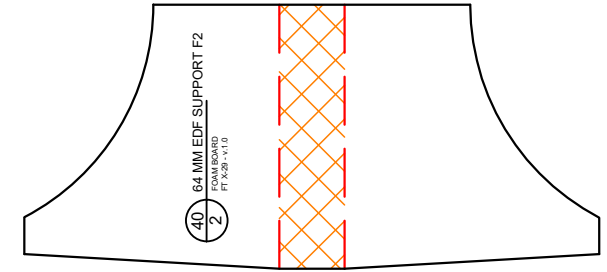

40 64 MM EDF SUPPORT F2
2 FOAM BOARD
FT X-29 - v.1.0

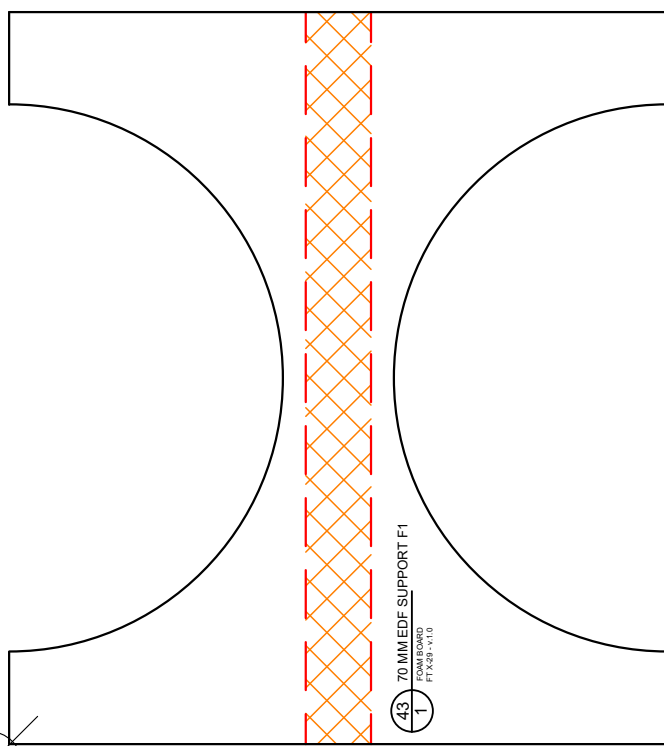

43 70 MM EDF SUPPORT F1
1 FOAM BOARD
FT X-29 - v.1.0

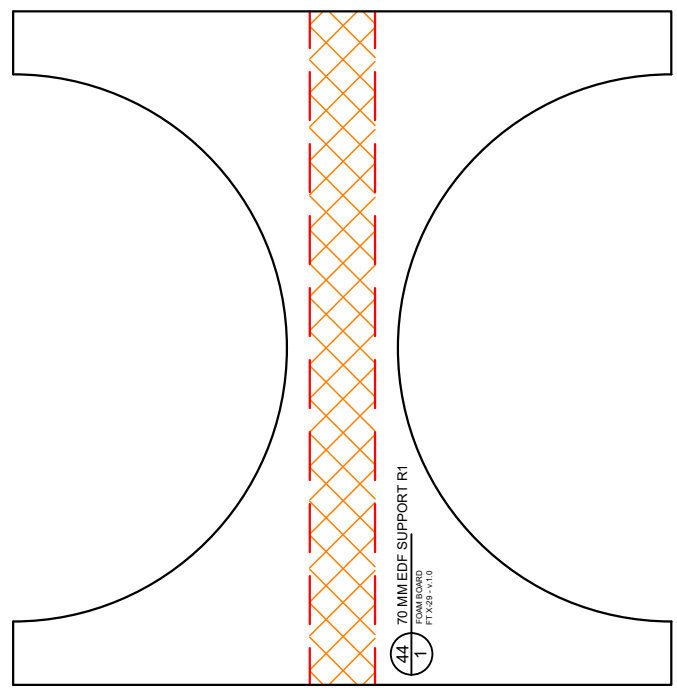

44 70 MM EDF SUPPORT R1
1 FOAM BOARD
FT X-29 - v.1.0

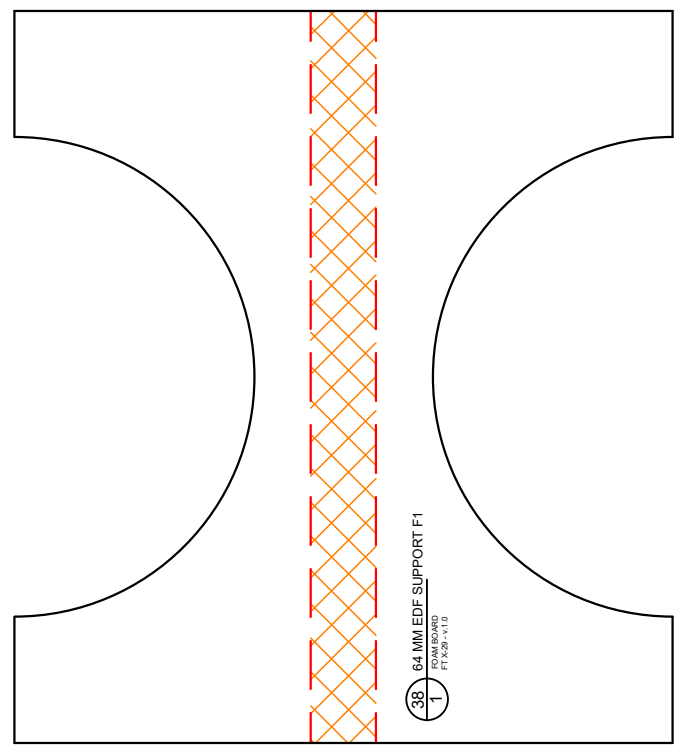

38 64 MM EDF SUPPORT F1
1 FOAM BOARD
FT X-29 - v.1.0

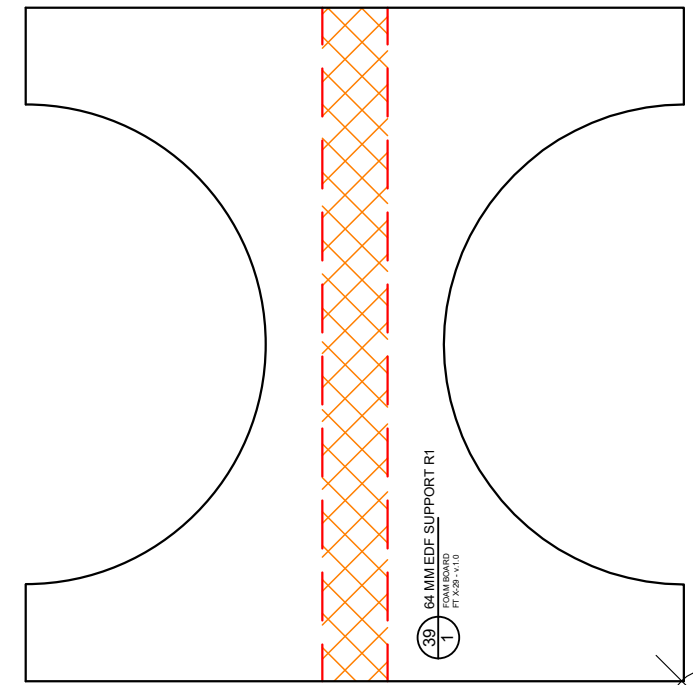

39 64 MM EDF SUPPORT R1
1 FOAM BOARD
FT X-29 - v.1.0

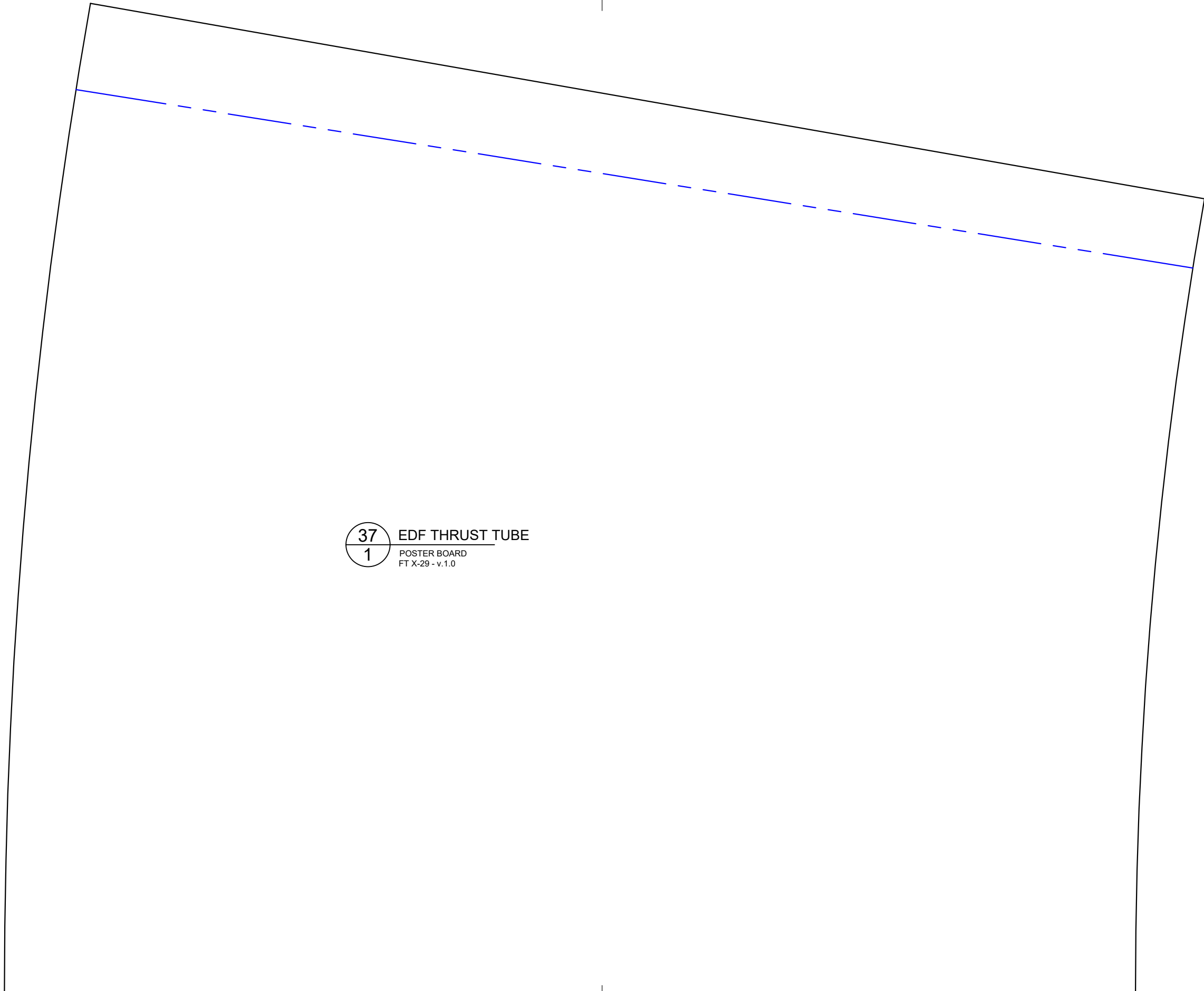

37 EDF THRUST TUBE
1 POSTER BOARD
FT X-29 - v.1.0